



US00D880378S

(12) **United States Design Patent** (10) **Patent No.:** **US D880,378 S**
Lu (45) **Date of Patent:** **** Apr. 7, 2020**

(54) **AUTOMOBILE LOWER GRILLE**
(71) Applicant: **Turn 5, Inc.**, Paoli, PA (US)
(72) Inventor: **Shunguo Lu**, Danyang (CN)
(73) Assignee: **Turn 5, Inc.**, Paoli, PA (US)
(**) Term: **15 Years**
(21) Appl. No.: **29/666,385**
(22) Filed: **Oct. 12, 2018**
(51) **LOC (12) Cl.** **12-16**
(52) **U.S. Cl.**
USPC **D12/163**
(58) **Field of Classification Search**
USPC D12/86, 90-92, 163, 169, 171, 173, 181,
D12/184, 196, 216, 388
CPC B60R 19/52; B60K 11/08; B62D 25/08;
B62B 9/16
See application file for complete search history.

(56) **References Cited**

U.S. PATENT DOCUMENTS

D562,196 S * 2/2008 Saito D12/163
D678,824 S * 3/2013 Behmer D12/163
D722,923 S * 2/2015 George D12/163
D736,123 S * 8/2015 Hammoud D12/163
D738,798 S * 9/2015 Morikawa D12/163
D773,960 S * 12/2016 Jeon D12/92
D775,003 S * 12/2016 Pevovar D12/163
D797,013 S * 9/2017 Sahara D12/163
D808,870 S * 1/2018 Zavatski D12/163
D814,981 S * 4/2018 Villamizar D12/163
D817,234 S * 5/2018 Park D12/163
D819,511 S * 6/2018 Ishii D12/163
D827,508 S * 9/2018 Whitla D12/163
10,183,573 B1 * 1/2019 Klop B60K 11/08
D845,185 S * 4/2019 Behmer F16D 65/847
D12/163
D851,550 S * 6/2019 Mack D12/163
D852,687 S * 7/2019 Nakagawa D12/163

D853,898 S * 7/2019 Bucher D12/163
D855,502 S * 8/2019 Behmer D12/163
D855,503 S * 8/2019 Blanski D12/163
D857,567 S * 8/2019 Blanski D12/163
D861,546 S * 10/2019 Dewitt D12/163
(Continued)

OTHER PUBLICATIONS

Burkart, Tom. "DIY Car Mods Series—\$20 Honeycomb Grille Insert." *Car_Revs_Daily*, published Apr. 3, 2014 (Retrieved from the Internet Aug. 29, 2019). Internet URL: <https://www.car-revs-daily.com/2014/04/03/diy-car-mods-series-20-honeycomb-grille-insert-from-the-ford-crown-vic/> (Year: 2014).*
(Continued)

Primary Examiner — Jack Reickel
Assistant Examiner — Rachel A Voorhies
(74) *Attorney, Agent, or Firm* — Schott, P.C.

(57) **CLAIM**

The ornamental design for the automobile lower grille, as shown and described.

DESCRIPTION

FIG. 1 is a top perspective view of the automobile lower grille of the present invention;
FIG. 2 is a bottom perspective view thereof;
FIG. 3 is a front elevation view thereof;
FIG. 4 is a rear elevation view thereof;
FIG. 5 is a top view thereof;
FIG. 6 is a bottom view thereof;
FIG. 7 is a right side view thereof;
FIG. 8 is a left side view thereof; and,
FIG. 9 is a perspective view thereof in an exemplary automobile.
The broken lines are provided for the purpose of illustrating environmental structure(s) and form no part of the claimed design.

1 Claim, 6 Drawing Sheets

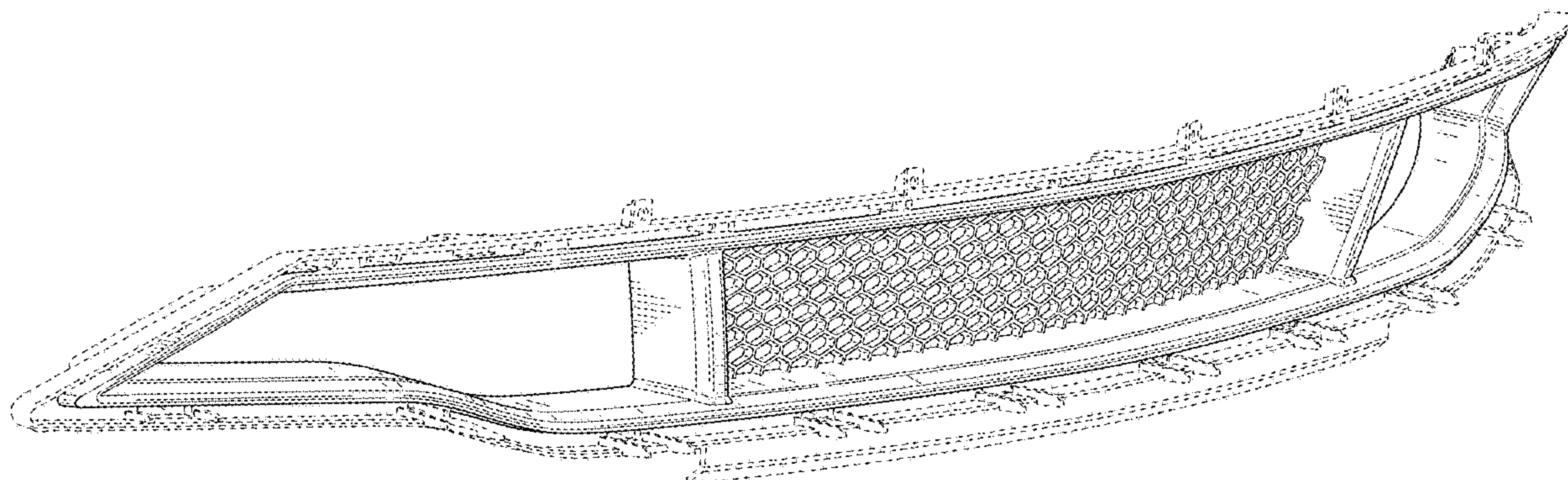

(56)

References Cited

U.S. PATENT DOCUMENTS

D863,132 S * 10/2019 Thurber D12/163
D863,133 S * 10/2019 Woodhouse D12/163
D863,138 S * 10/2019 Kim D12/163
D864,051 S * 10/2019 Luke D12/163
D866,414 S * 11/2019 Bucher D12/169
D867,229 S * 11/2019 Morikawa D12/163
2008/0079271 A1 * 4/2008 Maruko B60R 19/52
293/102
2018/0313418 A1 * 11/2018 Titus F16D 65/847

OTHER PUBLICATIONS

Cuztom_Tuning. "Upper + Lower Grille Set." Amazon.com, published Jun. 11, 2015 (Retrieved from the Internet Aug. 30, 2019). Internet URL: <https://www.amazon.com/...019-Mustang-Bullitt-Textured-Honeyconnb/dp/B07N9B6R77/ref=sr_1_3?keywords=mustang+2018-2019+lower+grille&qid=1567185520&s=automotive> (Year: 2015).*

Ogbac, Stefan. "11 Significant Changes to the Refreshed 2018 Ford Mustang." Motor Trend, published Jan. 18, 2017 (Retrieved from the Internet Aug. 30, 2019). Internet URL: <<https://www.motortrend.com/news/11-significant-changes-refreshed-2018-ford-mustang/>> (Year: 2017).*

* cited by examiner

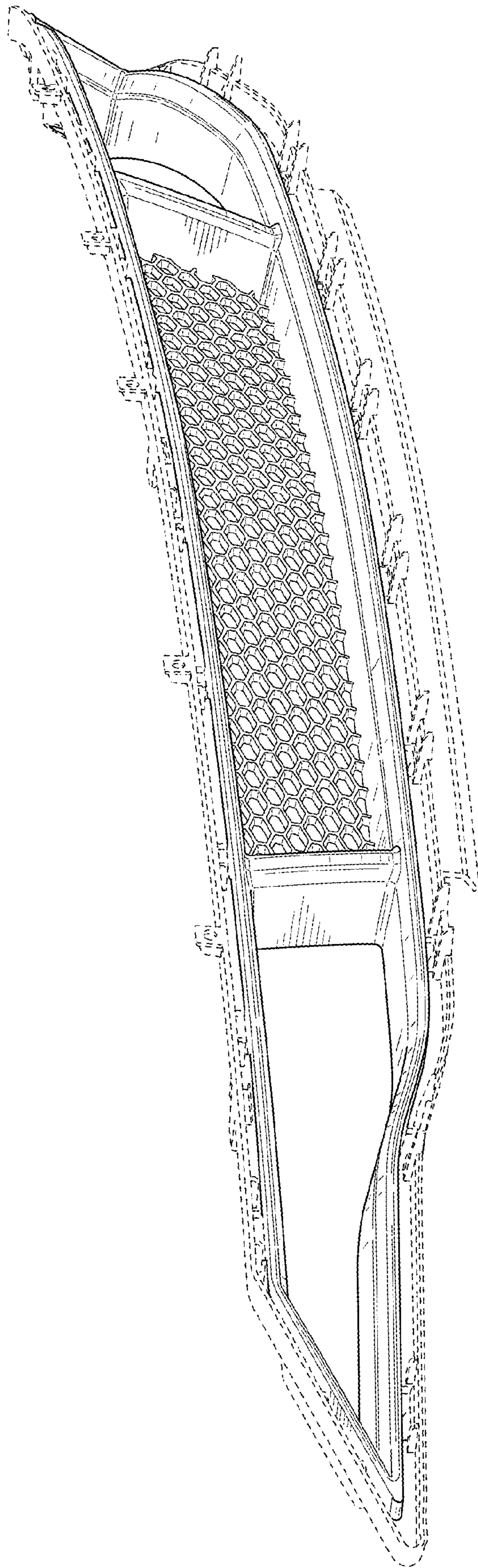

FIG. 1

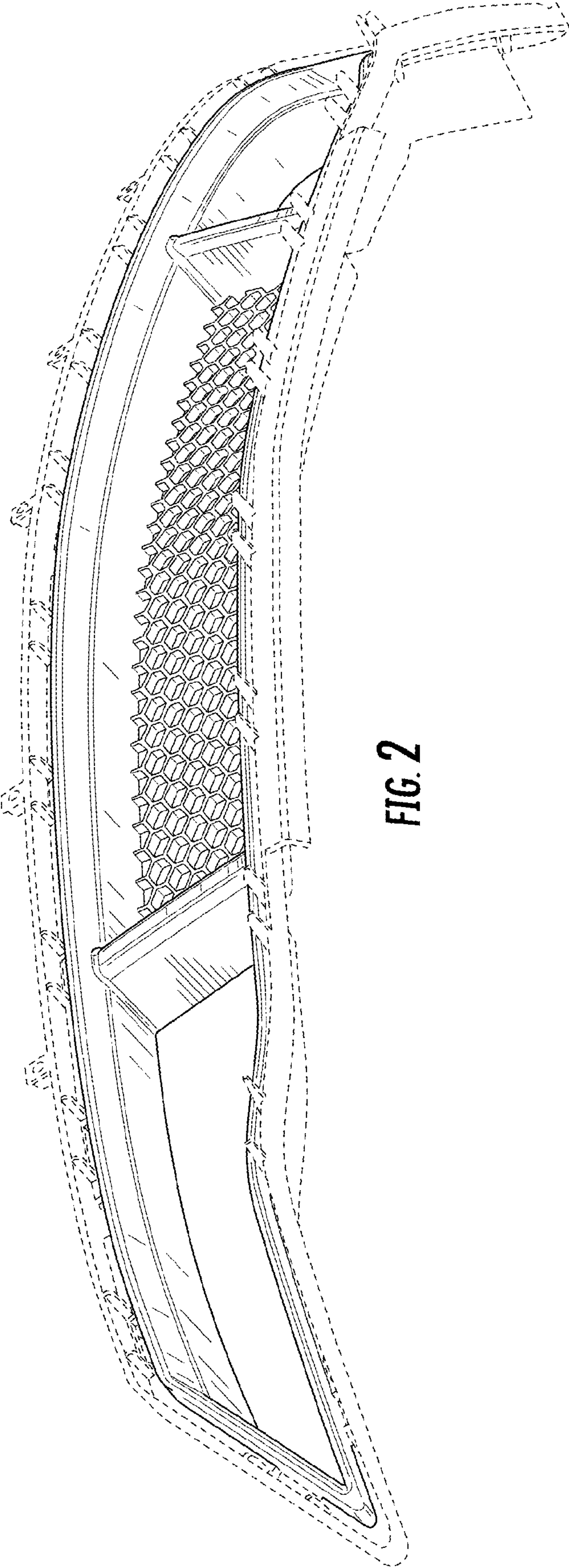

FIG. 2

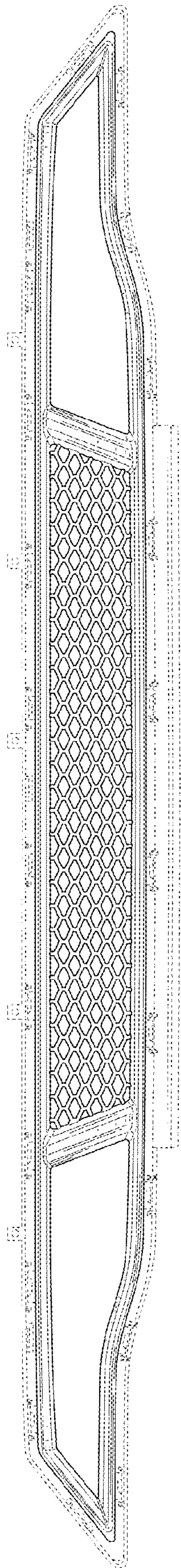

FIG. 3

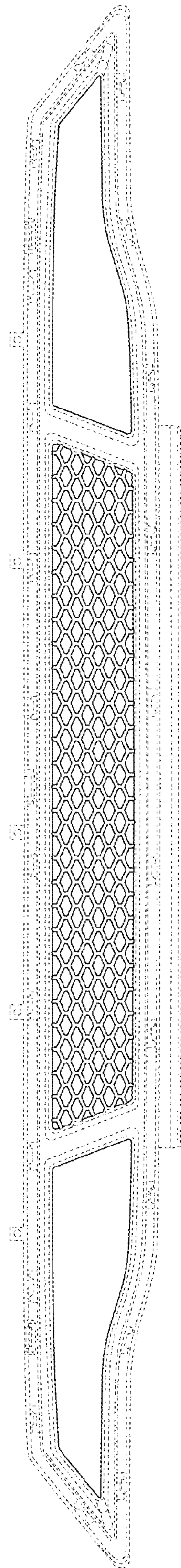

FIG. 4

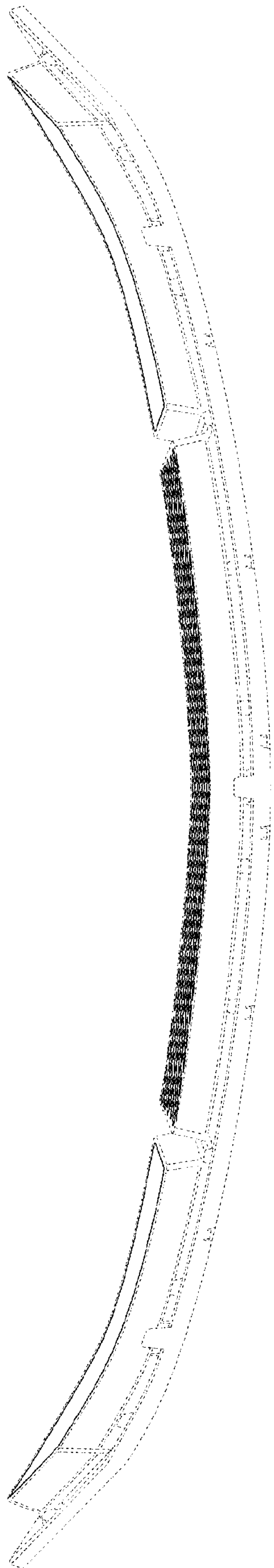

FIG. 5

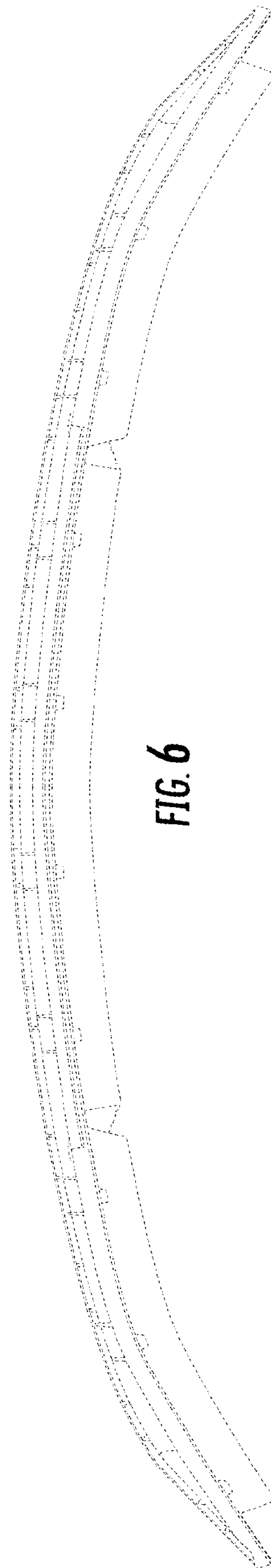

FIG. 6

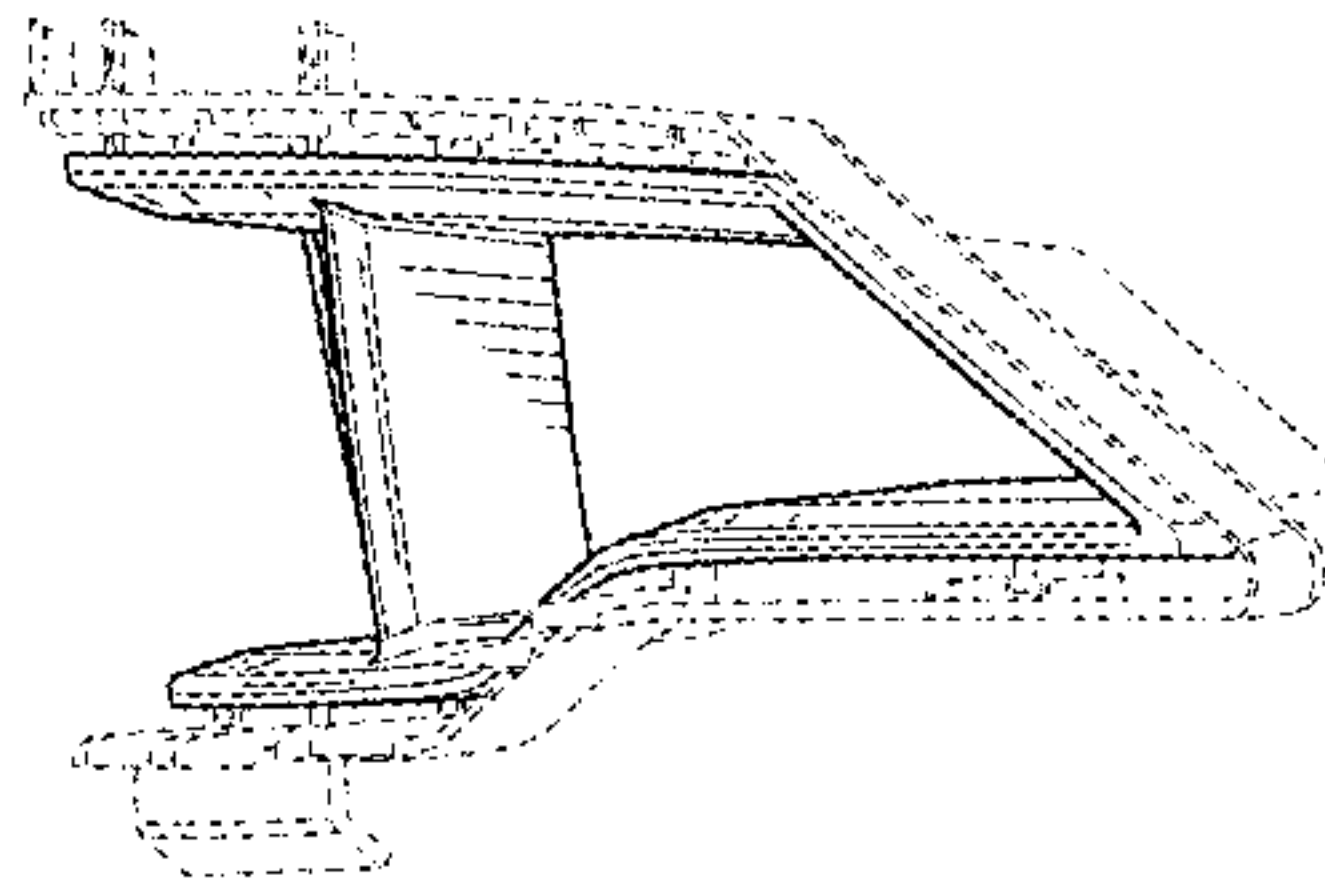

FIG. 7

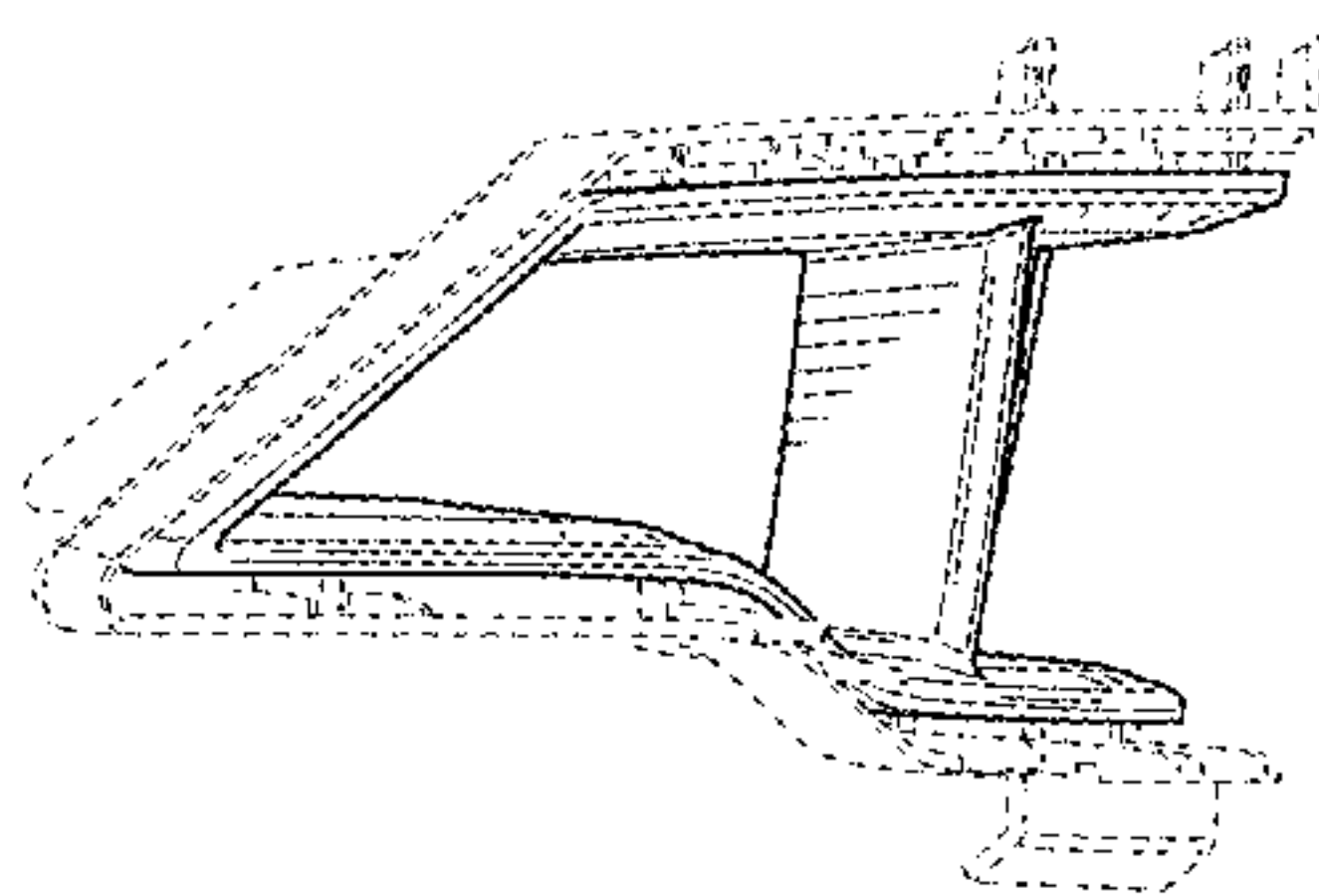

FIG. 8

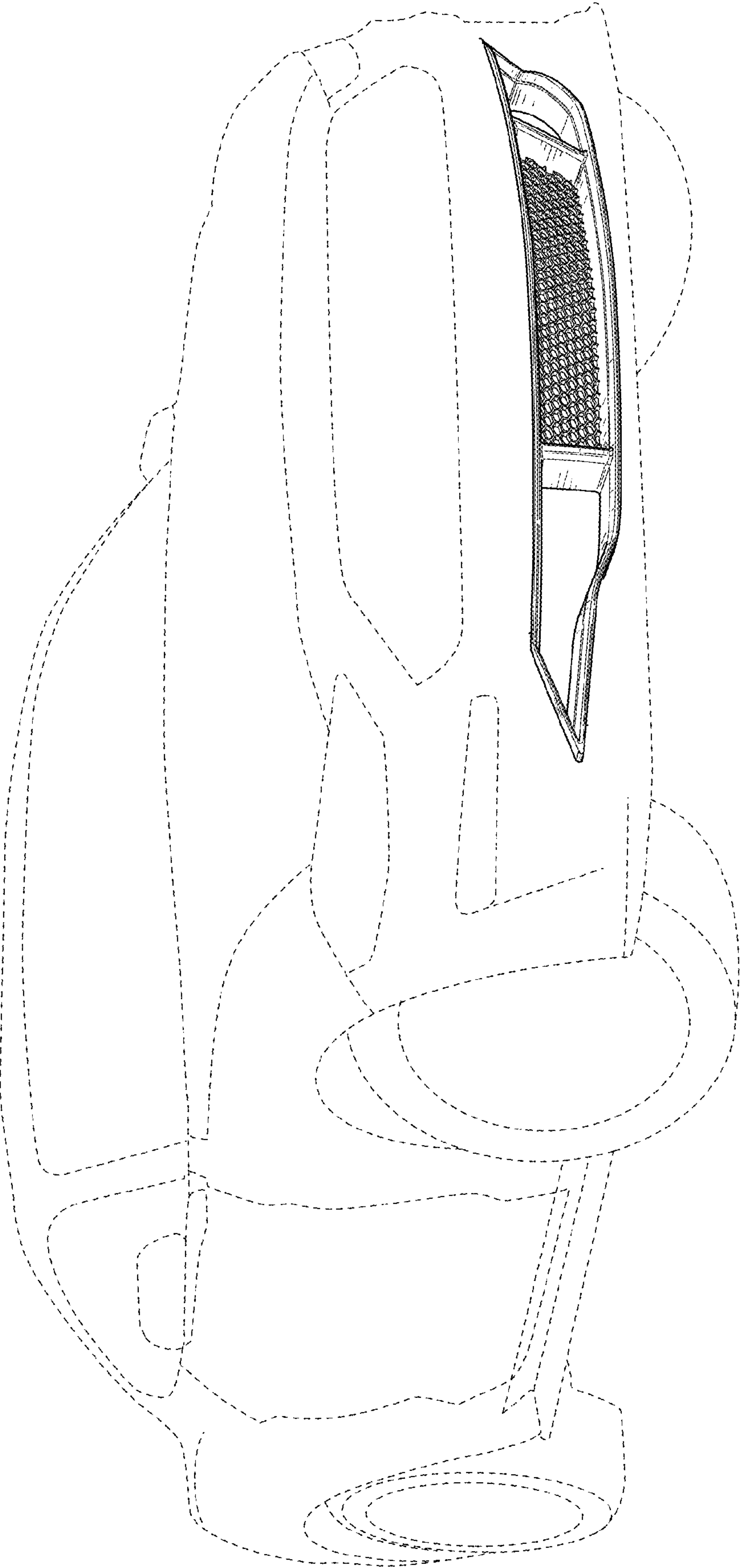

FIG. 9