



US00D880315S

(12) **United States Design Patent** (10) **Patent No.:** **US D880,315 S**
Brown et al. (45) **Date of Patent:** **** Apr. 7, 2020**

(54) **CUPCAKE PACKAGE**

(71) Applicant: **Pinnpack Packaging, LLC**, Oxnard, CA (US)

(72) Inventors: **Dean Brown**, Oxnard, CA (US); **Ira Maroofian**, Oxnard, CA (US)

(73) Assignee: **PINNPack PACKAGING LLC**, Oxnard, CA (US)

(**) Term: **15 Years**

(21) Appl. No.: **29/667,900**

(22) Filed: **Oct. 25, 2018**

(51) **LOC (12) Cl.** **09-03**

(52) **U.S. Cl.**
USPC **D9/761**

(58) **Field of Classification Search**
USPC D9/414, 418, 420–426, 429–432, 503, D9/504, 737, 756–762; D7/538, D7/540–542, 550.1, 553.1–553.5, 554.1, D7/554.3, 554.4, 555, 557, 584, 586, 601, D7/602, 610, 611, 614, 615, 701, 703, D7/707, 708; D3/206, 273, 20, 283, 284, D3/295, 302, 309–315; 220/500, 507, 220/508, 553, 555, 556; 229/120.02, 229/120.07, 406, 407, 906, 904; 206/521.1, 521.15, 561, 443
CPC B65B 31/028; B65B 19/34; B65D 1/30; B65D 1/34; B65D 2581/055; B65D 81/34; B65D 1/36; B65D 81/3453; B65D 85/36; B65D 21/02; B65D 21/0206; B65D 71/40; B65D 71/50; B65D 43/162; B65D 1/00; B65D 43/021; B65D 2543/00194; B65D 2543/00296; B65D 2543/00509; B65D 2543/00101; B65D 2543/00537; B65D 2543/00555; B65D 2577/2066; B65D 2101/0015; B65D 2571/00277; B65D 21/0233; B65D 71/70; B65D 1/44; B65D 2581/3416; B65D

81/133; B65D 2543/00351; B65D 2543/002203; B65D 2543/00425; B65D 85/60; A61C 17/005; A61C 19/006; A23B 5/00

See application file for complete search history.

(56) **References Cited**

U.S. PATENT DOCUMENTS

D514,452 S *	2/2006	Enriquez	D9/759
D578,388 S *	10/2008	Lynn	D9/757
D592,076 S *	5/2009	Sipe	D9/420
D592,077 S *	5/2009	Sipe	D9/420
D661,601 S *	6/2012	Sanfilippo	D9/737
D761,127 S *	7/2016	Sellari	D9/756
D771,503 S *	11/2016	Brummer	D9/756
D792,240 S *	7/2017	Sellari	D9/756
D803,701 S *	11/2017	Sellari	D9/756
D806,576 S *	1/2018	Sellari	D9/761
2008/0308557 A1 *	12/2008	Kyle	B65D 43/0235 220/359.1
2019/0055082 A1 *	2/2019	Guirguis	B65D 85/36

* cited by examiner

Primary Examiner — W. A. Teddy Falloway
(74) *Attorney, Agent, or Firm* — Michael R Shevlin

(57) **CLAIM**

The ornamental design for a cupcake package, as shown and described.

DESCRIPTION

FIG. 1 is a perspective view of a cupcake package, showing my new design;
FIG. 2 is a front view thereof;
FIG. 3 is a rear view thereof;
FIG. 4 is a right side view thereof;
FIG. 5 is left side view thereof;
FIG. 6 is a top end view thereof; and,
FIG. 7 is a bottom end view thereof.

1 Claim, 7 Drawing Sheets

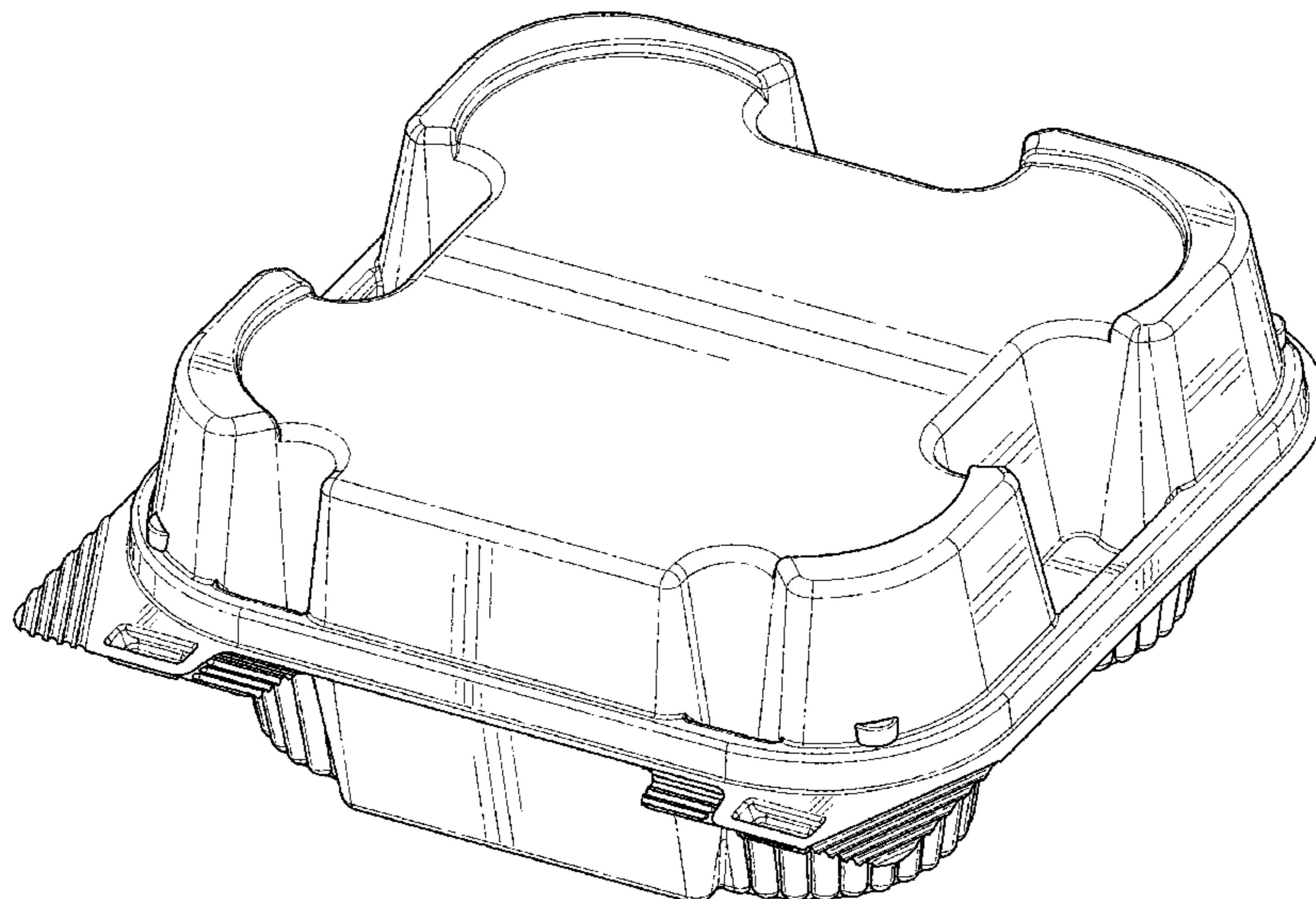

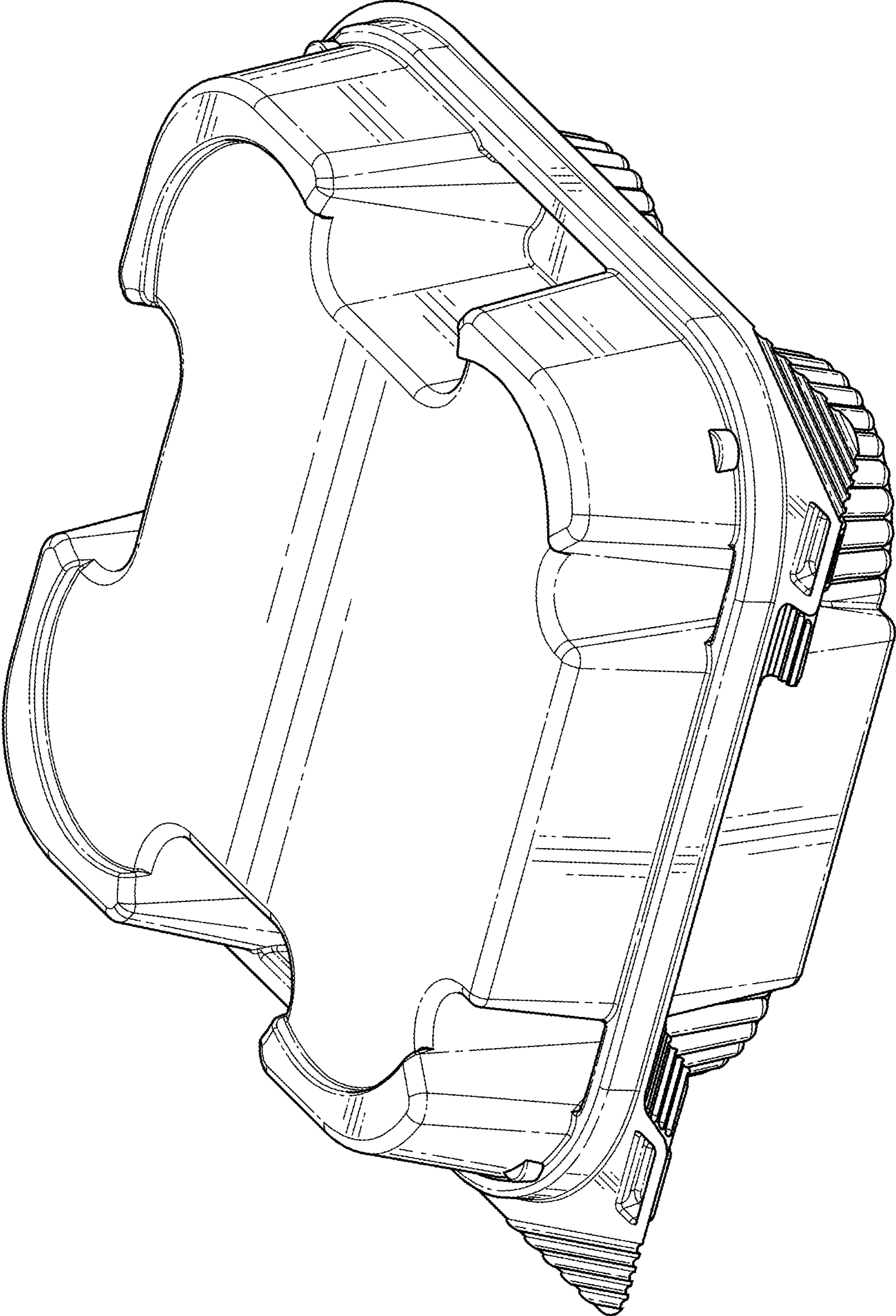

FIG. 1

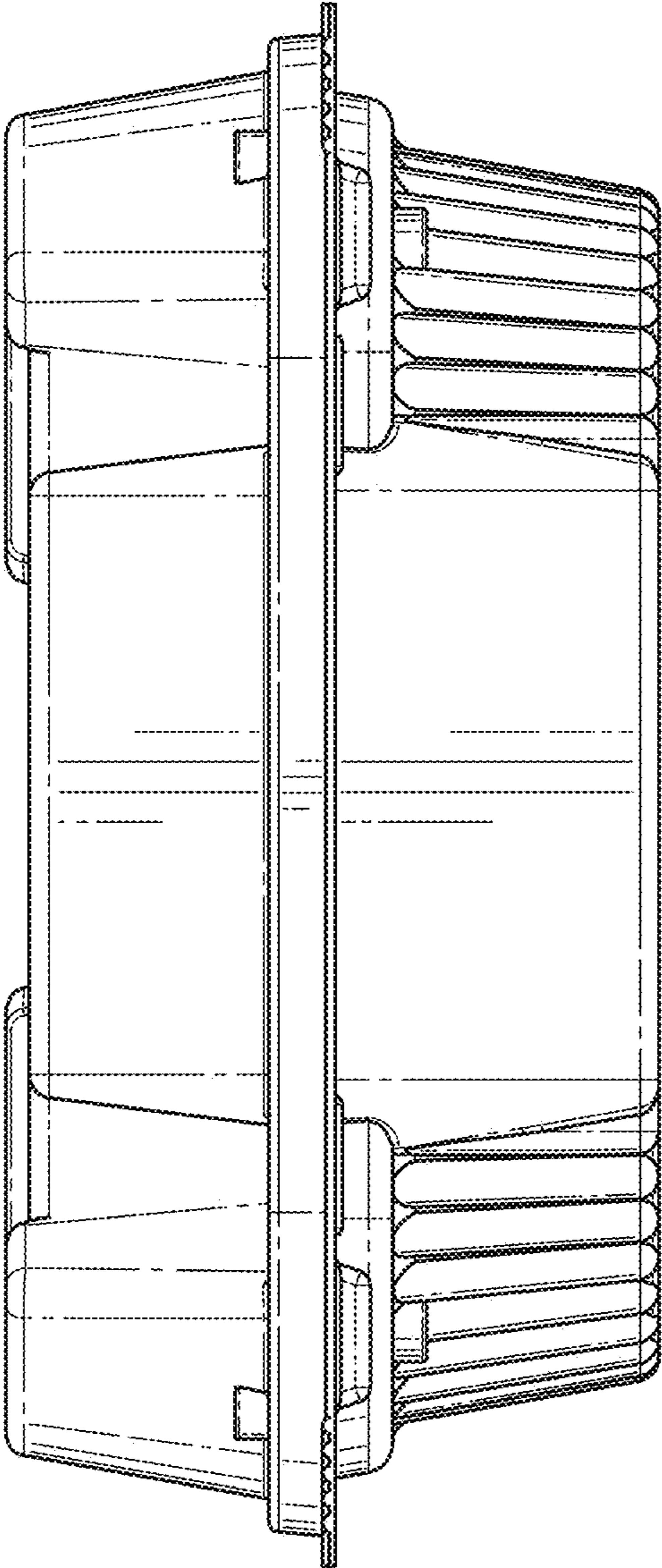

FIG. 2

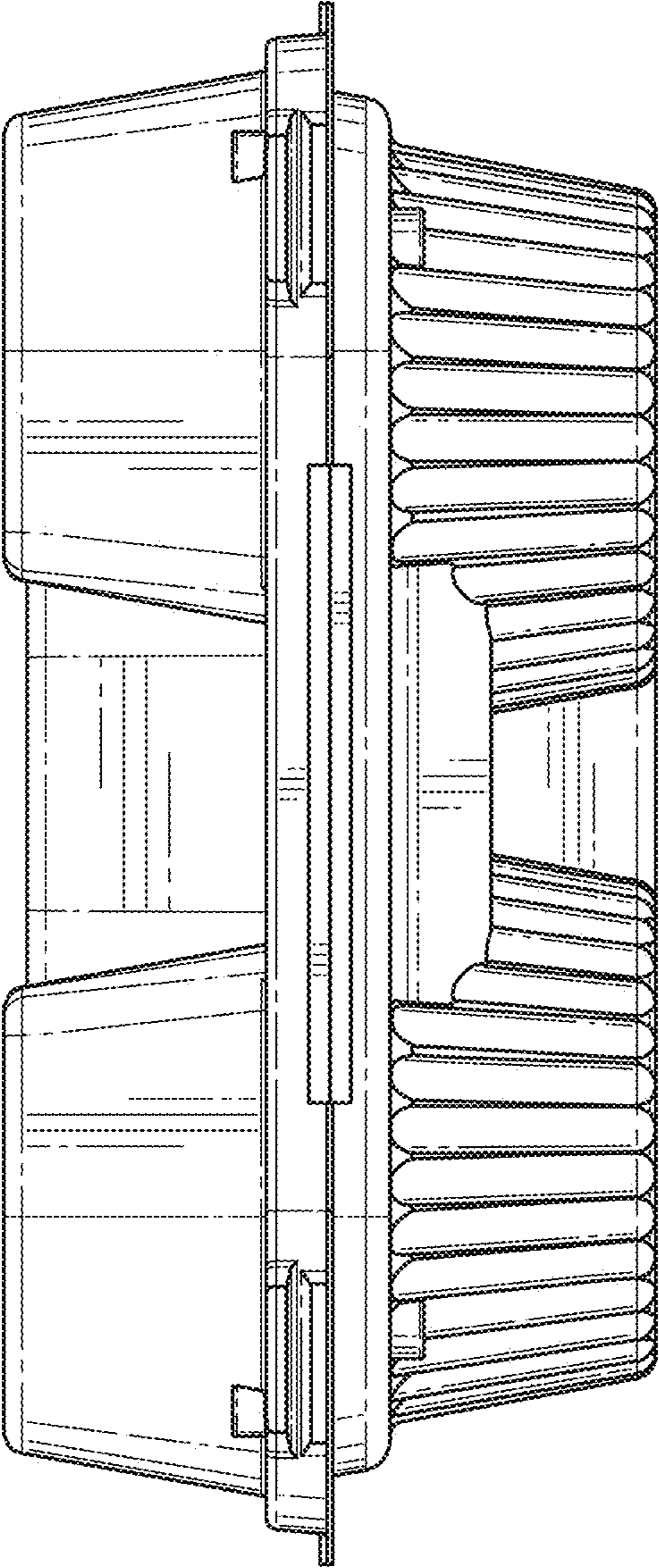

FIG. 3

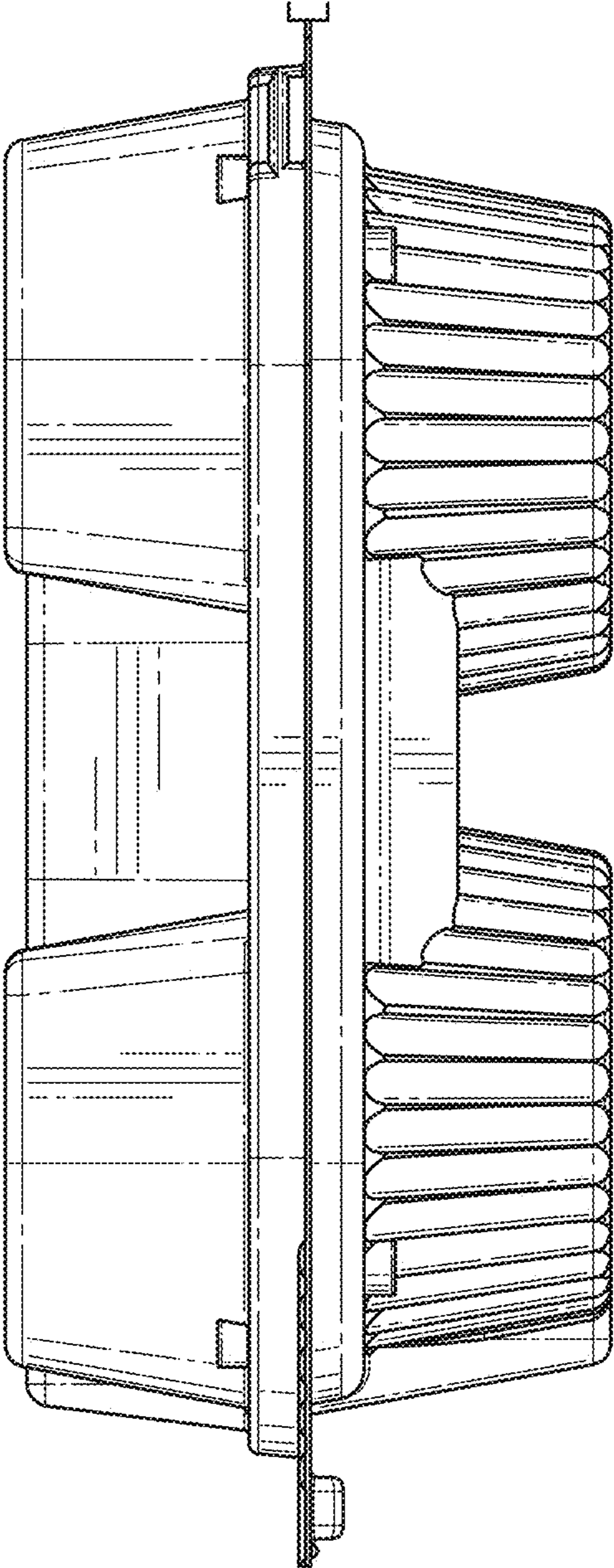

FIG. 4

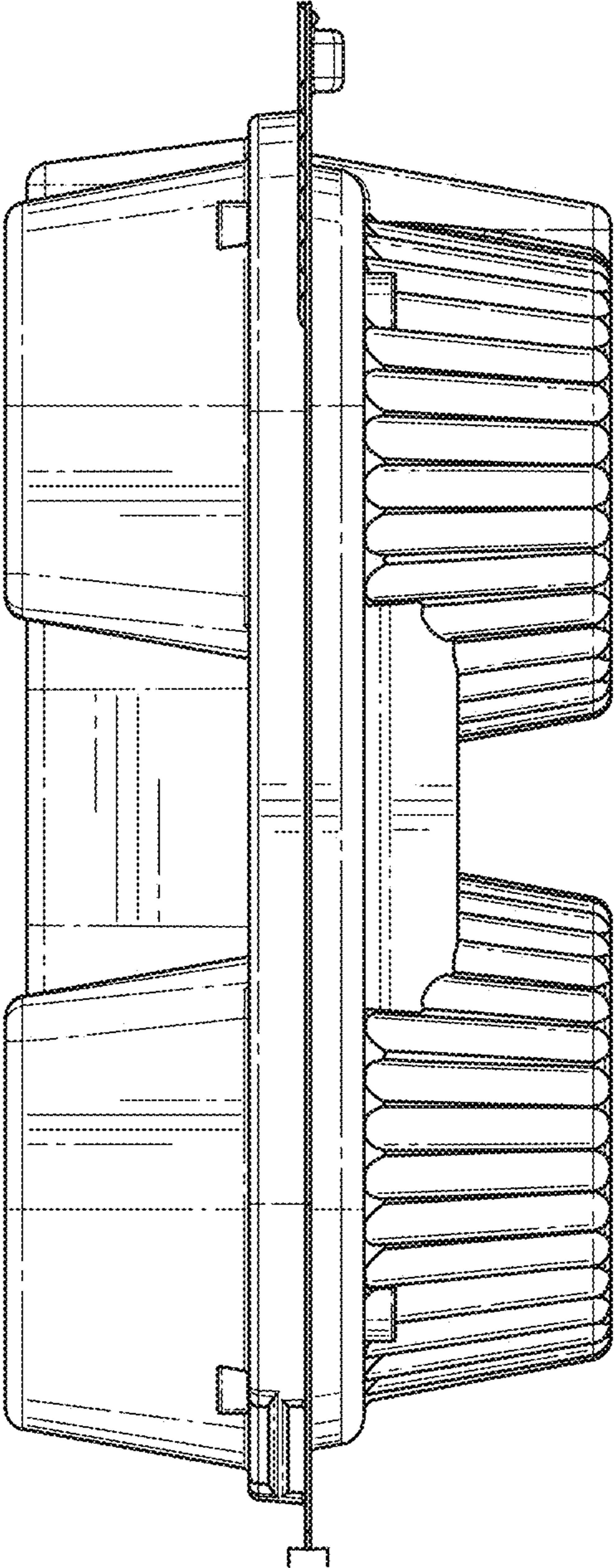

FIG. 5

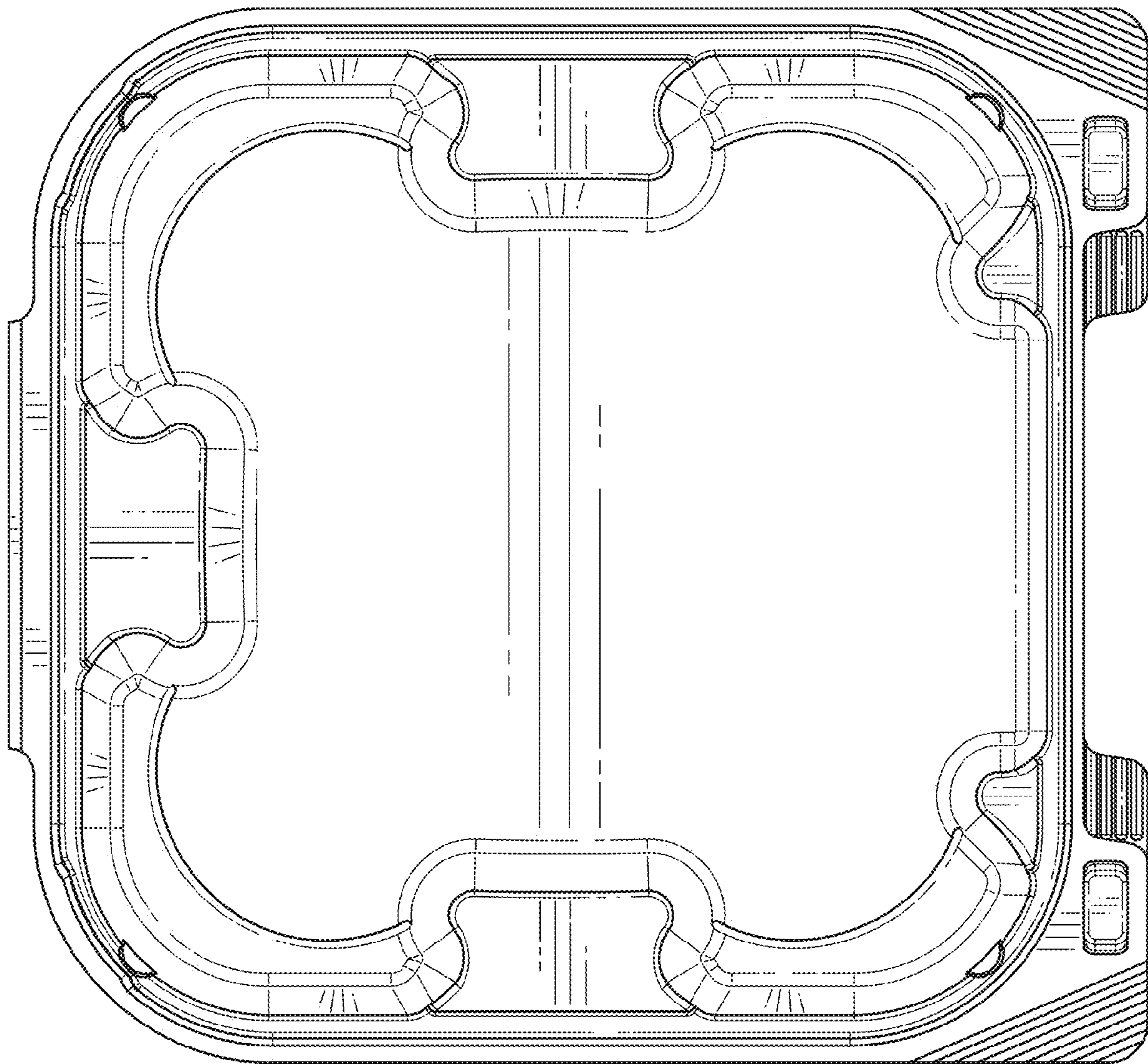

FIG. 6

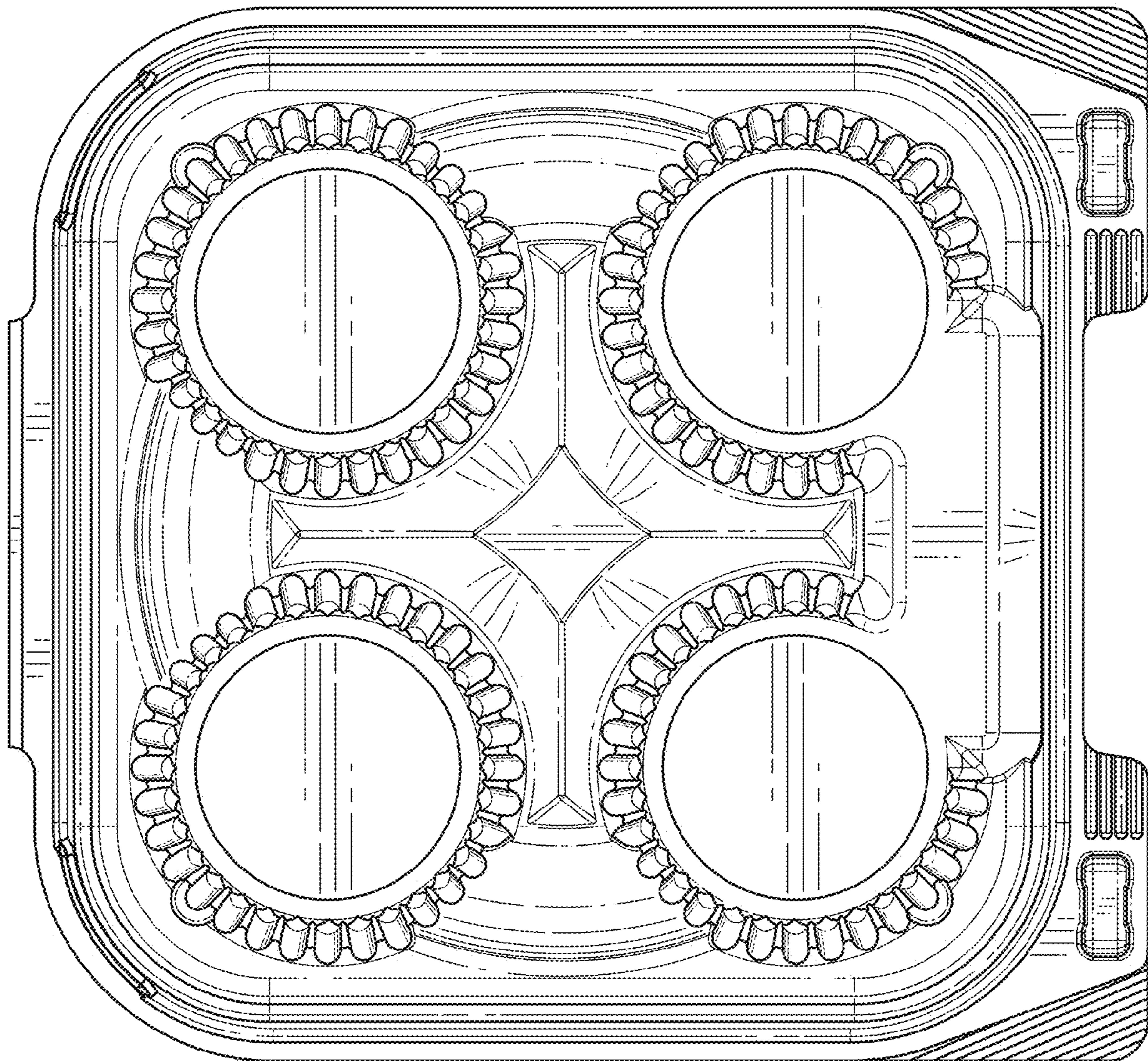

FIG. 7