



US00D880251S

(12) **United States Design Patent** (10) **Patent No.:** **US D880,251 S**  
**Alexander et al.** (45) **Date of Patent:** **\*\* Apr. 7, 2020**

(54) **COOLER**

(71) Applicant: **Ember Technologies, Inc.**, Westlake Village, CA (US)  
(72) Inventors: **Clayton Alexander**, Westlake Village, CA (US); **Daren John Leith**, Agoura Hills, CA (US); **Jacob William Emmert**, Westchester, CA (US); **Mikko Juhani Timperi**, San Marcos, CA (US); **Joseph Lyle Koch**, Anaheim, CA (US)

(73) Assignee: **Ember Technologies, Inc.**, Westlake Village, CA (US)

(\*\*) Term: **15 Years**

(21) Appl. No.: **29/644,813**

(22) Filed: **Apr. 20, 2018**

(51) **LOC (12) Cl.** ..... **07-01**

(52) **U.S. Cl.**  
USPC ..... **D7/605**

(58) **Field of Classification Search**  
USPC ..... D7/603-608, 629, 630; D3/272-274  
CPC .. A45C 11/20; A45C 9/00; A45C 5/14; A45C 5/03; F25D 3/14; F25D 3/08; F25D 3/12; F25D 2400/08; F25D 31/005; B65D 81/3813; B65D 81/3823; B65D 81/3888; B65D 81/3889; B65D 81/3816; B65D 81/3858; F24D 2331/804; A47J 41/022; A47G 19/2288; F25B 19/00

See application file for complete search history.

(56) **References Cited**

U.S. PATENT DOCUMENTS

D272,223 S	1/1984	Oaenen	
D464,485 S *	10/2002	Sward	D3/273
D573,844 S *	7/2008	Hanson	D7/605
D633,342 S	3/2011	Paslawski	
D741,115 S	10/2015	Lane	
D780,521 S *	3/2017	Garcia	D7/605
D782,253 S	3/2017	Boroski	

\* cited by examiner

*Primary Examiner* — Terry A Wallace

(74) *Attorney, Agent, or Firm* — Knobbe, Martens, Olson & Bear LLP

(57) **CLAIM**

The ornamental design for a cooler, as shown and described.

**DESCRIPTION**

FIG. 1 is a top perspective view of a cooler of our new design;  
FIG. 2 is a top view thereof;  
FIG. 3 is a bottom view thereof;  
FIG. 4 is a front view thereof;  
FIG. 5 is a rear view thereof;  
FIG. 6 is a left side view thereof; and,  
FIG. 7 is a right side view thereof.  
Broken lines are used to illustrate border lines of the cooler that form no part of the claimed design.

**1 Claim, 7 Drawing Sheets**

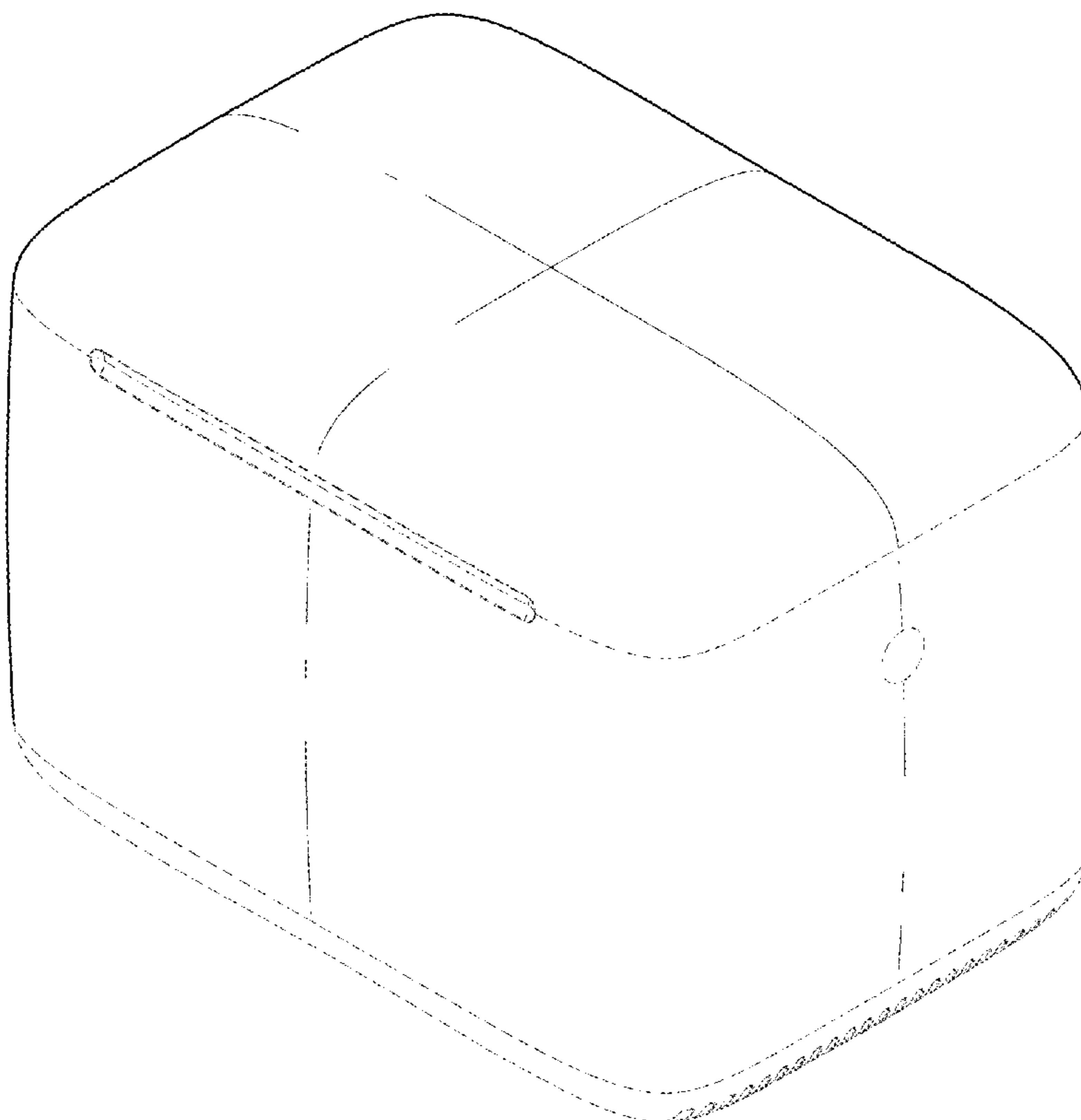

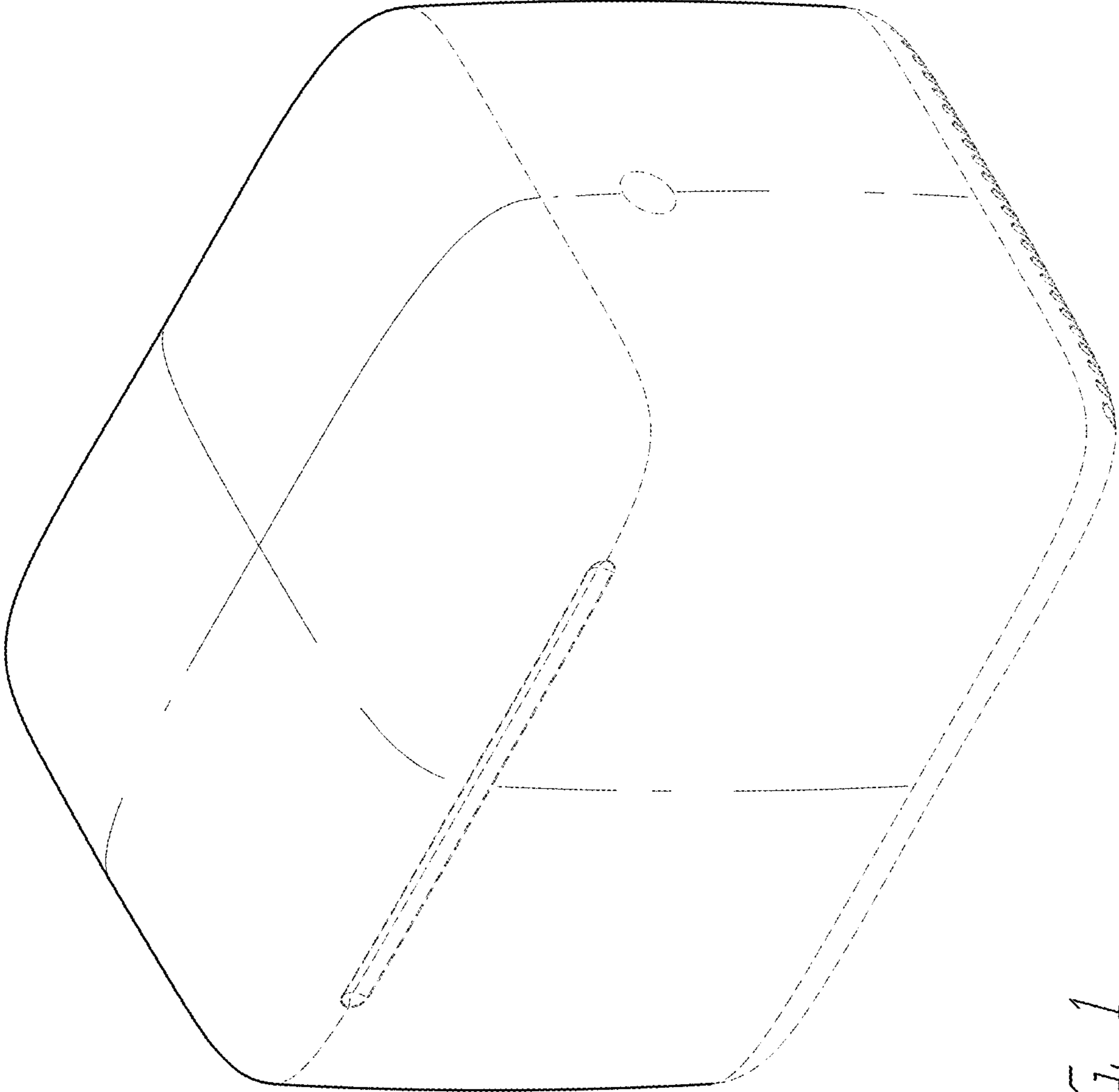

FIG. 1

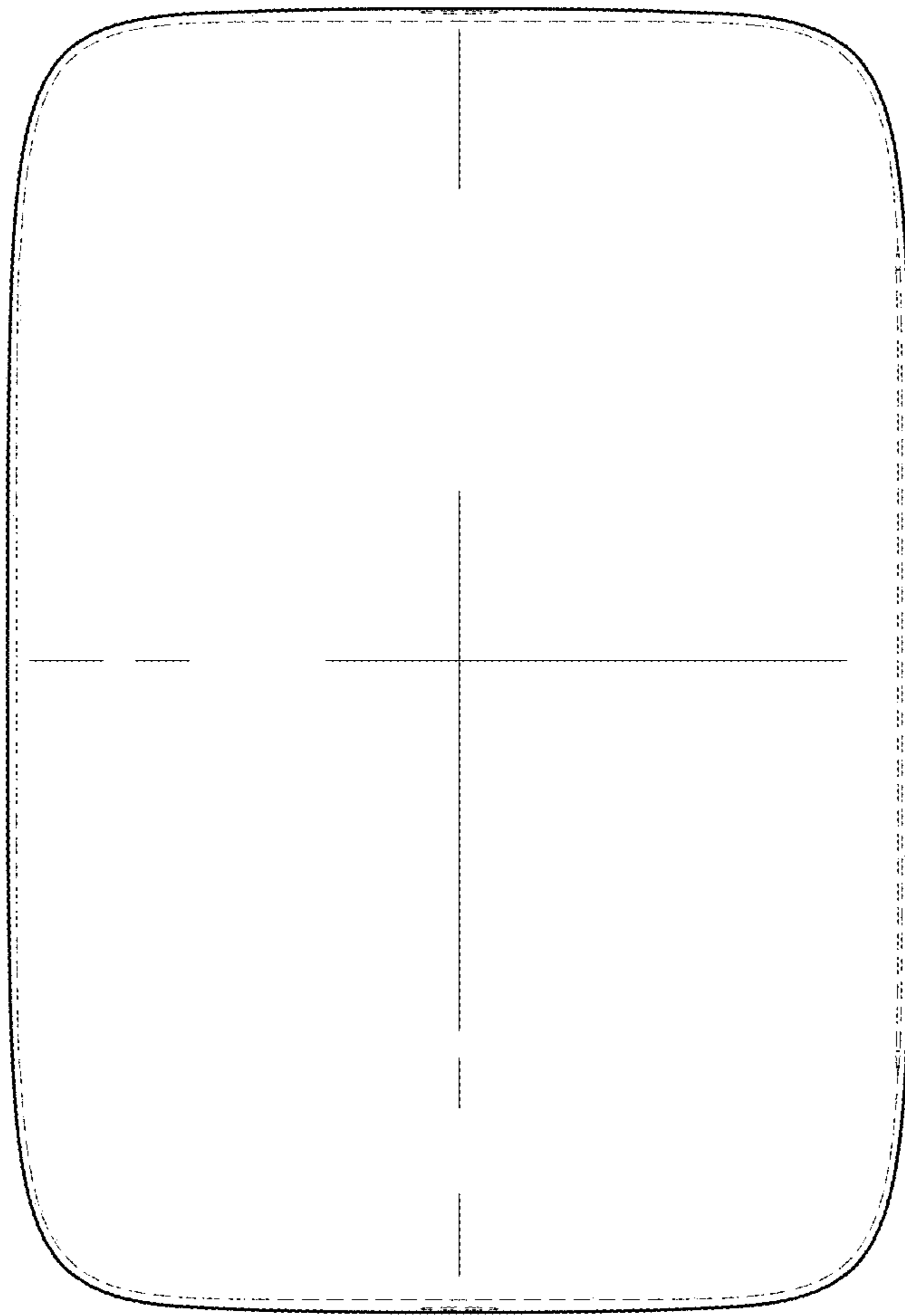

FIG. 2

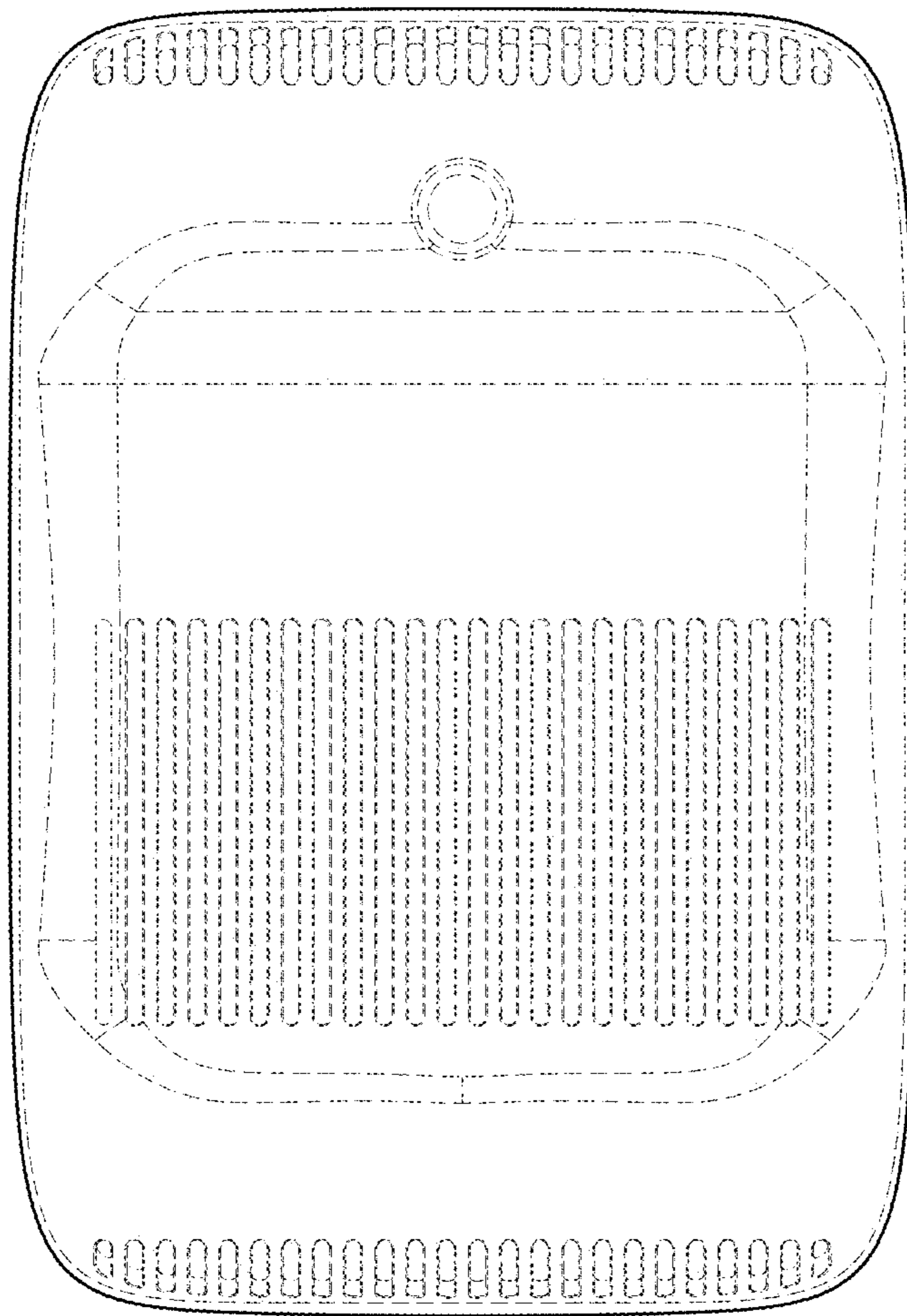

FIG. 3

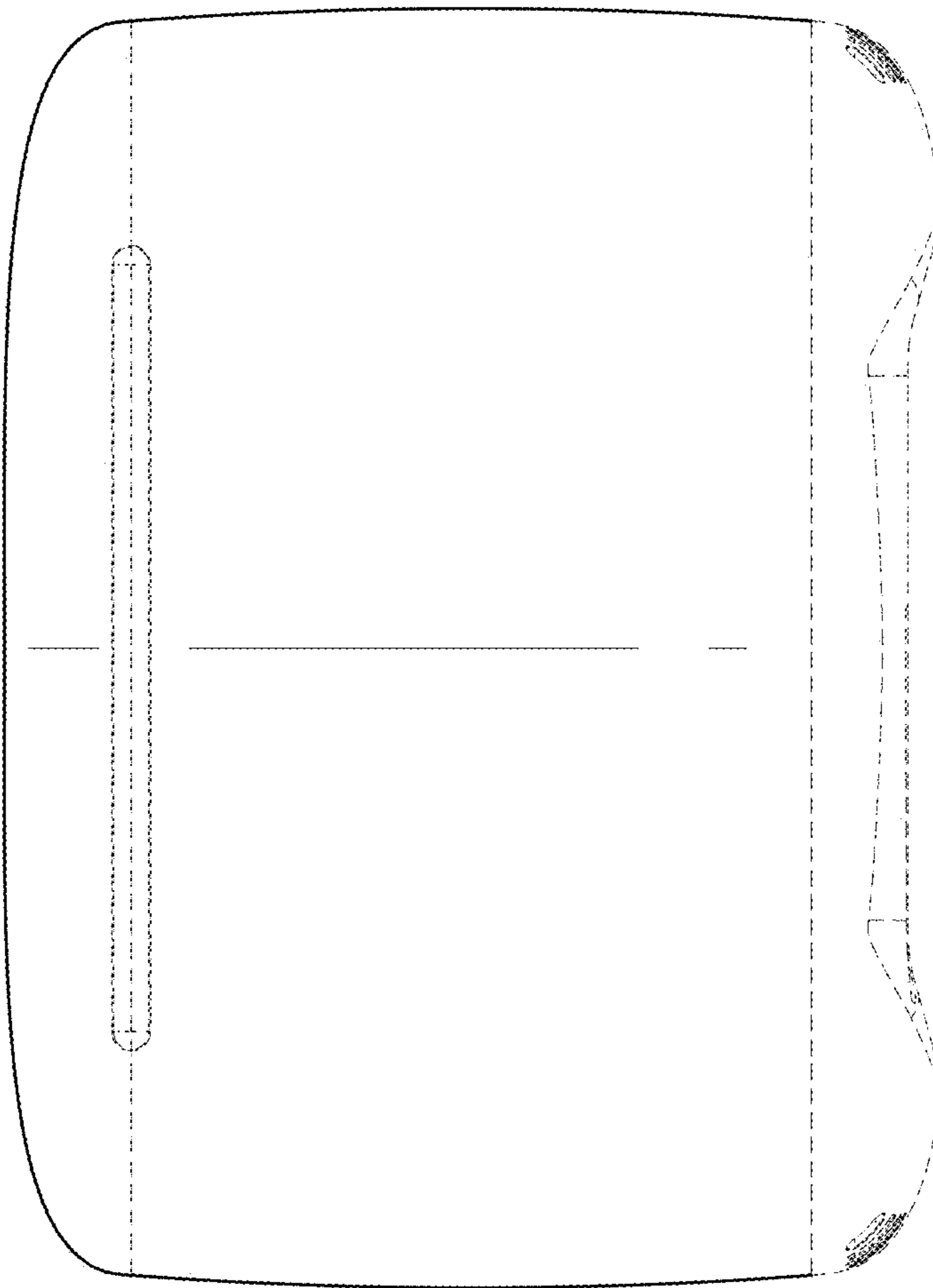

FIG. 4

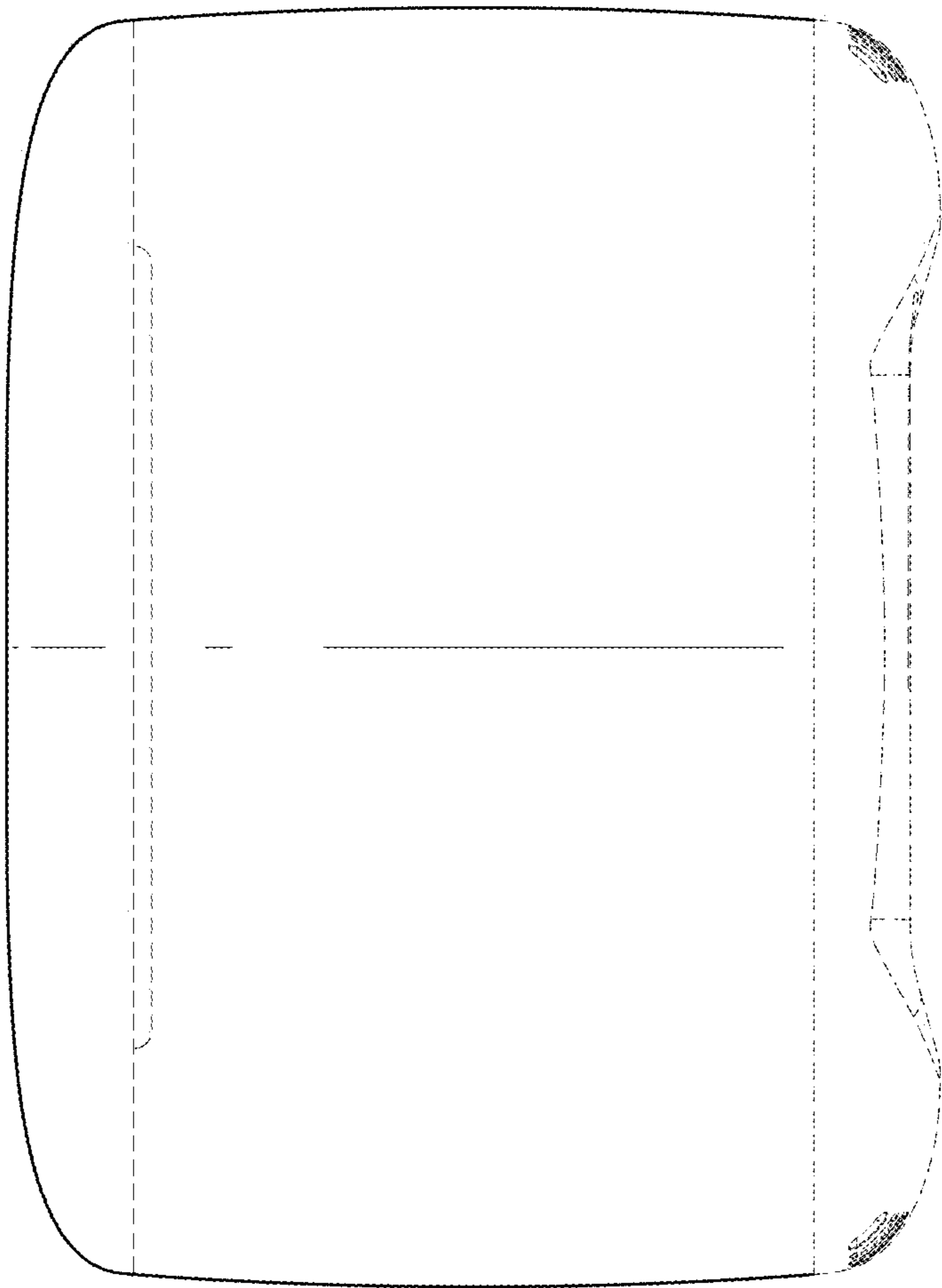

FIG. 5

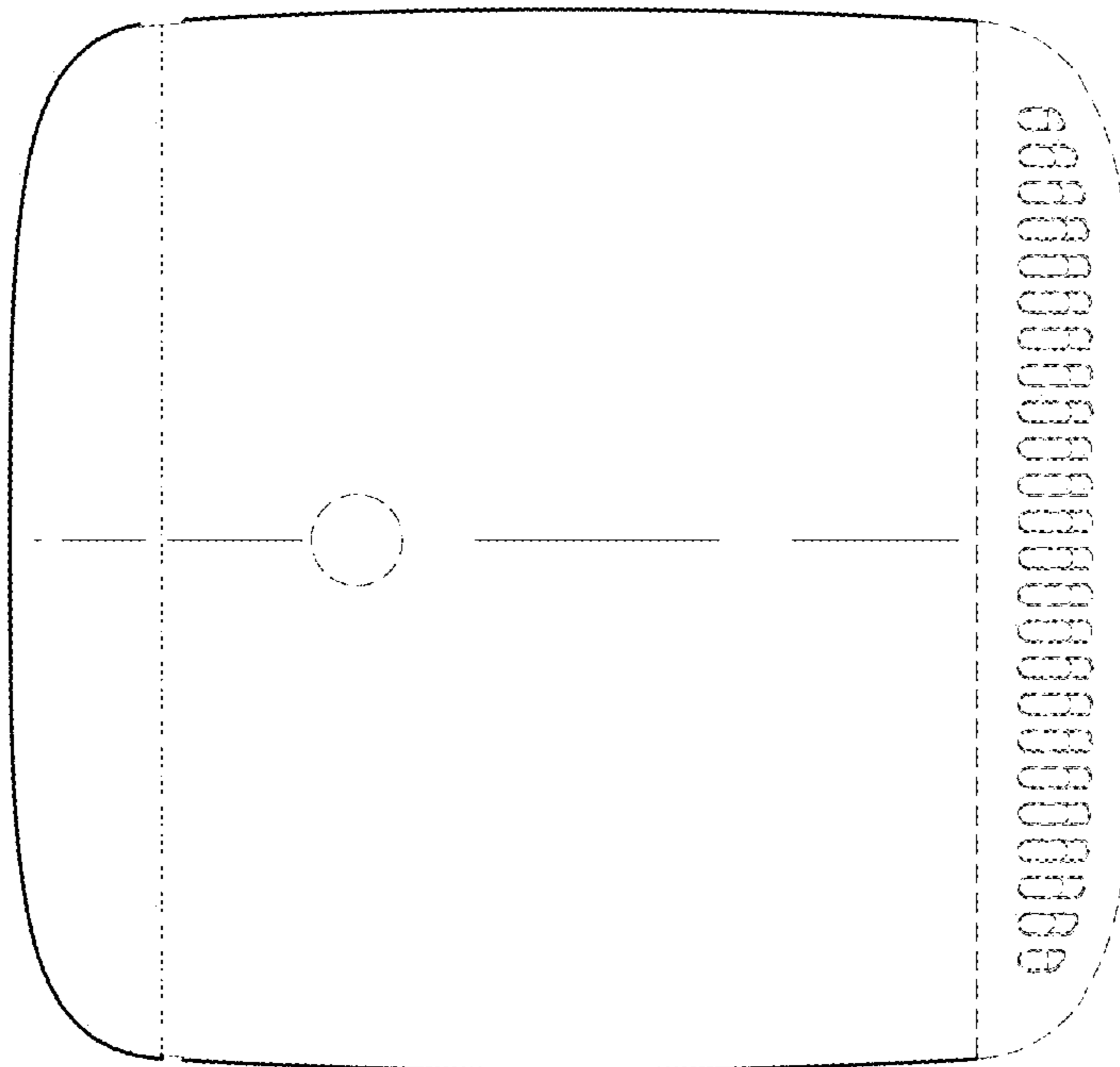

FIG. 6

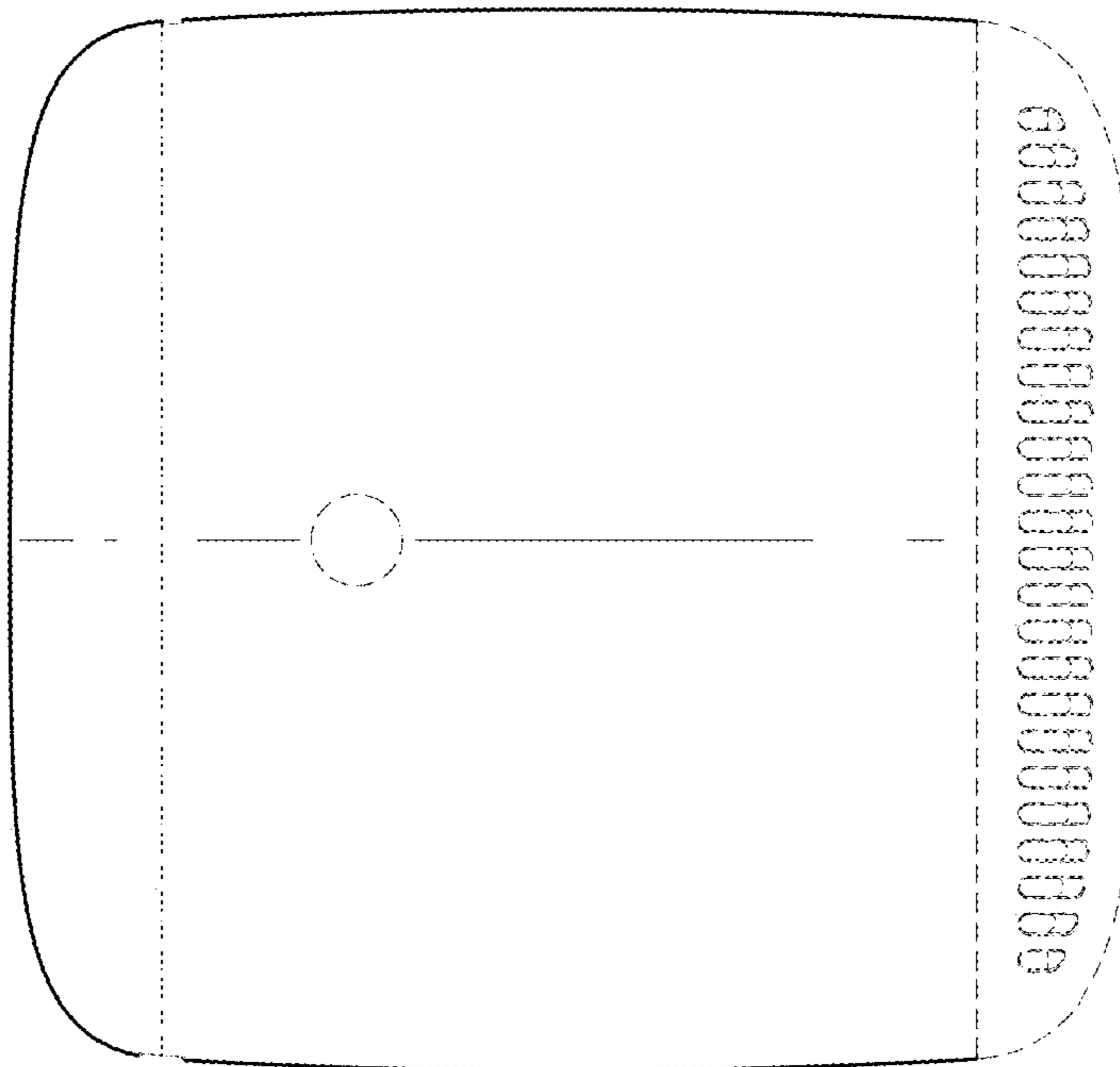

FIG. 7