



US00D880249S

(12) **United States Design Patent** (10) **Patent No.:** **US D880,249 S**  
**Xu** (45) **Date of Patent:** **\*\* Apr. 7, 2020**

- (54) **SILICONE FOOD STORAGE BAG**
- (71) Applicant: **NEWSUN SILICONE PRODUCTS CO., LTD**, Shenzhen (CN)
- (72) Inventor: **Daowang Xu**, Nanping (CN)
- (73) Assignee: **NEWSUN SILICONE PRODUCTS CO., LTD**, Shenzhen (CN)
- (\*\*) Term: **15 Years**
- (21) Appl. No.: **29/675,620**
- (22) Filed: **Jan. 4, 2019**
- (51) **LOC (12) Cl.** ..... **07-07**
- (52) **U.S. Cl.**  
USPC ..... **D7/602**
- (58) **Field of Classification Search**  
USPC ..... D7/601, 602; D9/430; 426/85  
CPC ..... A47G 19/02; A47G 19/025  
See application file for complete search history.

- D580,779 S \* 11/2008 Hartwell ..... D9/705
- 7,503,696 B2 \* 3/2009 Ha ..... B65D 33/007  
24/30.5 R
- D625,613 S \* 10/2010 Cowan-Hughes ..... D9/703
- D668,118 S \* 10/2012 Hayes ..... D7/602
- D672,202 S \* 12/2012 Craft ..... D7/586
- D684,867 S \* 6/2013 English ..... D9/707
- D684,868 S \* 6/2013 Kessler, Jr. .... D9/707
- 8,479,972 B2 \* 7/2013 Craft ..... B65D 5/029  
229/101
- D689,370 S \* 9/2013 Bower ..... D9/707
- D742,246 S \* 11/2015 Tan ..... D9/707
- D755,017 S \* 5/2016 Piechocinski ..... D7/554.2
- D813,684 S \* 3/2018 Williams, Jr. .... D9/703
- D826,063 S \* 8/2018 Kwon ..... D9/643
- D842,122 S \* 3/2019 Song ..... D9/707
- D854,325 S \* 7/2019 Myerson ..... D3/304
- D873,083 S \* 1/2020 Finell ..... D7/602
- D873,084 S \* 1/2020 Finell ..... D7/602

(Continued)

Primary Examiner — Cynthia R Underwood

(57) **CLAIM**

The ornamental design for a silicone food storage bag, as shown and described.

**DESCRIPTION**

FIG. 1 is a perspective view of a silicone food storage bag showing my new design;  
 FIG. 2 is another perspective view thereof;  
 FIG. 3 is a front elevational view thereof;  
 FIG. 4 is a rear elevational view thereof;  
 FIG. 5 is a left side elevational view thereof;  
 FIG. 6 is a right side elevational view thereof;  
 FIG. 7 is a top plan view thereof; and,  
 FIG. 8 is a bottom plan view thereof.  
 The broken lines in the drawings illustrate portions of the silicone food storage bag that form no part of the claimed design.

**1 Claim, 8 Drawing Sheets**

(56) **References Cited**

**U.S. PATENT DOCUMENTS**

- 2,117,738 A \* 5/1938 Metzger ..... B65D 35/00  
383/209
- 3,799,914 A \* 3/1974 Schnnit et al. .... B65D 75/008  
426/85
- D319,780 S \* 9/1991 Laaki ..... D9/707
- 5,499,763 A \* 3/1996 Demars ..... A47G 19/02  
229/114
- 5,758,473 A \* 6/1998 Patelli ..... B65B 9/20  
222/541.6
- 6,245,367 B1 \* 6/2001 Galomb ..... B65D 51/247  
206/541
- D464,258 S \* 10/2002 Edwards ..... D9/708
- D482,614 S \* 11/2003 Countee, Jr. .... D7/705
- D535,568 S \* 1/2007 Hunter ..... D9/703
- D541,171 S \* 4/2007 Delmotte ..... D9/709
- D567,592 S \* 4/2008 Fite, IV ..... D7/566

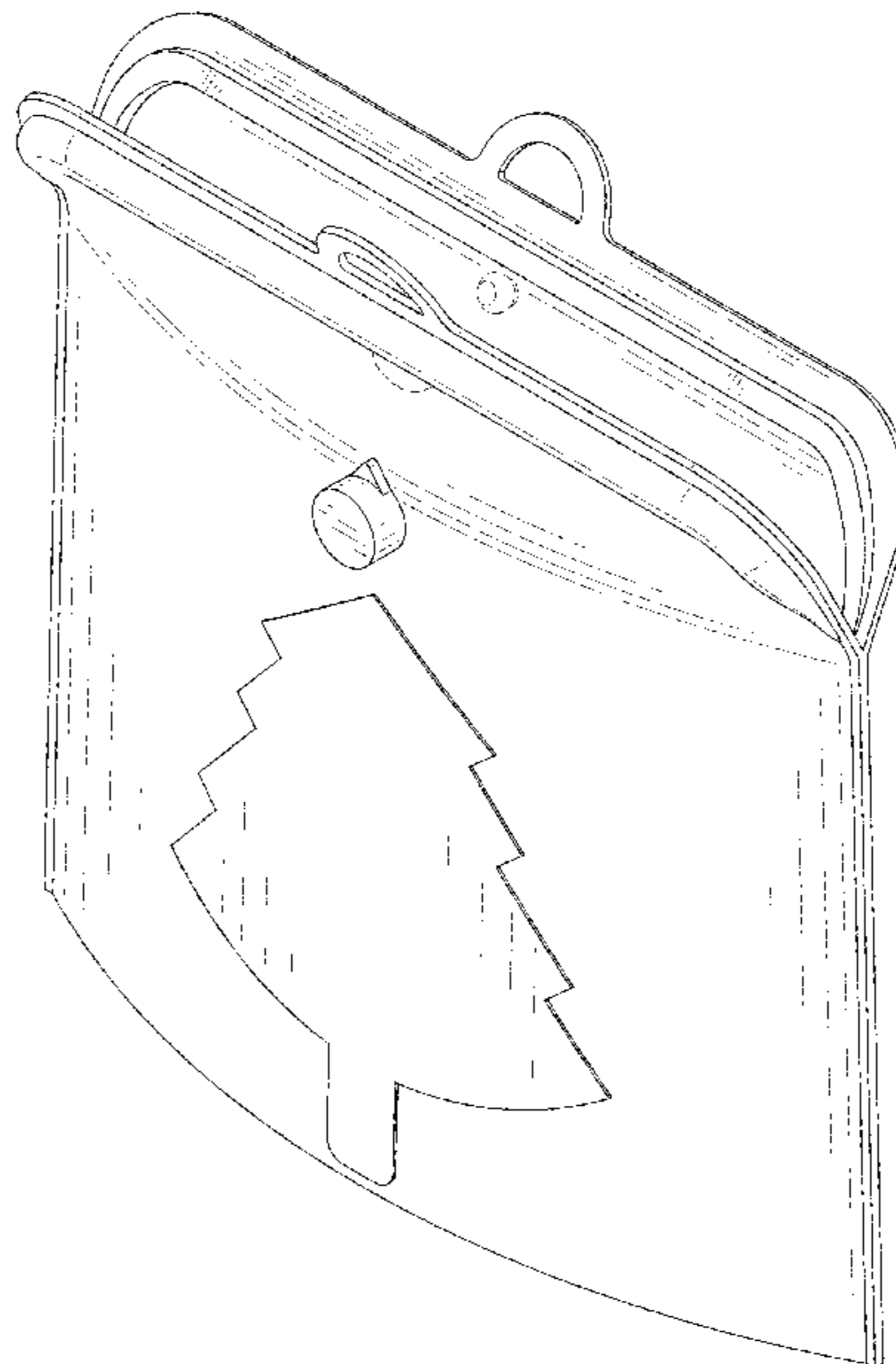

(56)

**References Cited**

U.S. PATENT DOCUMENTS

2003/0066870 A1\* 4/2003 Stewart ..... B65D 3/14  
229/125.09

\* cited by examiner

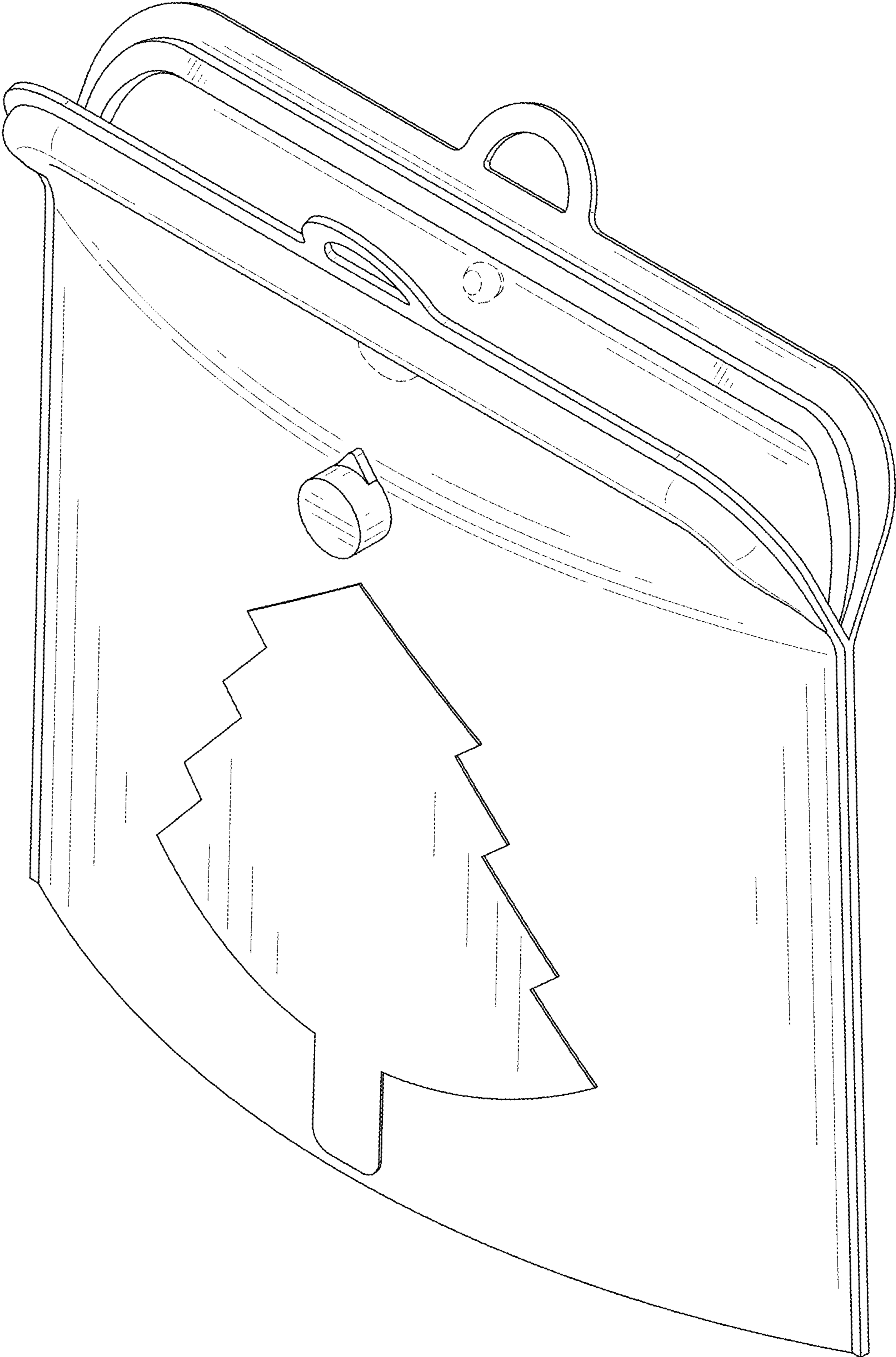

FIG. 1

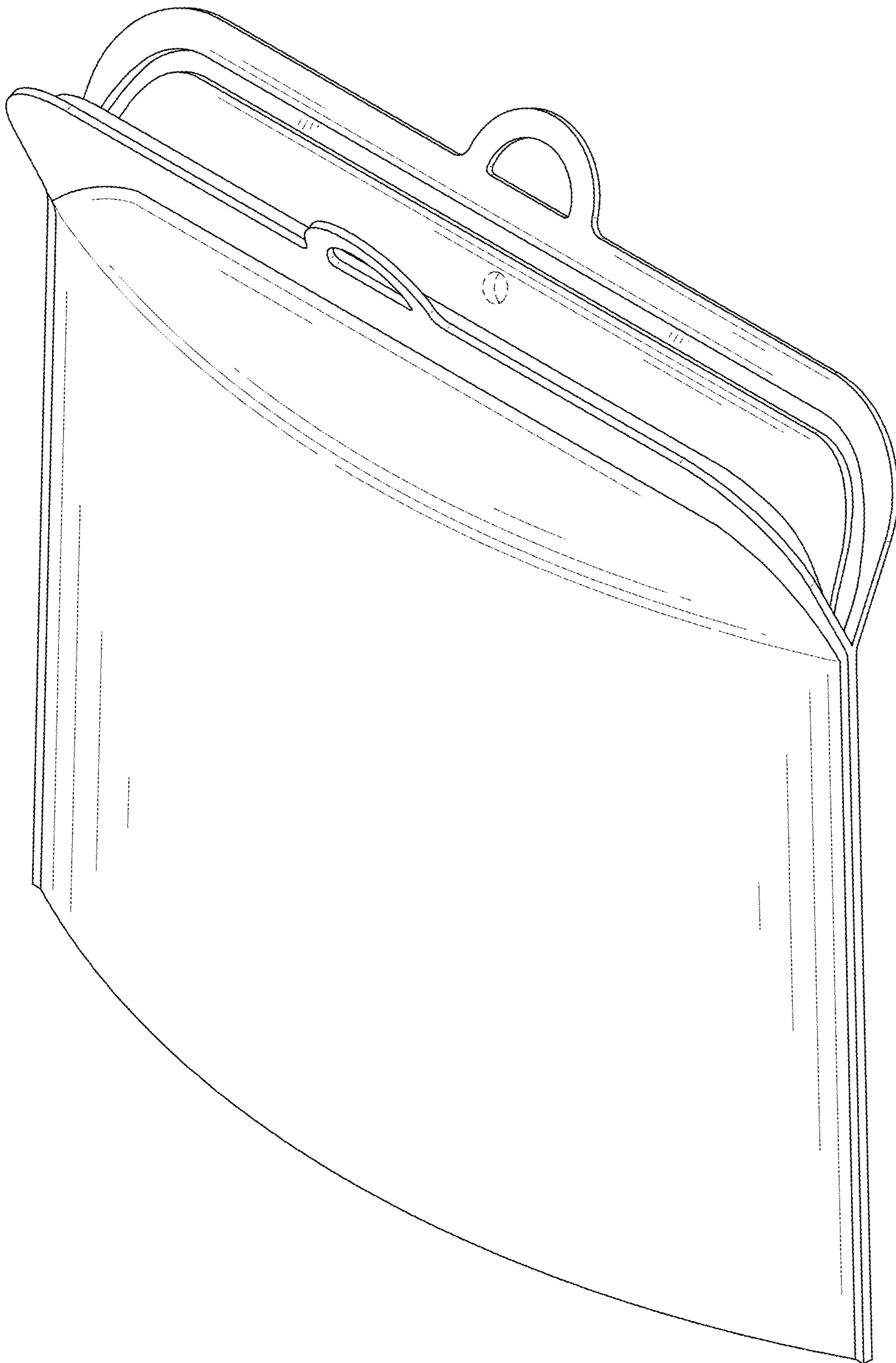

FIG. 2





FIG. 3



FIG. 4

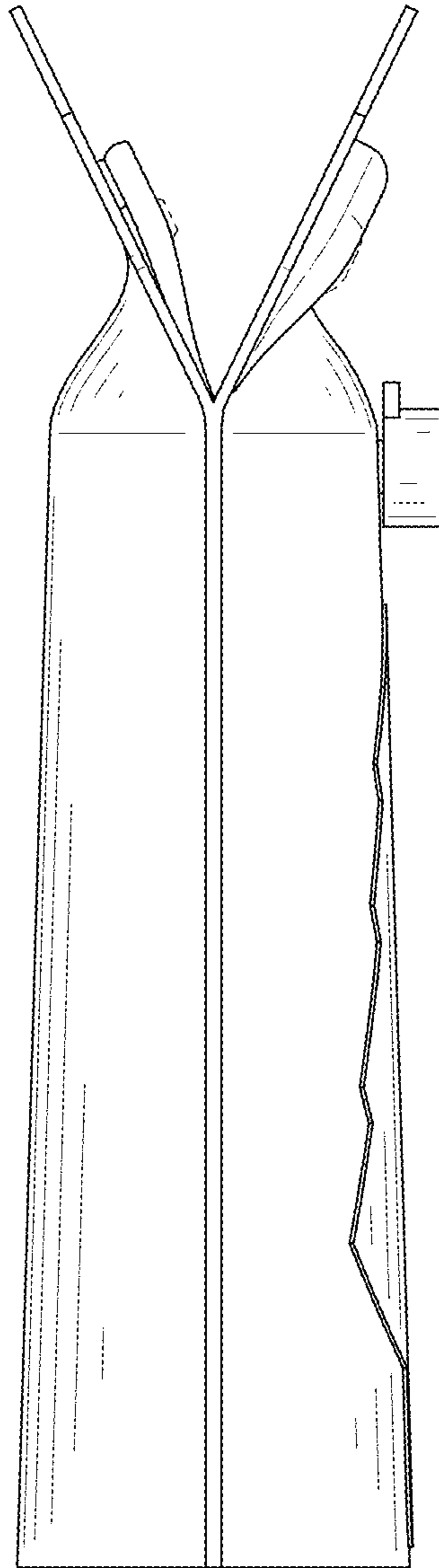

FIG. 5

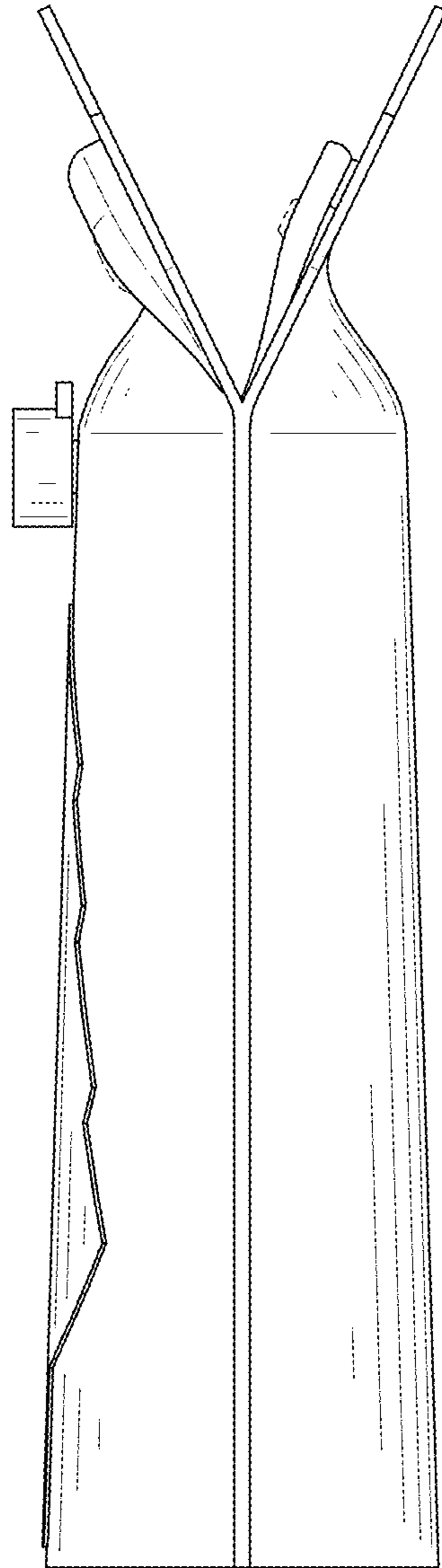

FIG. 6



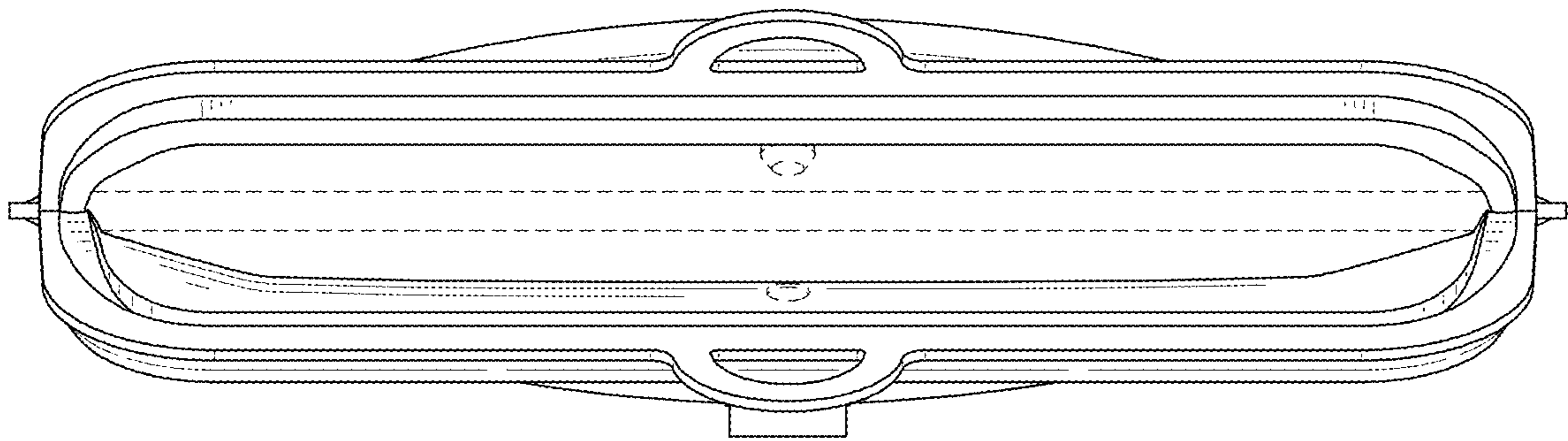

FIG. 7

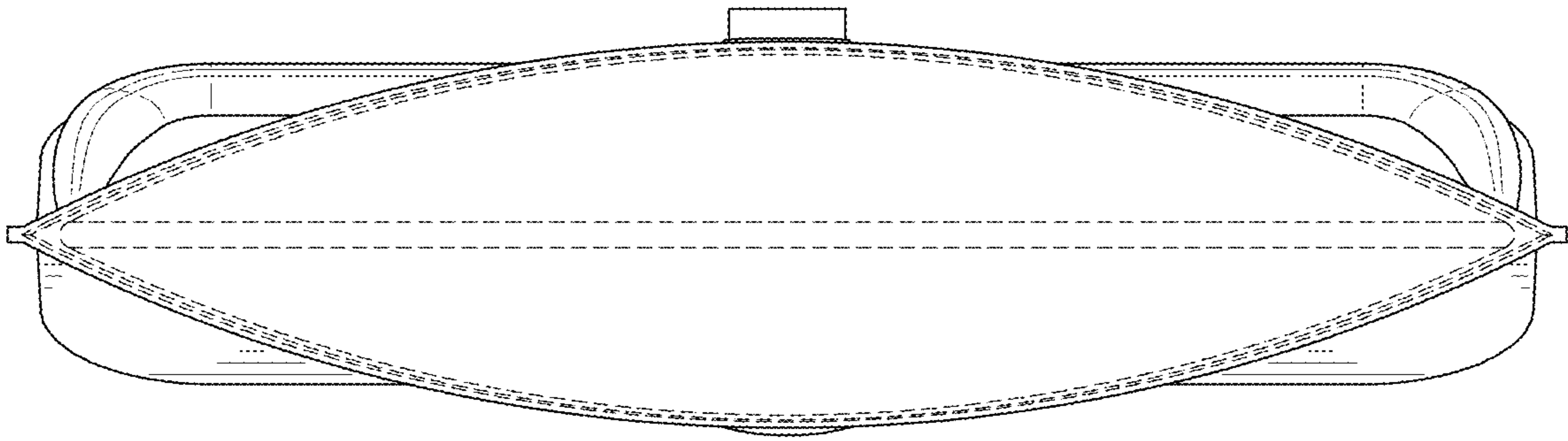

FIG. 8