



US00D880198S

(12) **United States Design Patent**
Umlauf

(10) **Patent No.:** **US D880,198 S**
(45) **Date of Patent:** **** Apr. 7, 2020**

(54) **SPLIT BENCH SEAT COVER**
(71) Applicant: **4Knines, LLC**, Vernon Hills, IL (US)
(72) Inventor: **James Umlauf**, Phoenix, AZ (US)
(**) Term: **15 Years**

10,081,278 B1 * 9/2018 Balzer B60N 2/60
D839,817 S * 2/2019 Erspamer D12/401
D851,963 S * 6/2019 Fischer-Livneh D6/611
2007/0194589 A1 * 8/2007 Aliev B60R 11/00
296/39.1
2009/0091165 A1 * 4/2009 Thompson A47C 31/11
297/228.12

(Continued)

(21) Appl. No.: **29/614,046**
(22) Filed: **Aug. 15, 2017**
(51) **LOC (12) Cl.** **06-13**
(52) **U.S. Cl.**
USPC **D6/611**
(58) **Field of Classification Search**
USPC D6/601-603, 606, 608, 610-612, 617;
D14/239, 450; D12/401, 416, 425
CPC A47C 27/001; A47C 27/002; A47C 31/10;
A47C 31/105; A47C 31/11; A47C 31/113;
A47C 31/116; A47C 4/28; A47C 7/02;
A47C 7/021; A47C 7/022; A47C 7/386;
A47C 7/42; A47C 7/68; B60N 2/60;
B60N 2/58; B60N 2/585; B60N 2/6009
See application file for complete search history.

OTHER PUBLICATIONS

Dog Car Seat Covers by Winner Outfitters. Sold by Amazon.com.
May 28, 2017. Accessed on Jun. 17, 2018.*

(Continued)

Primary Examiner — Kevin K Rudzinski
Assistant Examiner — Clare Ann Gannon
(74) *Attorney, Agent, or Firm* — David R. Conklin;
Kirton McConkie

(57) **CLAIM**

The ornamental design for a split bench seat cover, as shown and described.

DESCRIPTION

FIG. 1 is a front perspective view of a split bench seat cover in accordance with the present design;
FIG. 2 is a front elevation view thereof;
FIG. 3 is a rear elevation view thereof;
FIG. 4 is a left side elevation view thereof;
FIG. 5 is a right side elevation view thereof;
FIG. 6 is a top plan view thereof; and,
FIG. 7 is a bottom plan view thereof.
The broken lines shown in the drawings forming a cross-hatch pattern depict an environment that forms no part of the claim. The broken lines shown in FIG. 3 forming ten rectangles depict environments that form no part of the claim. The remaining broken lines in the drawings illustrate claimed stitching.

(56) **References Cited**
U.S. PATENT DOCUMENTS
D251,341 S * 3/1979 Bodrero D6/611
D377,423 S * 1/1997 Latrella D6/333
D477,717 S * 7/2003 Gillenwater D6/333
6,676,209 B1 * 1/2004 Szabo B60N 2/60
297/188.01
7,261,375 B2 * 8/2007 Godshaw A01K 1/0272
119/28.5
D636,211 S * 4/2011 Kolander B60N 2/6018
D6/601
D674,648 S * 1/2013 Galinski B60N 2/60
D6/611
9,669,742 B1 * 6/2017 Bailey B60N 2/5816
D796,870 S * 9/2017 Hoffman B60N 2/60
D6/611
9,845,033 B1 * 12/2017 Umlauf B60N 2/6018

1 Claim, 5 Drawing Sheets

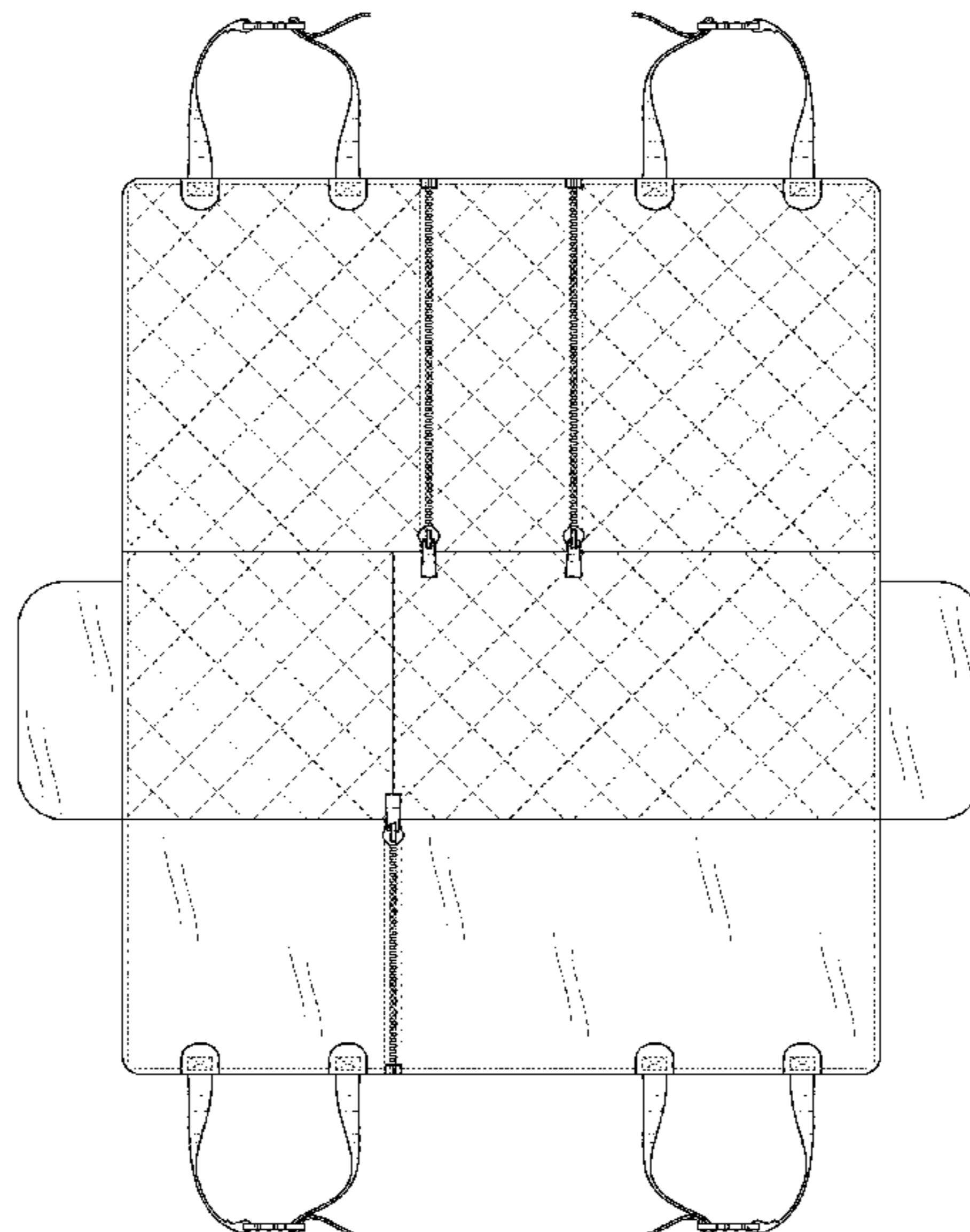

(56)

References Cited

U.S. PATENT DOCUMENTS

2016/0318430 A1* 11/2016 Umlauf B60N 2/90
2018/0251054 A1* 9/2018 Umlauf B60N 2/60

OTHER PUBLICATIONS

Dog Seat Cover with Hammock by 4Knines. Sold by Amazon.com.
Jul. 17, 2014. Accessed on Aug. 31, 2019.*
Dog Seat Cover with Hammock for Fold Down Rear Bench Seat by
4Knines. Sold by Amazon.com. Nov. 4, 2015. Accessed on Aug. 31,
2019.*

* cited by examiner

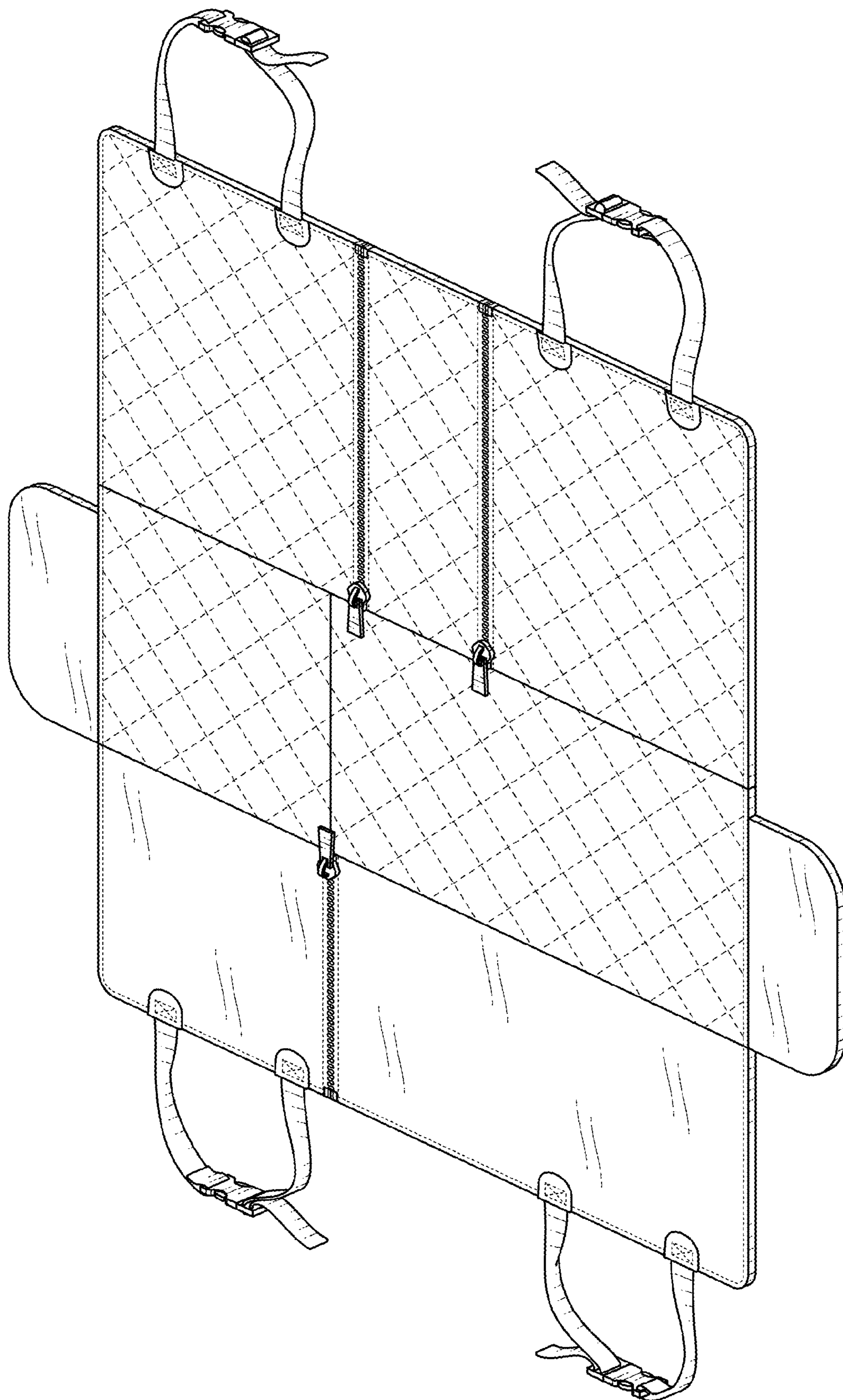

FIG. 1

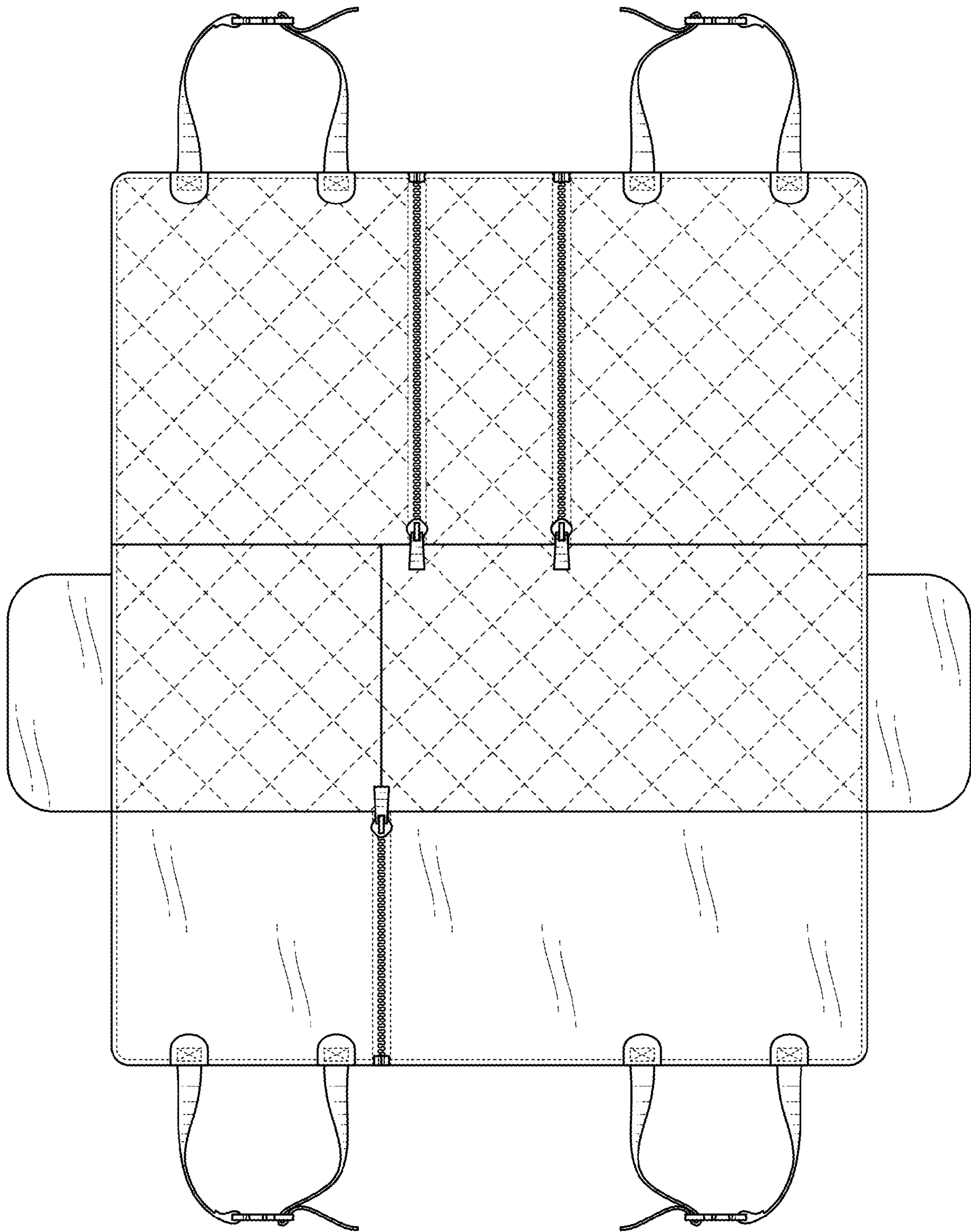

FIG. 2

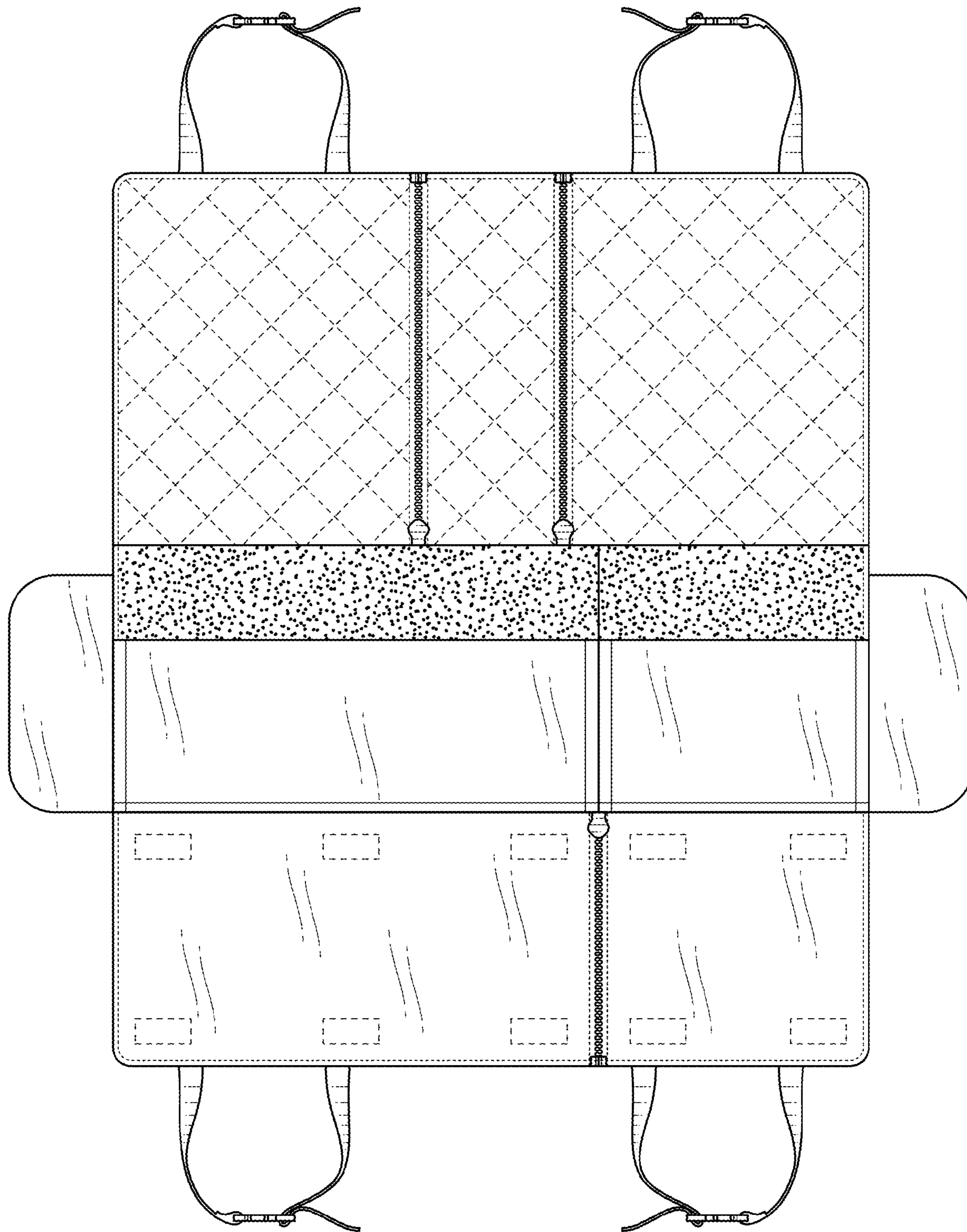

FIG. 3

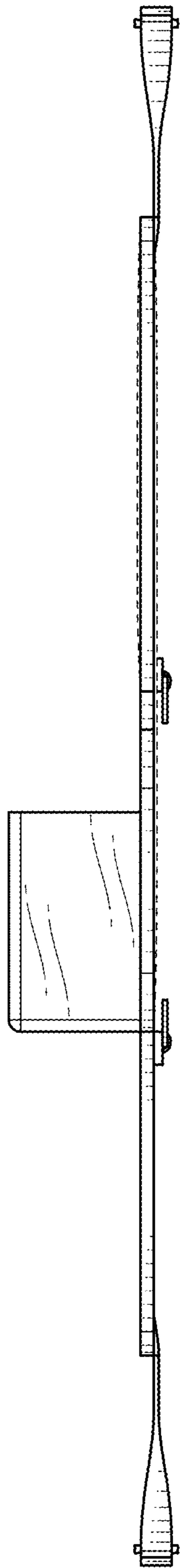

FIG. 4

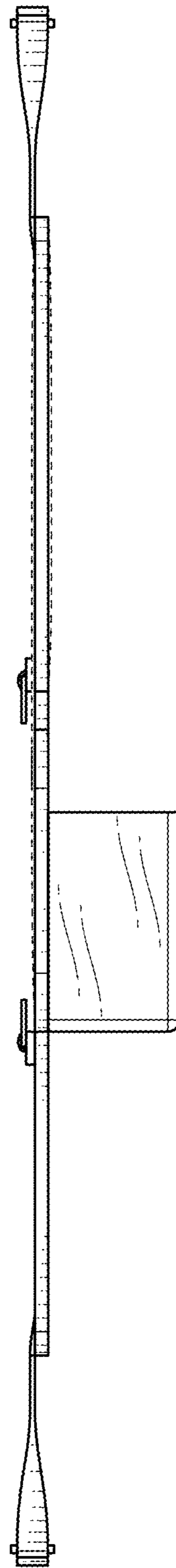

FIG. 5

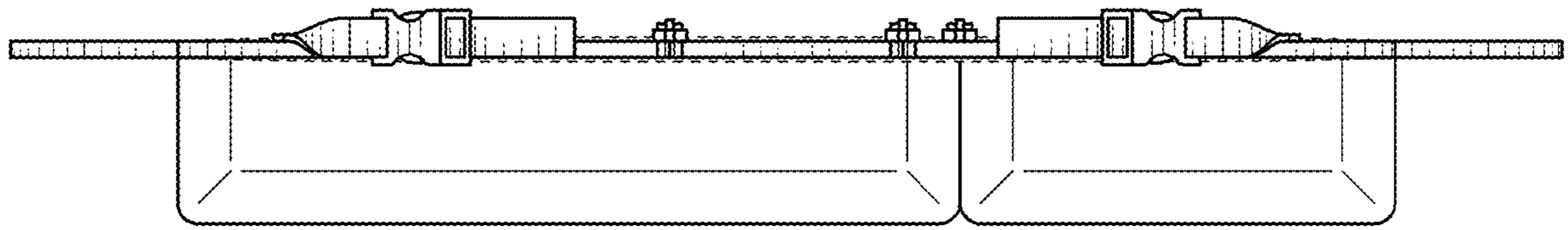

FIG. 6

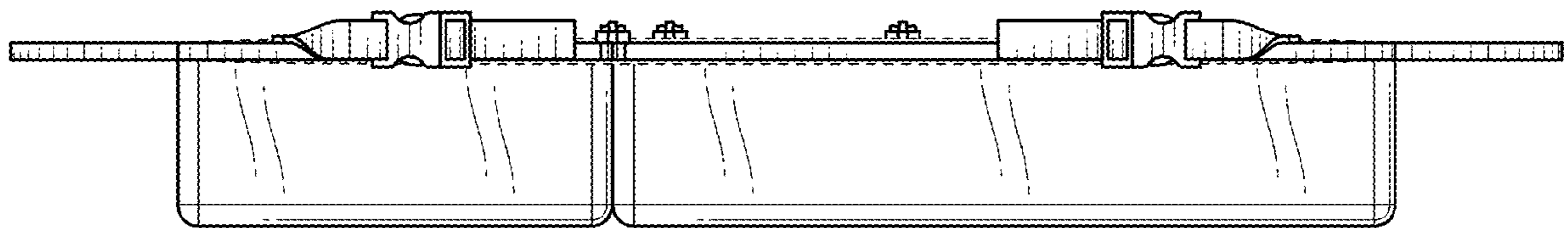

FIG. 7