



(12) **United States Design Patent** (10) **Patent No.:** **US D880,191 S**
Lai (45) **Date of Patent:** **** Apr. 7, 2020**

(54) **WALL MOUNTED JEWELRY SHELF WITH HOOKS**

Primary Examiner — Wan Laymon

Assistant Examiner — Mark Booker

(71) Applicant: **MyGift Enterprise, LLC**, Woodinville, WA (US)

(74) *Attorney, Agent, or Firm* — Dean A. Craine; Marisa C. Whitaker

(72) Inventor: **Sin Lai**, Woodinville, WA (US)

(**) Term: **15 Years**

(57) **CLAIM**

(21) Appl. No.: **29/667,262**

The ornamental design for a wall mounted jewelry shelf with hooks, as shown and described.

(22) Filed: **Oct. 19, 2018**

(51) **LOC (12) Cl.** **06-04**

(52) **U.S. Cl.**
 USPC **D6/571**

(58) **Field of Classification Search**

DESCRIPTION

USPC D6/571, 672, 673, 675, 675.1, 705, 512, D6/524, 552, 553, 572, 573, 574, 569; D8/345, 363, 367, 371–373, 380; 206/349; 211/13.1, 85.9, 86.01, 87.01
 CPC A47B 81/00; A47B 47/04; A47B 57/65; A47B 97/00; A47B 81/06; A47B 96/00; A47B 96/021; A47B 47/0075; A47B 57/00

FIG. 1 is a front, top perspective view of a wall mounted jewelry shelf with hooks showing my new design.
 FIG. 2 is a front elevational view thereof.
 FIG. 3 is a rear elevation view thereof.
 FIG. 4 is a top plan view thereof.
 FIG. 5 is a bottom plan view thereof.
 FIG. 6 is a left side elevation view thereof.
 FIG. 7 is a right side elevation view thereof; and,
 FIG. 8 is a an enlarged, top perspective view of the right corner of the invention.

See application file for complete search history.

(56) **References Cited**

U.S. PATENT DOCUMENTS

D553,409 S * 10/2007 Rosario D6/571
 D602,294 S * 10/2009 Ferguson D6/569
 D602,295 S * 10/2009 Ferguson D6/572

* cited by examiner

1 Claim, 8 Drawing Sheets

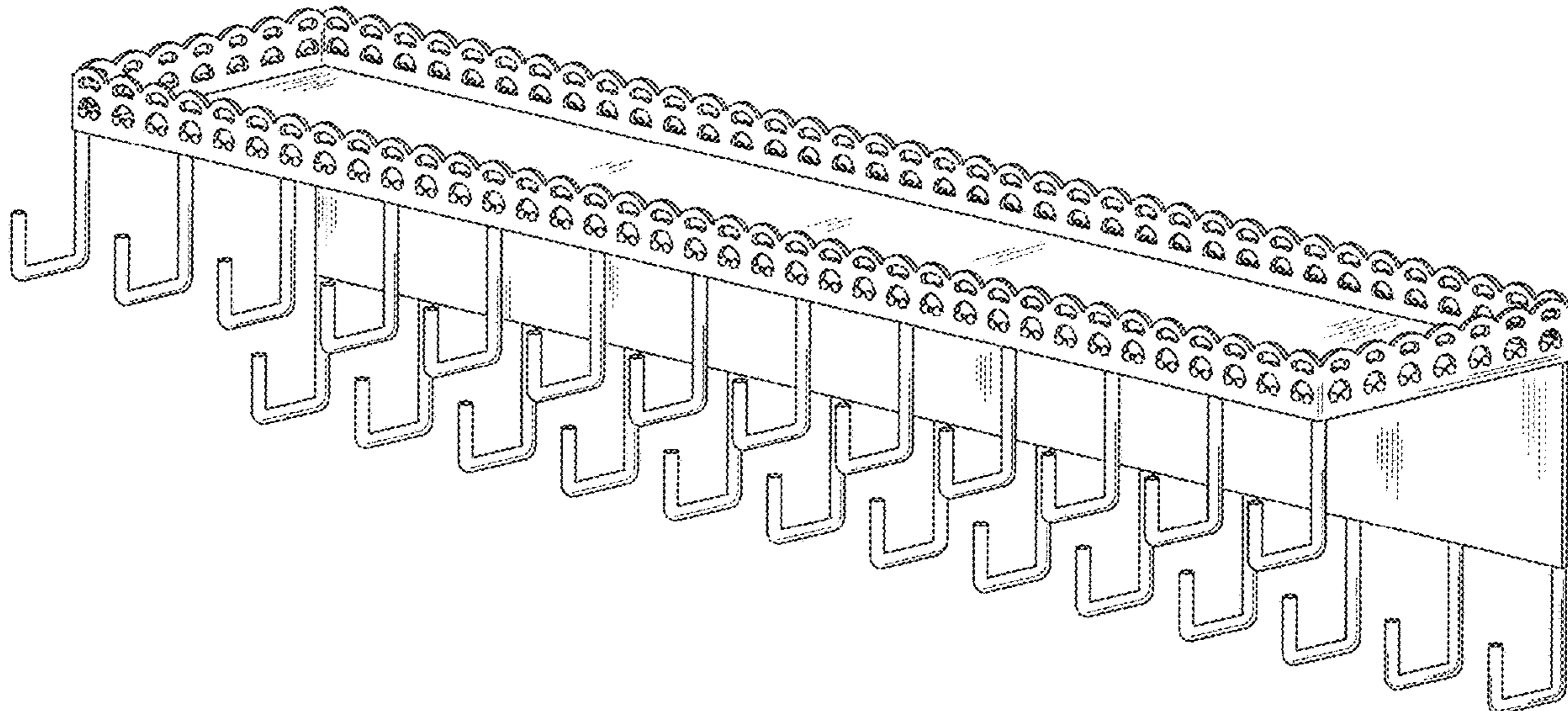

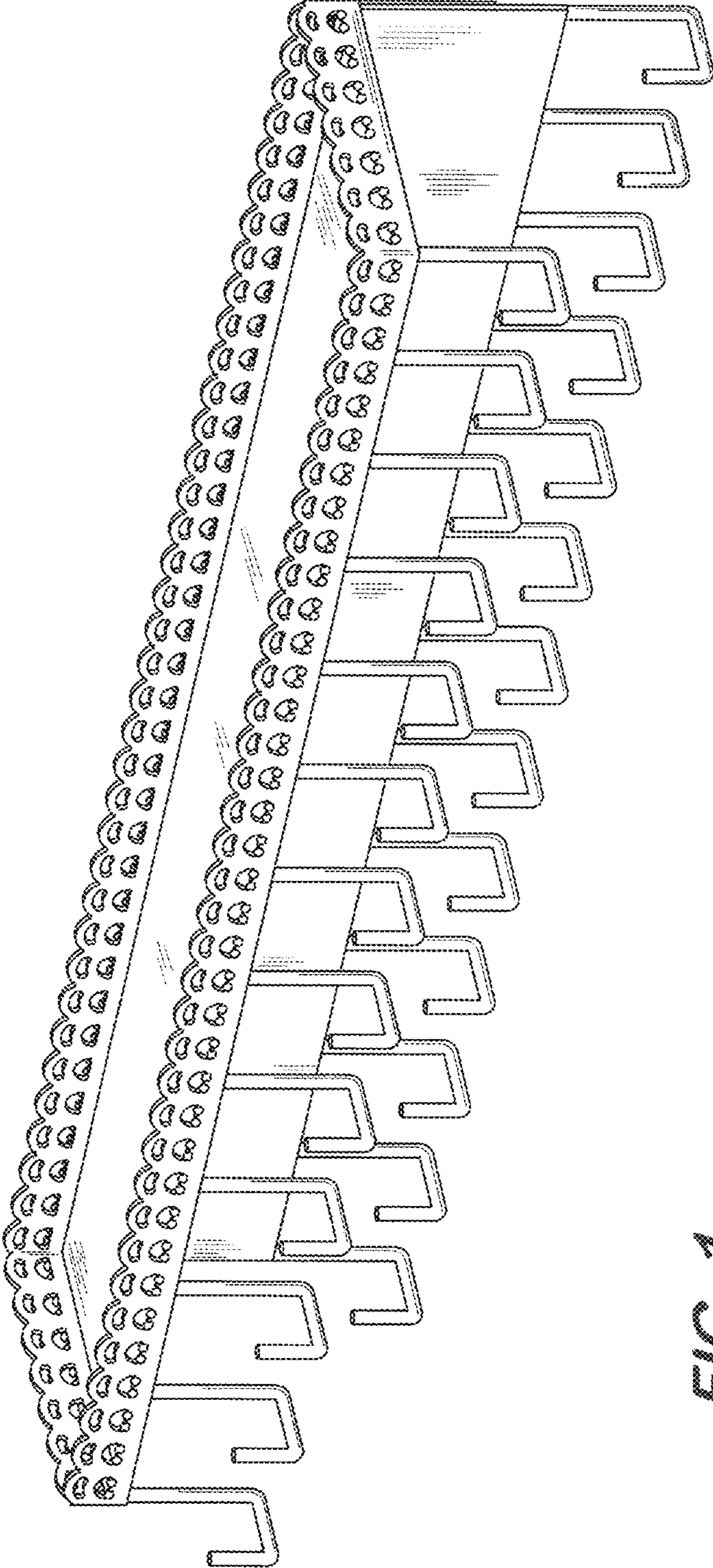

FIG. 1

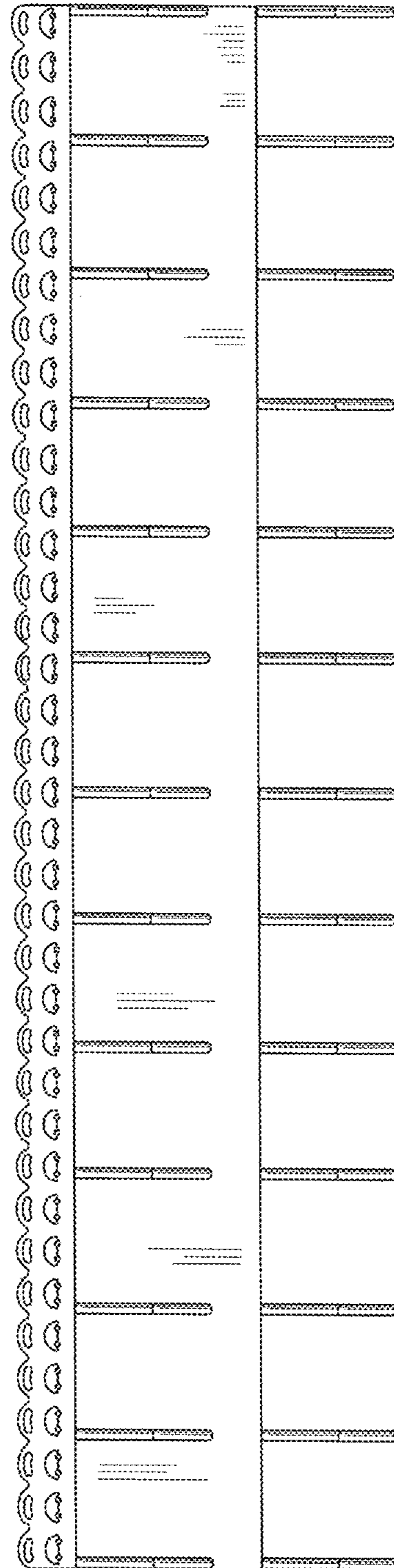

FIG. 2

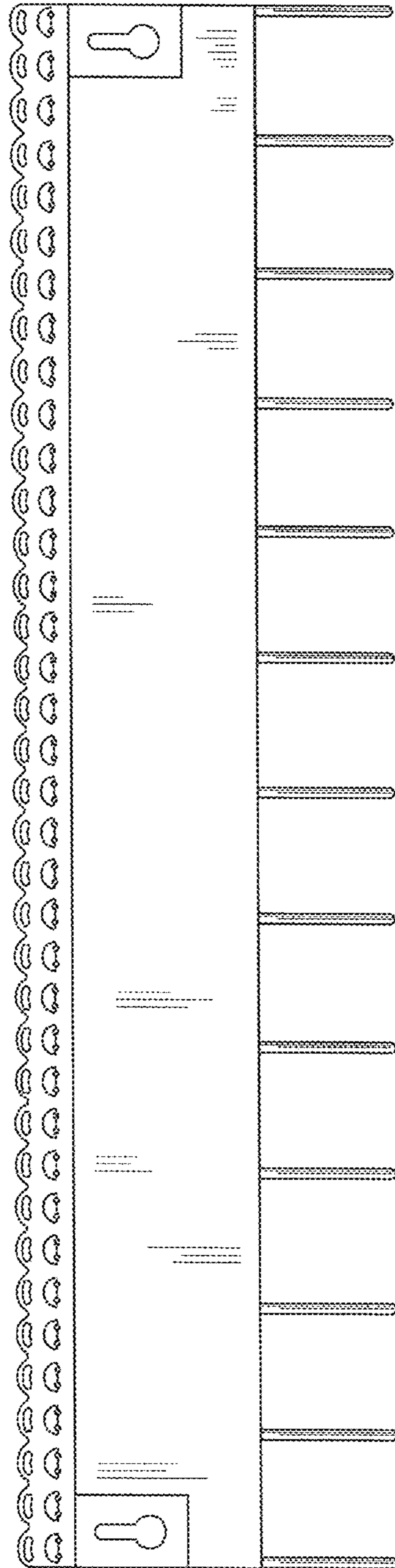

FIG. 3

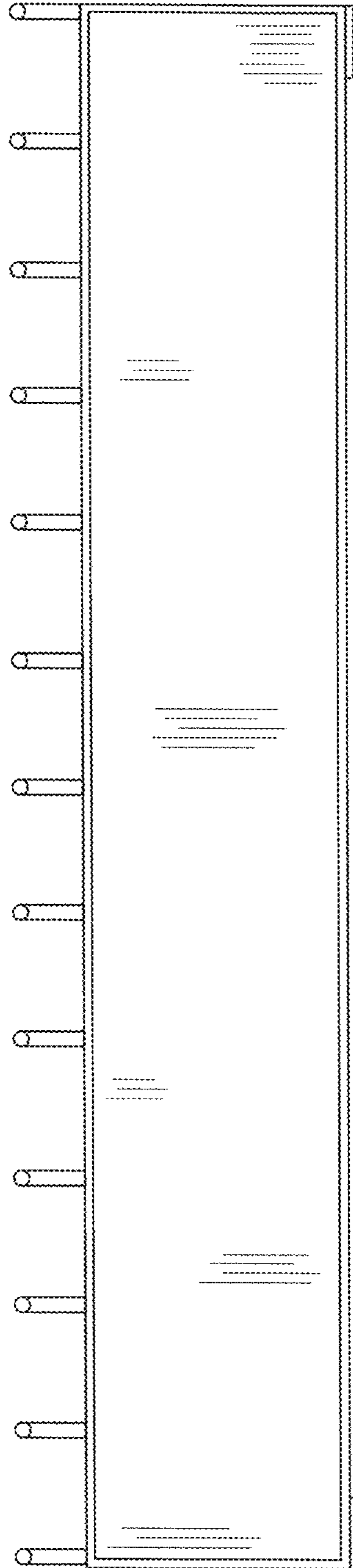

FIG. 4

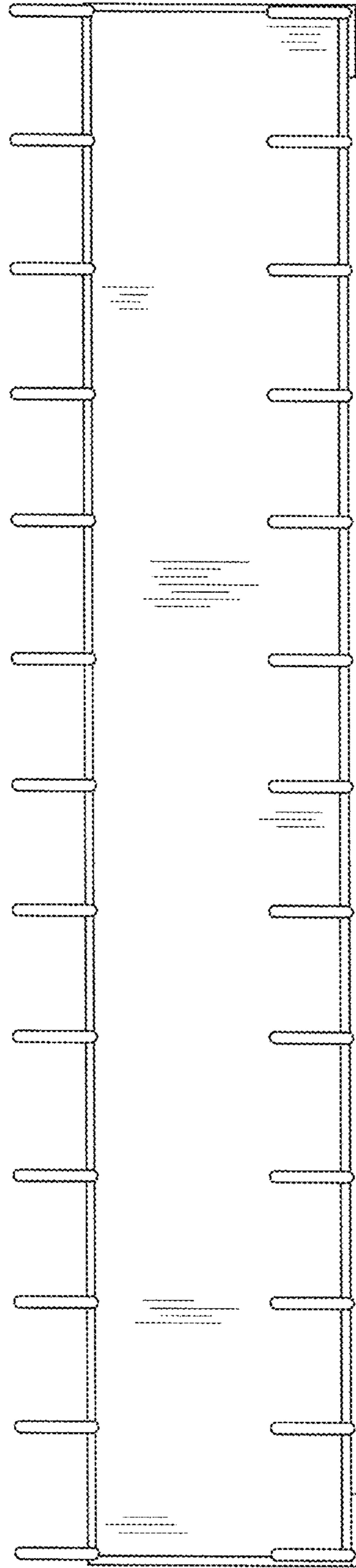

FIG. 5

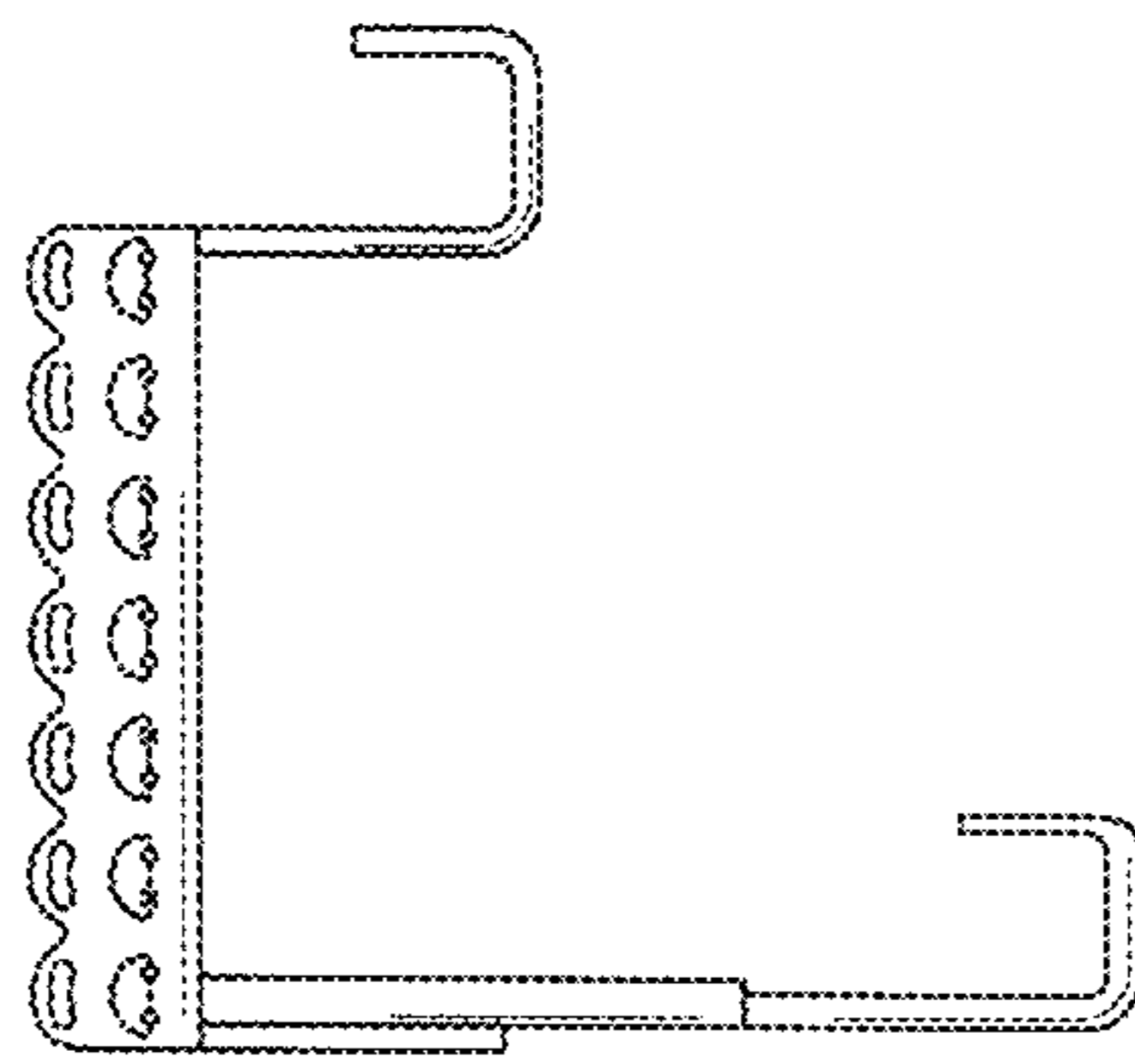

FIG. 6

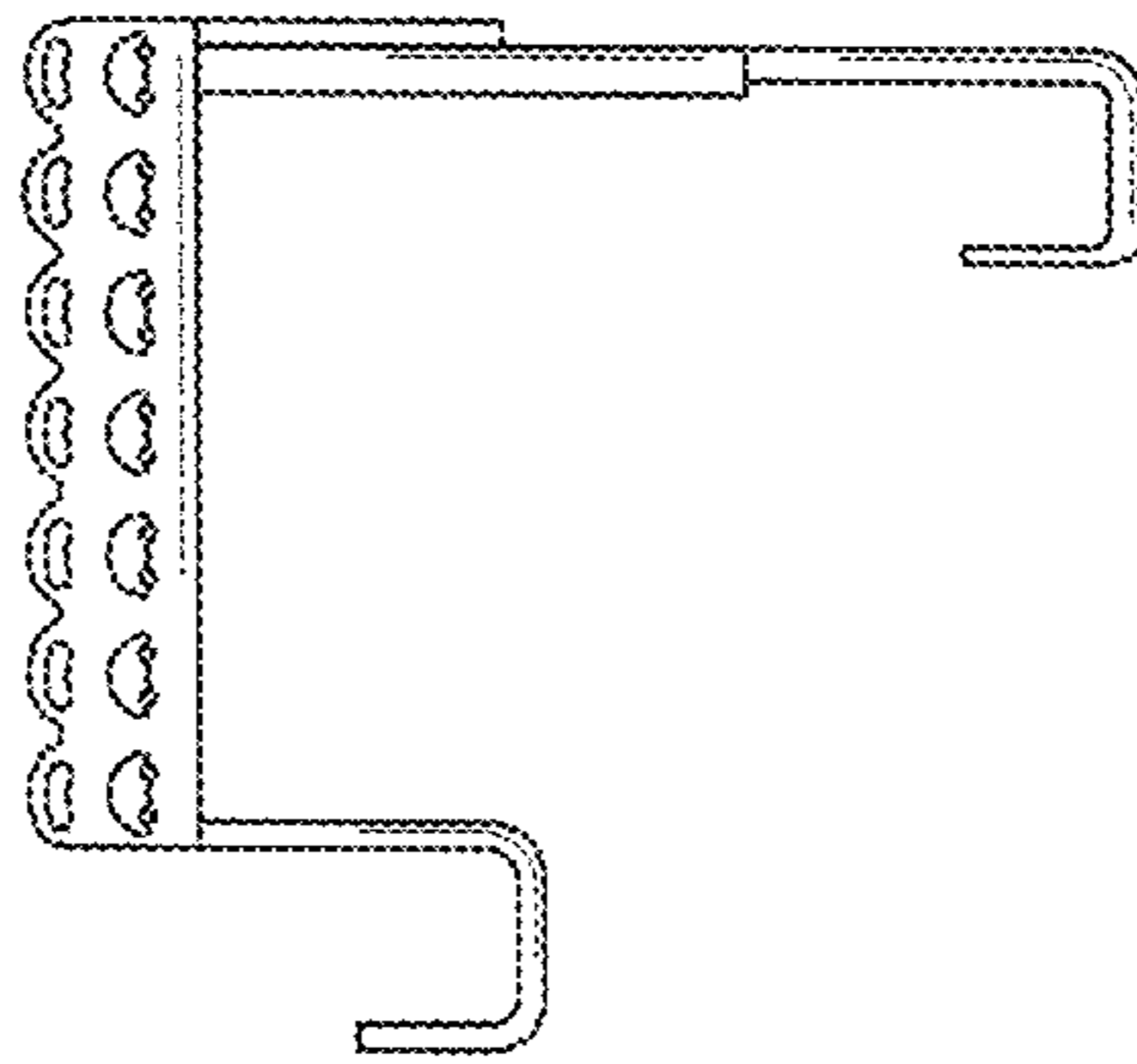

FIG. 7

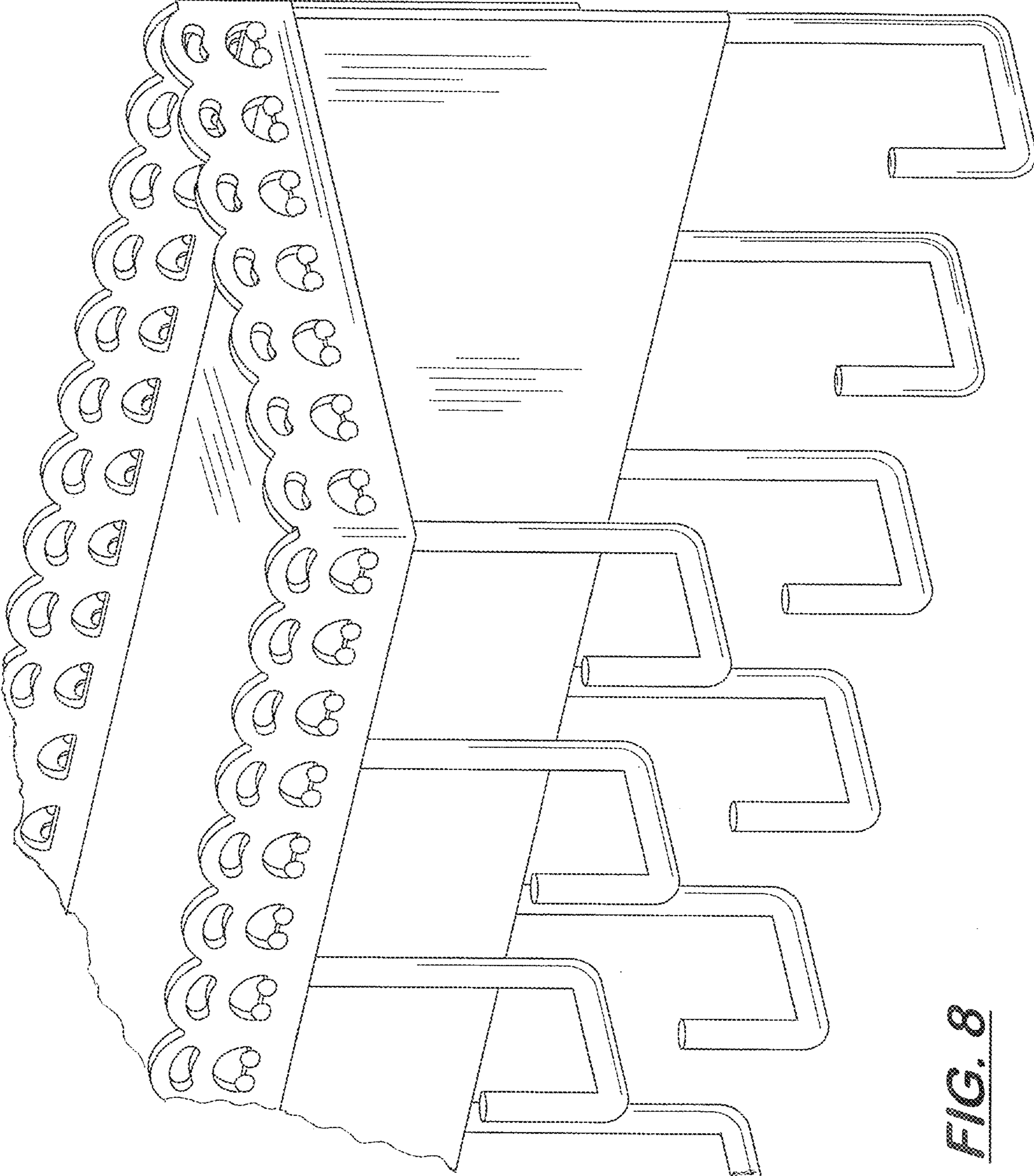

FIG. 8