



US00D879944S

(12) **United States Design Patent**
Ono

(10) **Patent No.:** **US D879,944 S**

(45) **Date of Patent:** **** Mar. 31, 2020**

(54) **INHALER FOR POWDERED
MEDICAMENTS**

(71) Applicant: **NiPPharma Co., Ltd.**, Tokyo (JP)

(72) Inventor: **Shinichi Ono**, Tokyo (JP)

(73) Assignee: **NiPPharma Co., Ltd.**, Tokyo (JP)

(**) Term: **15 Years**

(21) Appl. No.: **29/637,657**

(22) Filed: **Feb. 20, 2018**

(30) **Foreign Application Priority Data**

Aug. 24, 2017 (JP) 2017-018149

(51) **LOC (12) Cl.** **29-02**

(52) **U.S. Cl.**
USPC **D24/110**

(58) **Field of Classification Search**
USPC D24/108, 110, 110.5, 164, 112
CPC A61M 15/009; A61M 2202/064; A61M
15/06; A61M 15/0065; A61M 15/0025;
A61M 15/0026; A61M 15/00
See application file for complete search history.

(56) **References Cited**

U.S. PATENT DOCUMENTS

D613,848 S *	4/2010	Harvey	D24/110
D637,280 S *	5/2011	Harvey	D24/110
D637,281 S *	5/2011	Harvey	D24/110
D637,282 S *	5/2011	Harvey	D24/110
D693,458 S *	11/2013	Wright	D24/110
8,667,961 B2 *	3/2014	Thoemmes	A61M 15/0045 128/203.15
8,763,608 B2 *	7/2014	Meliniotis	A61M 15/0045 128/203.21

2006/0196504 A1 *	9/2006	Augustyn	A61M 15/0045 128/203.15
2008/0196718 A1 *	8/2008	Connell	A61M 15/0045 128/203.15
2008/0308102 A1 *	12/2008	Davies	A61M 15/0045 128/203.15
2010/0059052 A1 *	3/2010	Davies	A61J 1/035 128/203.15
2019/0070373 A1 *	3/2019	Houzego	A61M 15/0075

* cited by examiner

Primary Examiner — Lilyana Bekic

(74) *Attorney, Agent, or Firm* — Pyprus Pte Ltd

(57) **CLAIM**

The ornamental design for an inhaler for powdered medicaments, as shown and described.

DESCRIPTION

FIG. 1 is a front elevation view of the inhaler for powdered medicaments of my new design, in an opened state;
 FIG. 2 is a rear elevation view thereof;
 FIG. 3 is a left side elevation view thereof;
 FIG. 4 is a right side elevation view thereof;
 FIG. 5 is a top plan view thereof;
 FIG. 6 is a bottom plan view thereof;
 FIG. 7 is a front perspective view thereof;
 FIG. 8 is a front elevation view of the inhaler for powdered medicaments, in a closed state;
 FIG. 9 is a rear elevation view thereof;
 FIG. 10 is a left side elevation view thereof;
 FIG. 11 is a right side elevation view thereof;
 FIG. 12 is a top plan view thereof;
 FIG. 13 is a bottom plan view thereof; and,
 FIG. 14 is a front perspective view thereof.

1 Claim, 14 Drawing Sheets

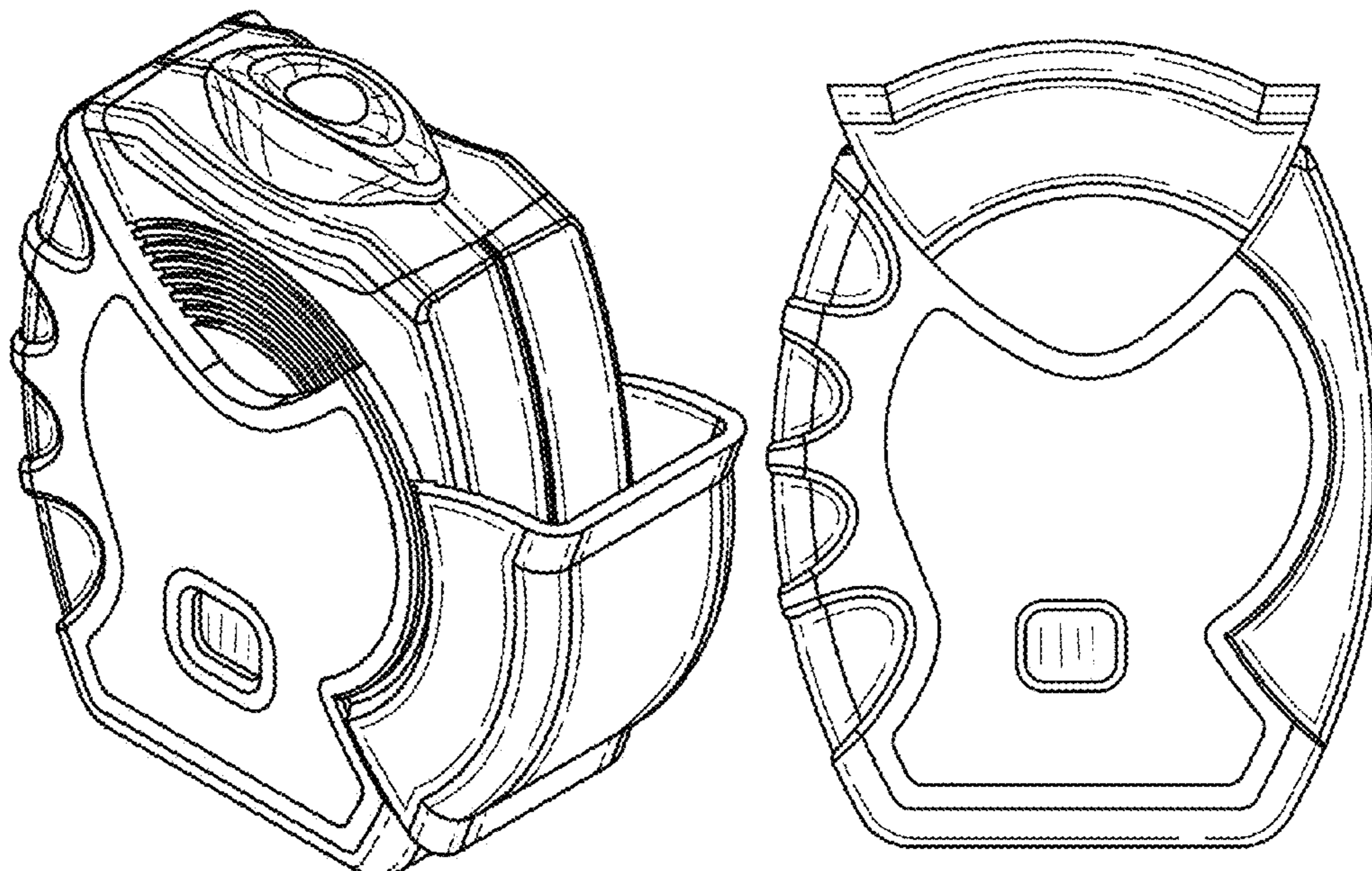

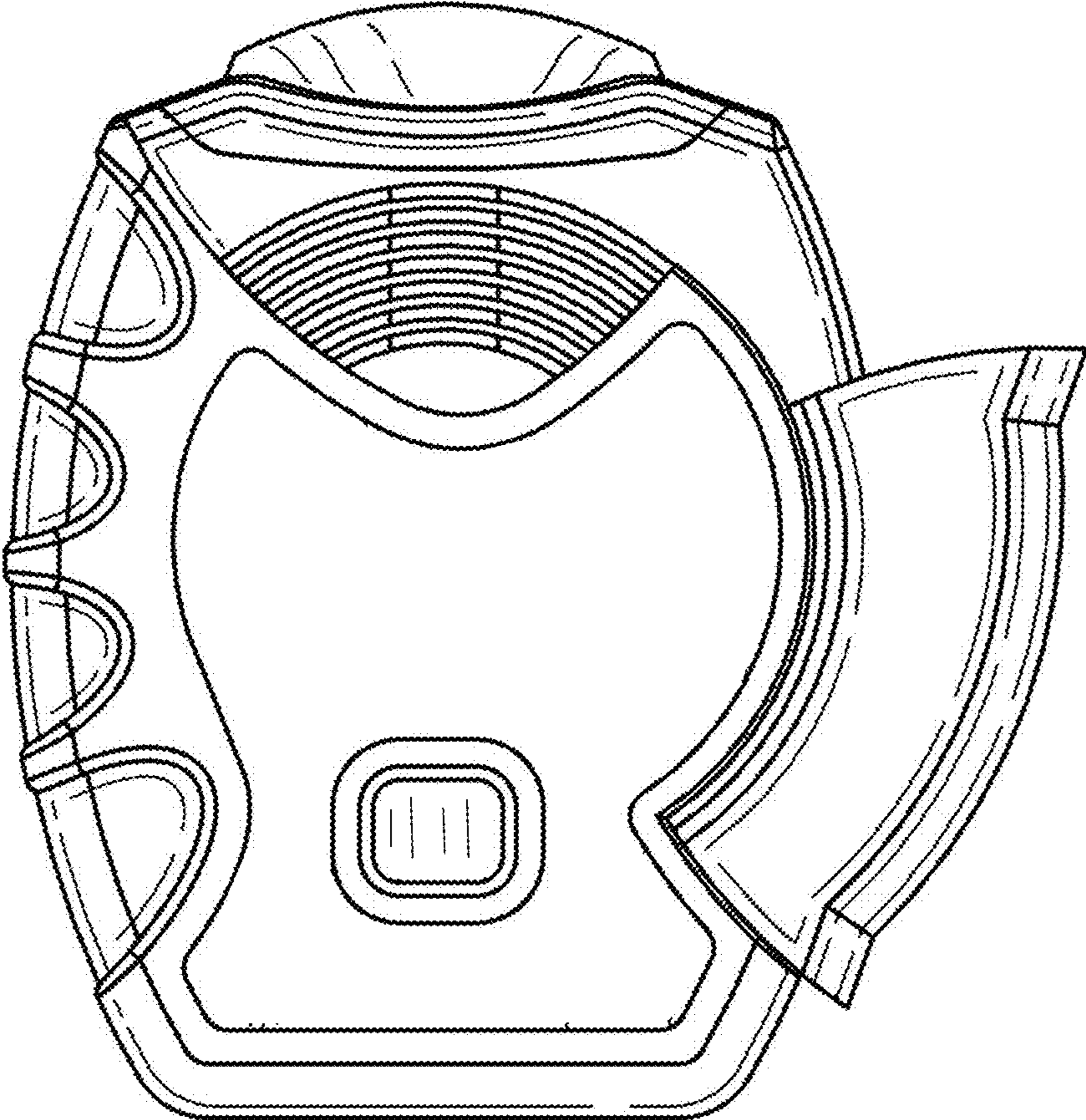

FIG. 1

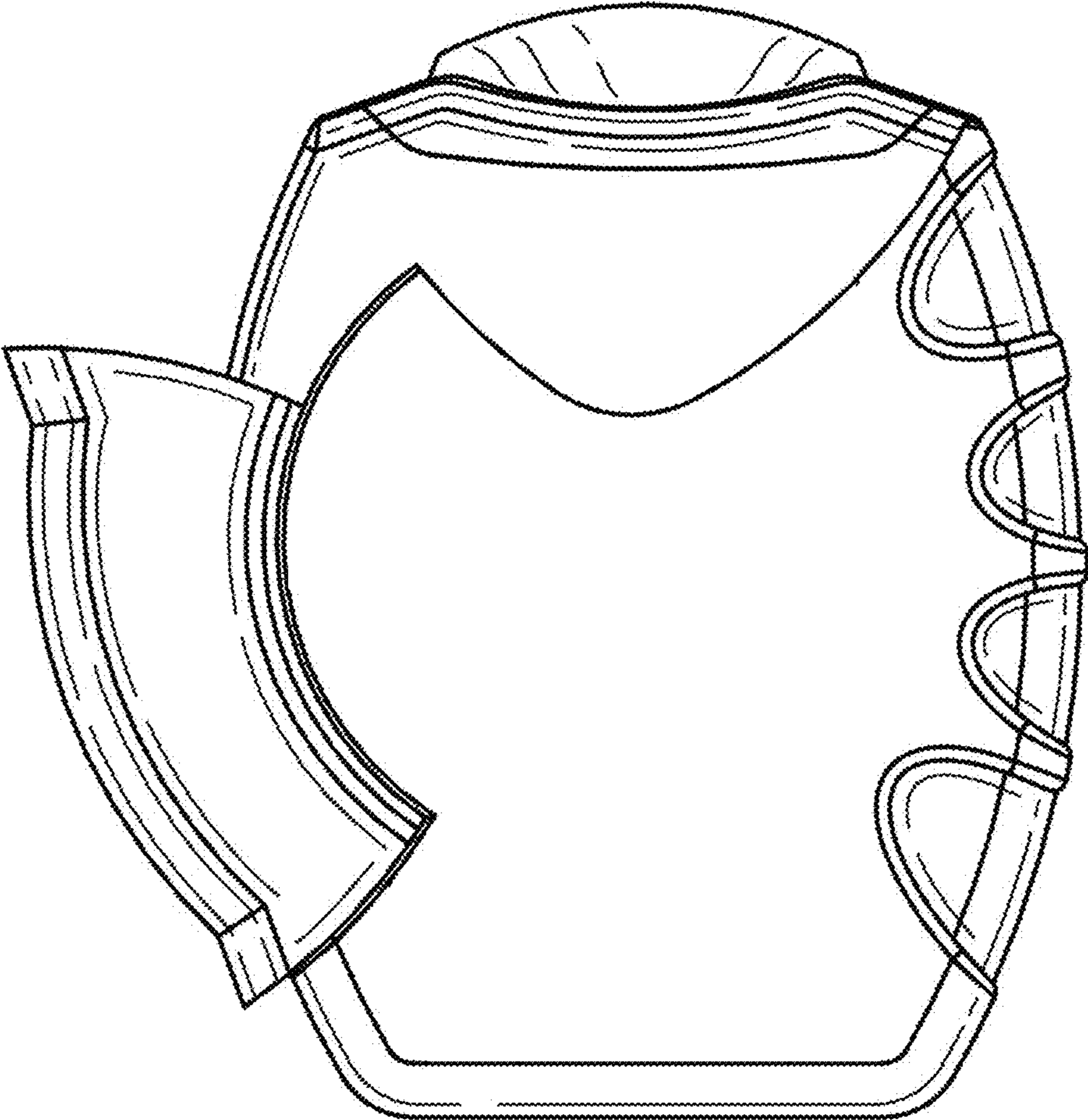

FIG. 2

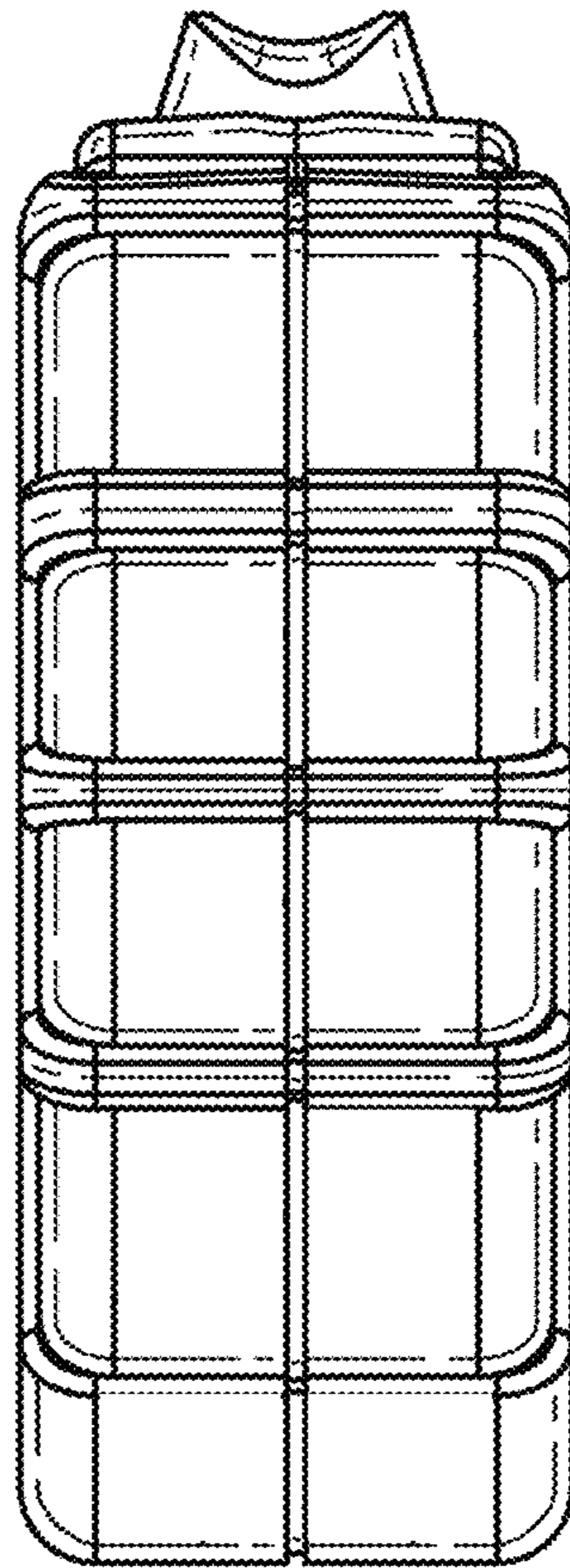

FIG. 3

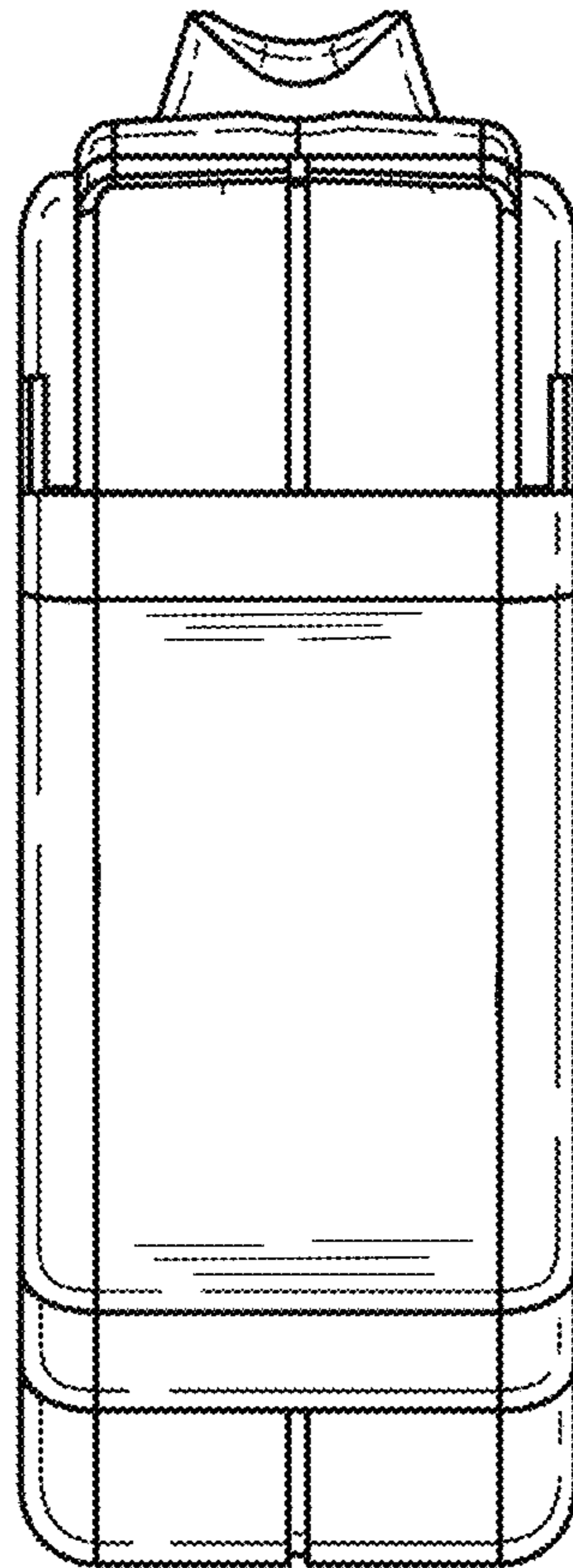

FIG. 4

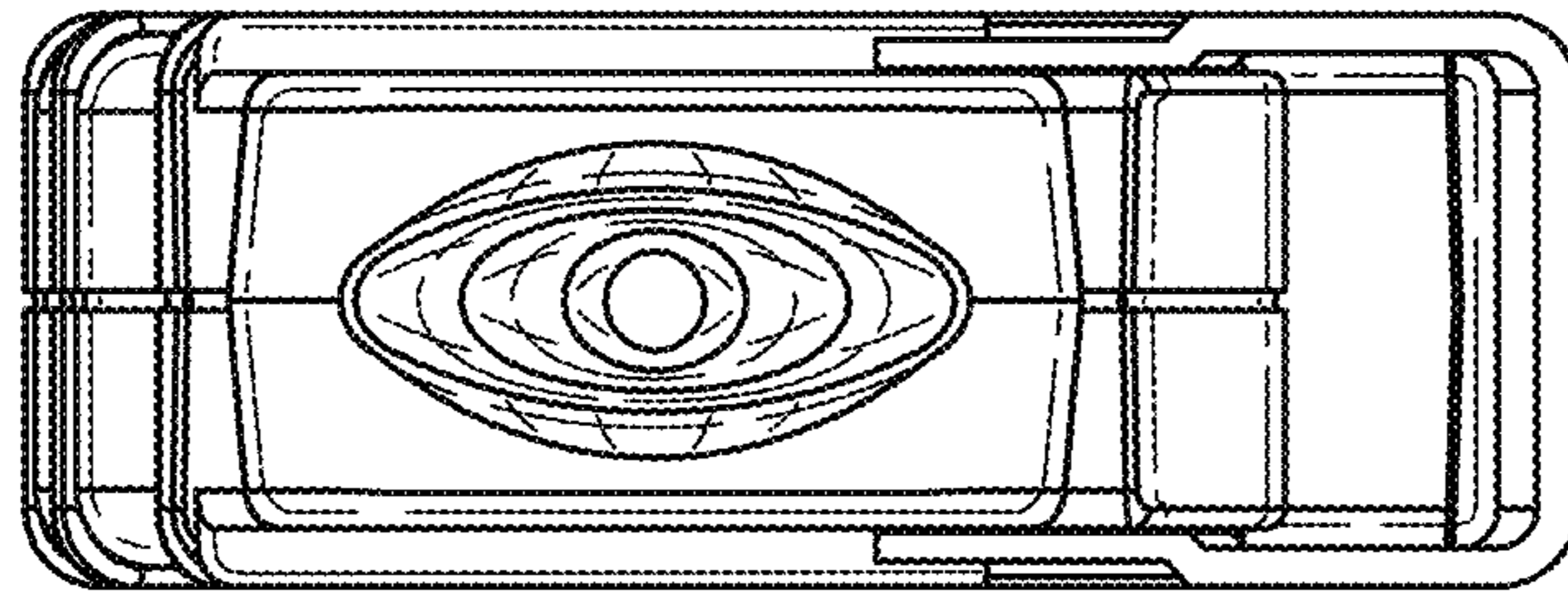

FIG. 5

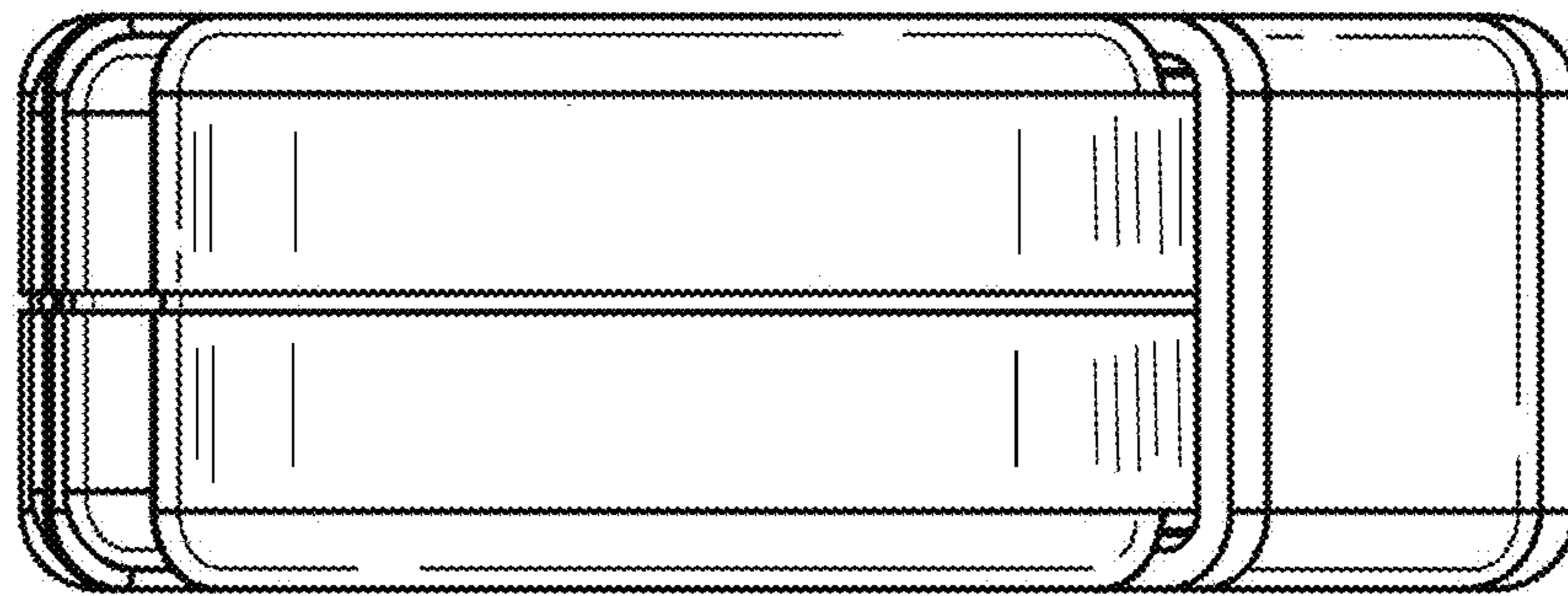

FIG. 6

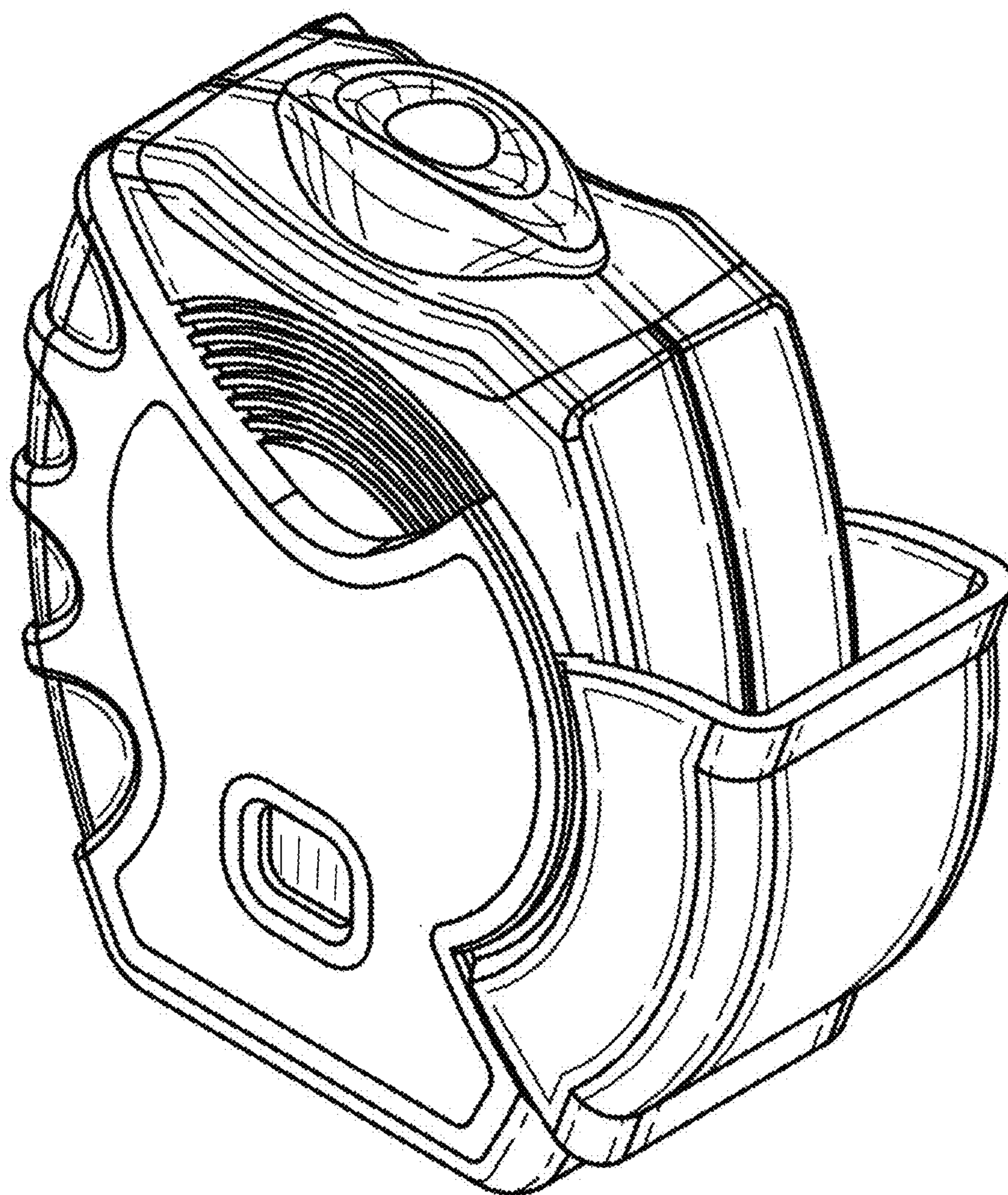

FIG. 7

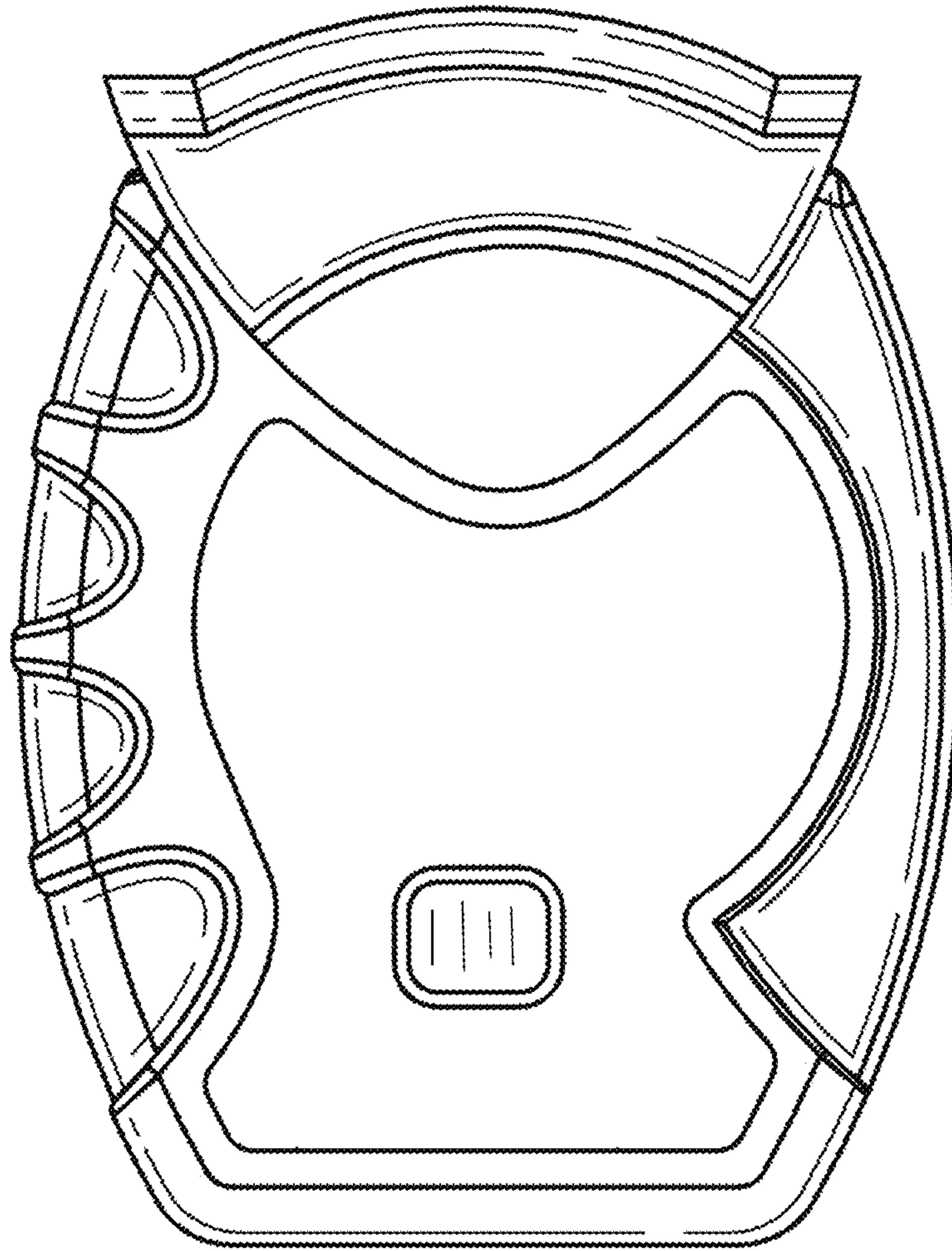

FIG. 8

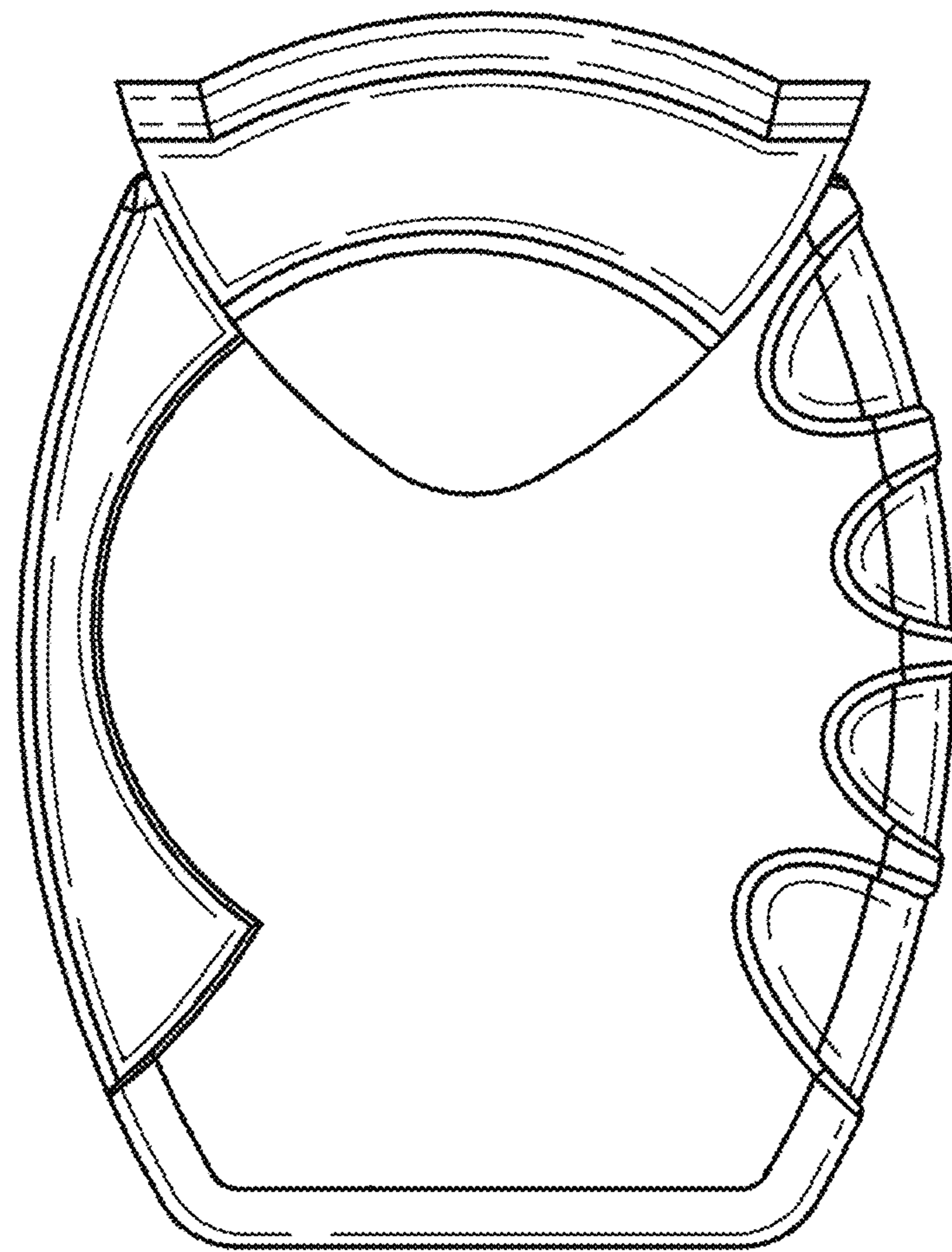

FIG. 9

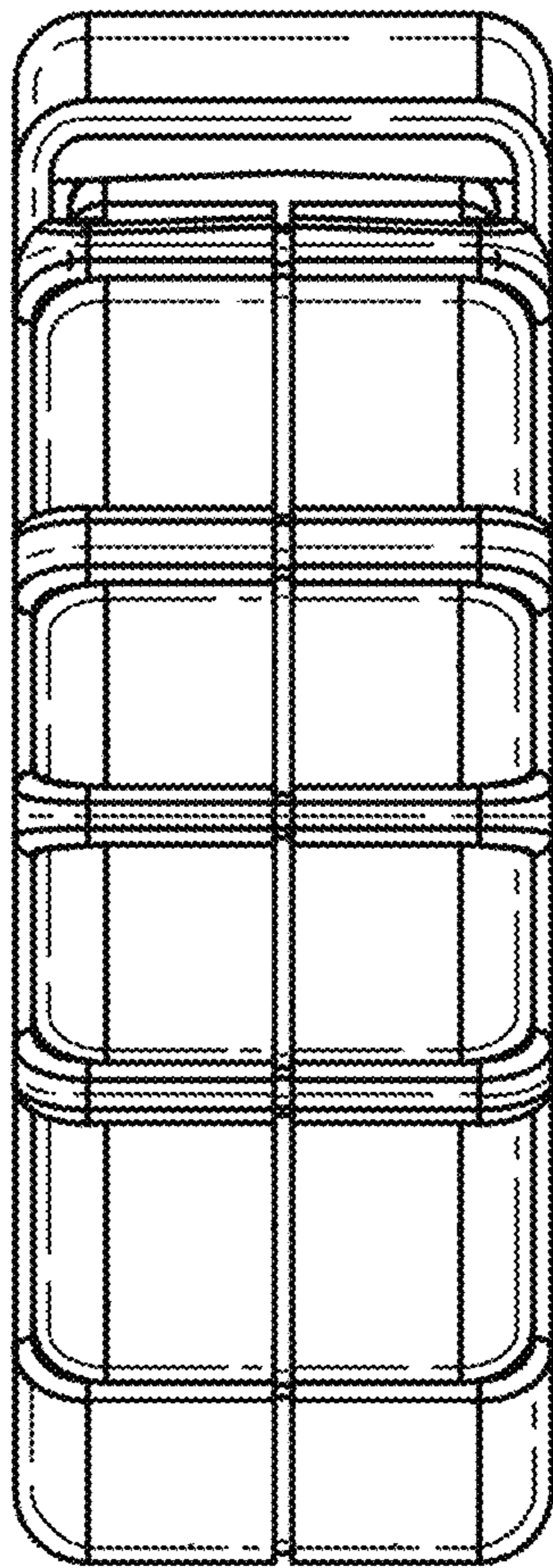

FIG. 10

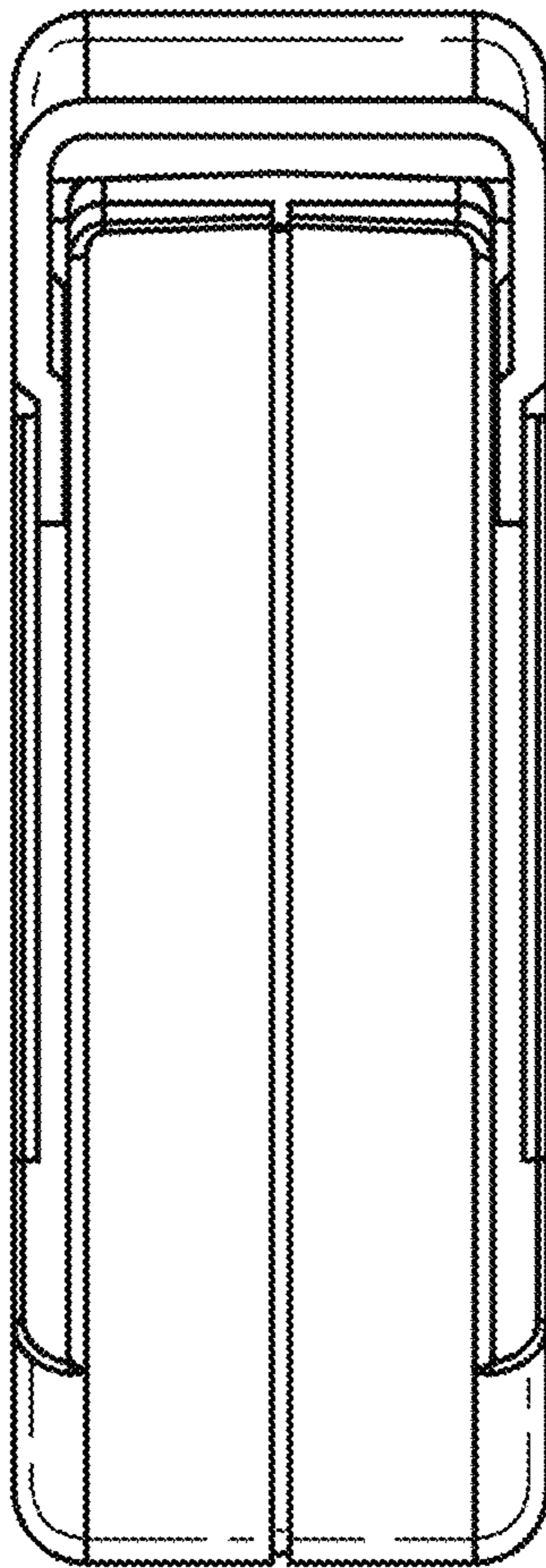

FIG. 11

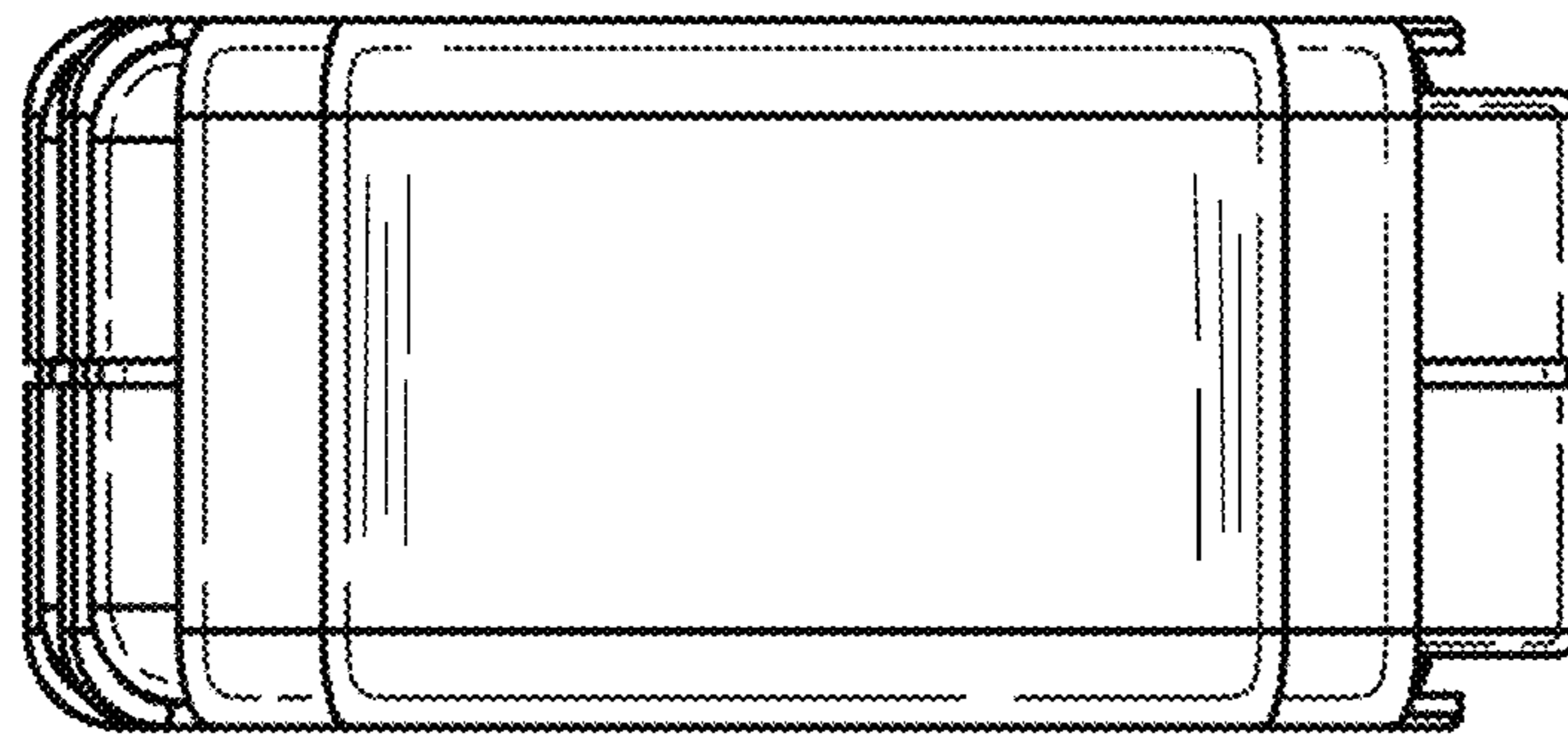

FIG. 12

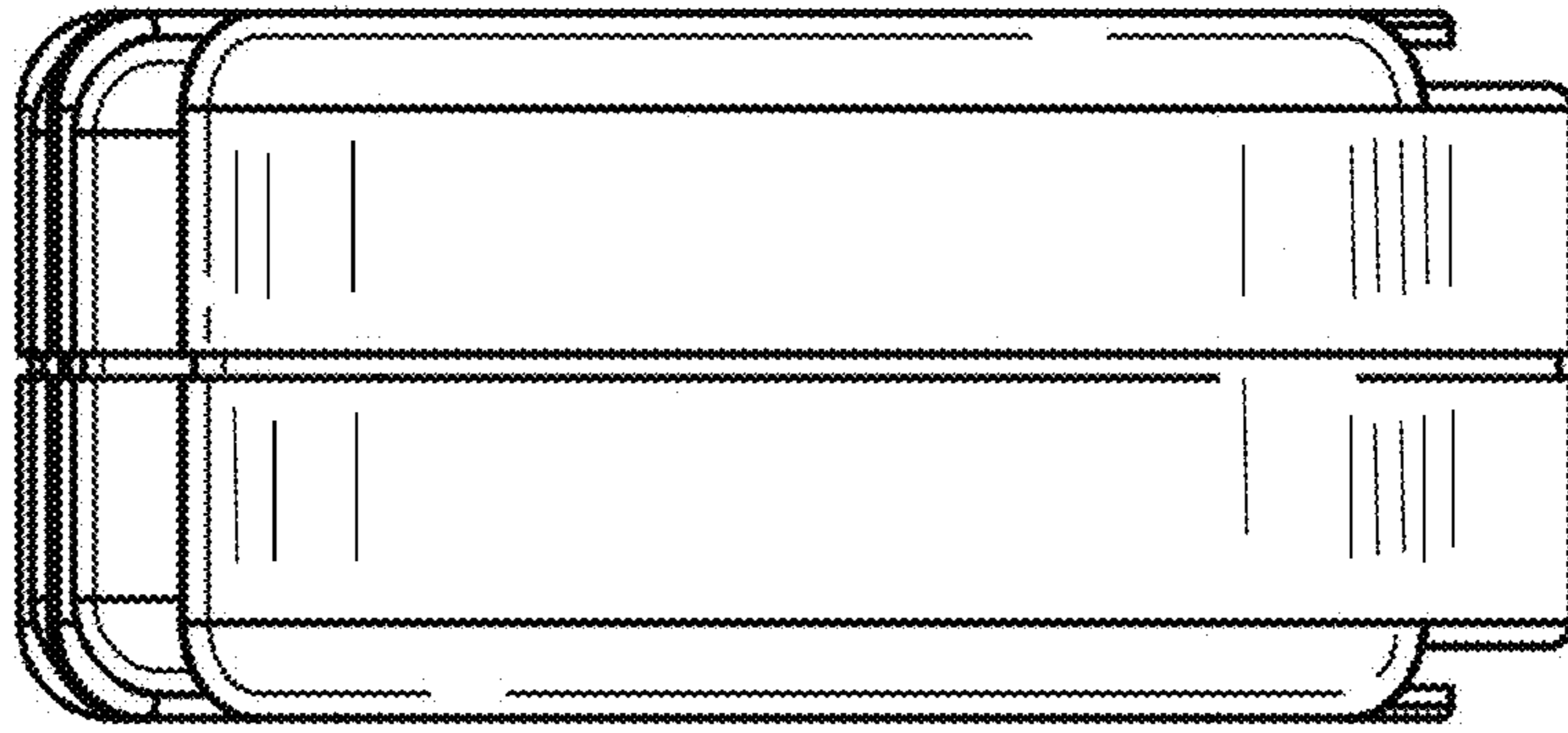

FIG. 13

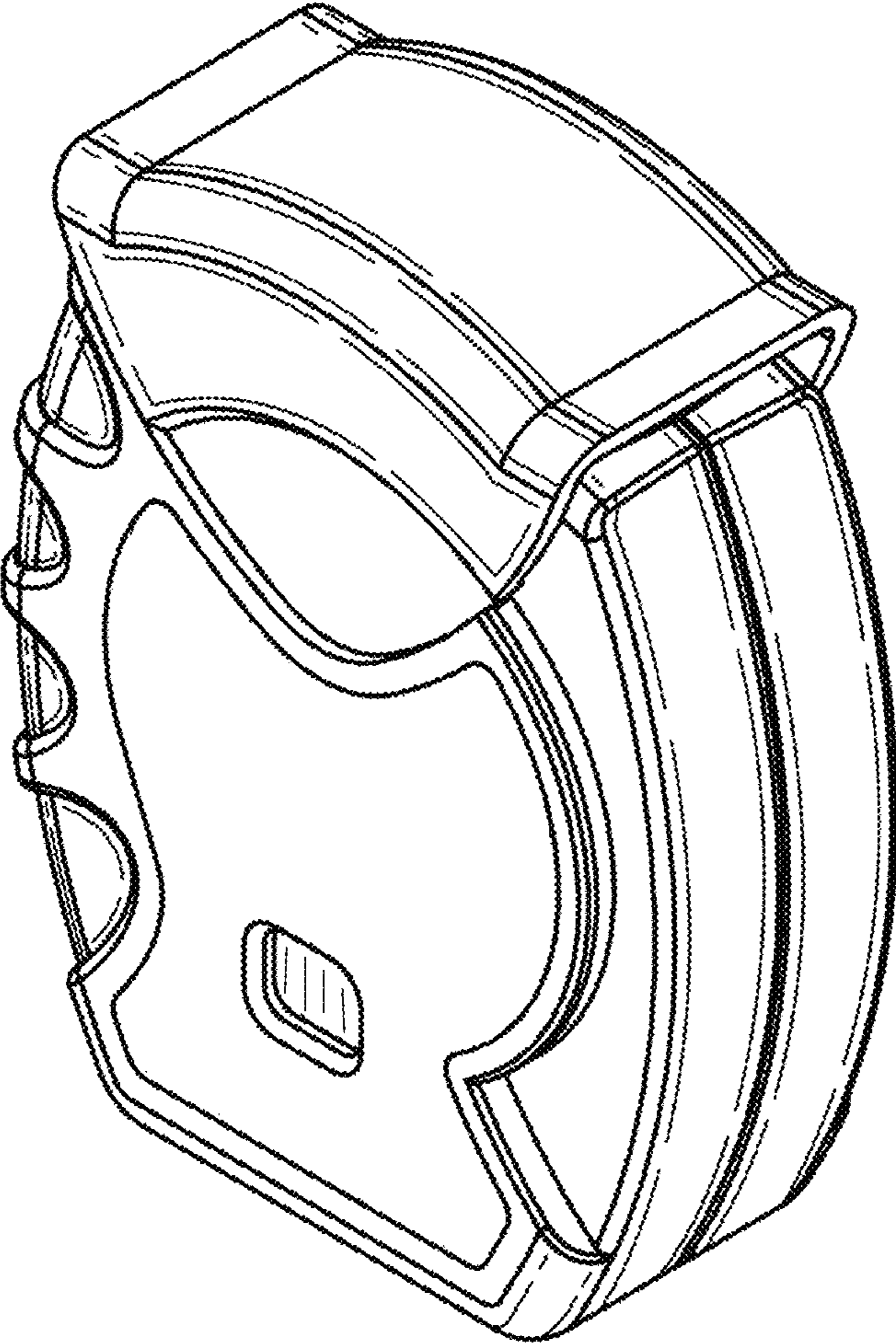

FIG. 14