



US00D879876S

(12) **United States Design Patent**  
**Lir**

(10) **Patent No.:** **US D879,876 S**  
(45) **Date of Patent:** **\*\* Mar. 31, 2020**

- (54) **PEN**
- (71) Applicant: **Kemberburgaz Ofis ve Okul Gereçleri Sanayi Ticaret Anonim Şirketi, Istanbul (TR)**
- (72) Inventor: **Numan Lir, Istanbul (TR)**
- (73) Assignee: **Kemberburgaz Ofis ve Okul Gereçleri Sanayi Ticaret Anonim Şirketi, Istanbul (TR)**
- (\*\*) Term: **15 Years**
- (21) Appl. No.: **29/656,822**
- (22) Filed: **Jul. 17, 2018**

- 3,288,115 A \* 11/1966 Hechtle ..... B43K 24/084 401/110
- 3,825,976 A \* 7/1974 Moore ..... B43K 25/02 24/11 F
- D442,226 S \* 5/2001 Briggli ..... D19/175
- D487,114 S \* 2/2004 Santa Maria ..... D19/201
- D501,029 S \* 1/2005 Liang ..... D19/201
- D510,104 S \* 9/2005 Qiu ..... D19/174
- D520,059 S \* 5/2006 Shibata ..... D19/174
- D534,213 S \* 12/2006 Hageman ..... D19/121
- D562,389 S \* 2/2008 Ikeda ..... D19/172
- D576,213 S \* 9/2008 Fei ..... D19/172
- D576,675 S \* 9/2008 Kent ..... D19/174
- D583,413 S \* 12/2008 Li ..... D19/172
- D624,965 S \* 10/2010 Li ..... D19/172
- D651,244 S \* 12/2011 Yuan ..... D19/172
- D651,245 S \* 12/2011 Yuan ..... D19/172
- D656,193 S \* 3/2012 Yuan ..... D19/172
- D664,197 S \* 7/2012 Casciotti ..... D19/201
- D665,025 S \* 8/2012 Li ..... D19/172
- D667,882 S \* 9/2012 Uchiyama ..... D19/172
- D692,484 S \* 10/2013 Laemle ..... D19/172
- D762,775 S \* 8/2016 Zhang ..... D19/172
- D780,268 S \* 2/2017 Laemle ..... D19/170

**Related U.S. Application Data**

(63) Continuation-in-part of application No. 29/601,749, filed on Apr. 26, 2017, now abandoned.

(51) **LOC (12) Cl.** ..... **19-06**  
 (52) **U.S. Cl.**  
 USPC ..... **D19/172; D19/904; D19/912; D19/914; D19/932**

(58) **Field of Classification Search**  
 USPC ..... **D19/115-204; D14/411**  
 CPC . **B43K 5/005; B43K 7/12; B43K 8/04; B43K 8/06; B43K 19/00; B43K 19/02; B43K 19/14; B43K 21/006; B43K 21/06**  
 See application file for complete search history.

(56) **References Cited**

**U.S. PATENT DOCUMENTS**

- 2,800,883 A \* 7/1957 Sams ..... B43K 24/08 401/104
- 2,946,312 A \* 7/1960 Burnie ..... B43K 7/02 401/44

(Continued)

*Primary Examiner* — Elizabeth A. Albert

(74) *Attorney, Agent, or Firm* — Bayramoglu Law Offices LLC

(57) **CLAIM**

The ornamental design for a pen, as shown and described.

**DESCRIPTION**

FIG. 1 is a perspective view of a pen showing my new design;  
 FIG. 2 is a front view thereof;  
 FIG. 3 is a rear view thereof;  
 FIG. 4 is a right side view thereof;  
 FIG. 5 is a left side view thereof;  
 FIG. 6 is a bottom view thereof; and,  
 FIG. 7 is a top view thereof.

**1 Claim, 7 Drawing Sheets**

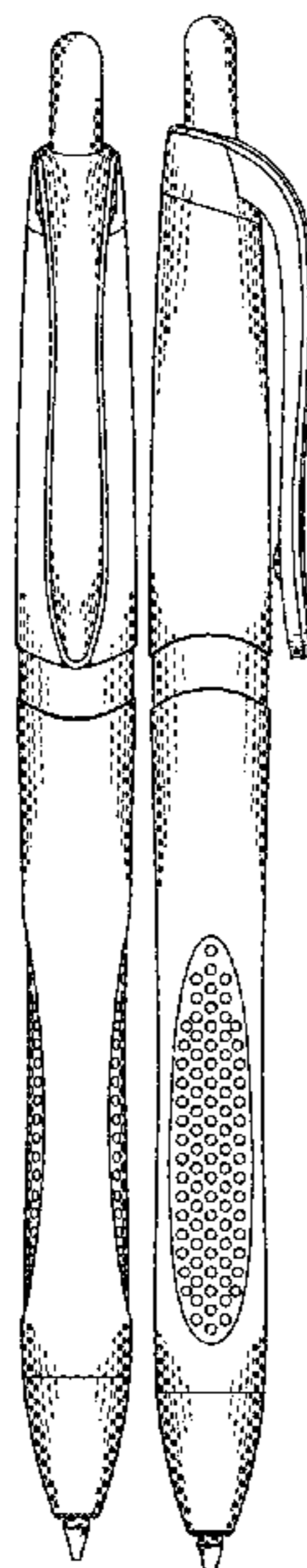

(56)

**References Cited**

U.S. PATENT DOCUMENTS

D815,686 S \* 4/2018 Nakata ..... D19/172  
D860,317 S \* 9/2019 Laemle ..... D19/197

\* cited by examiner

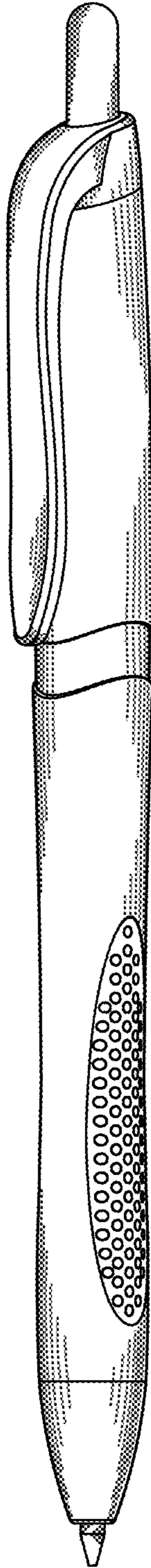

FIG. 1

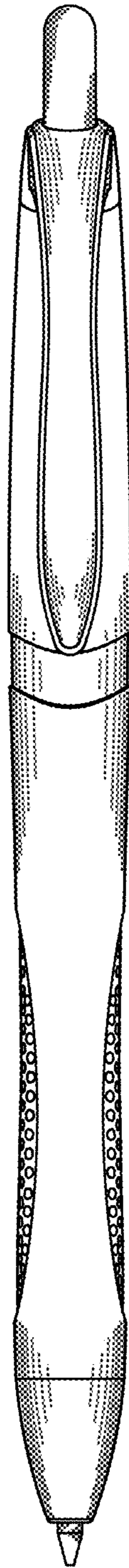

FIG. 2

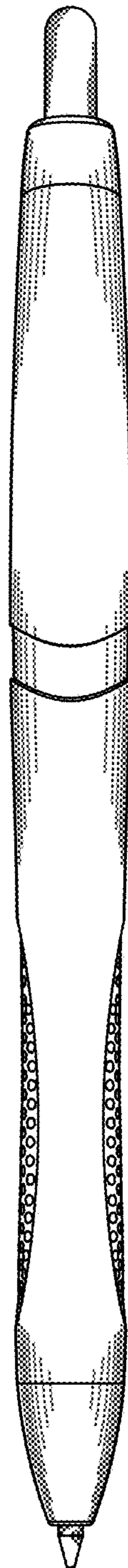

FIG. 3

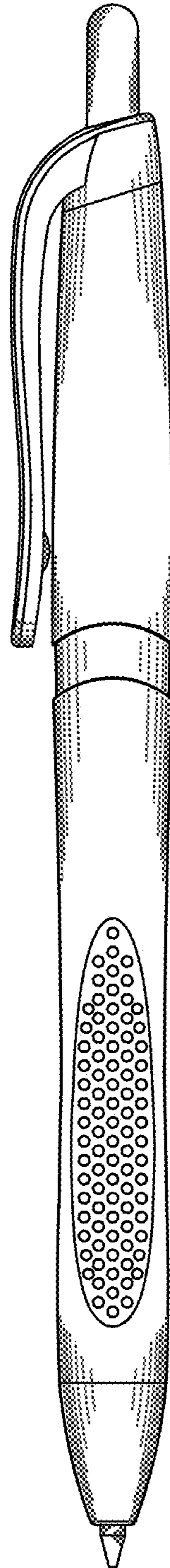

FIG. 4

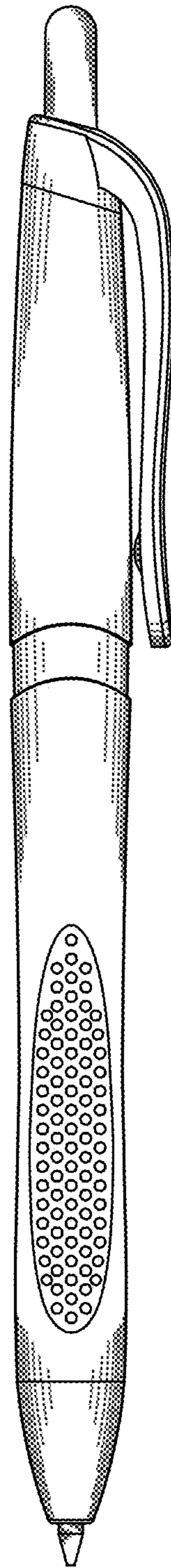

FIG. 5

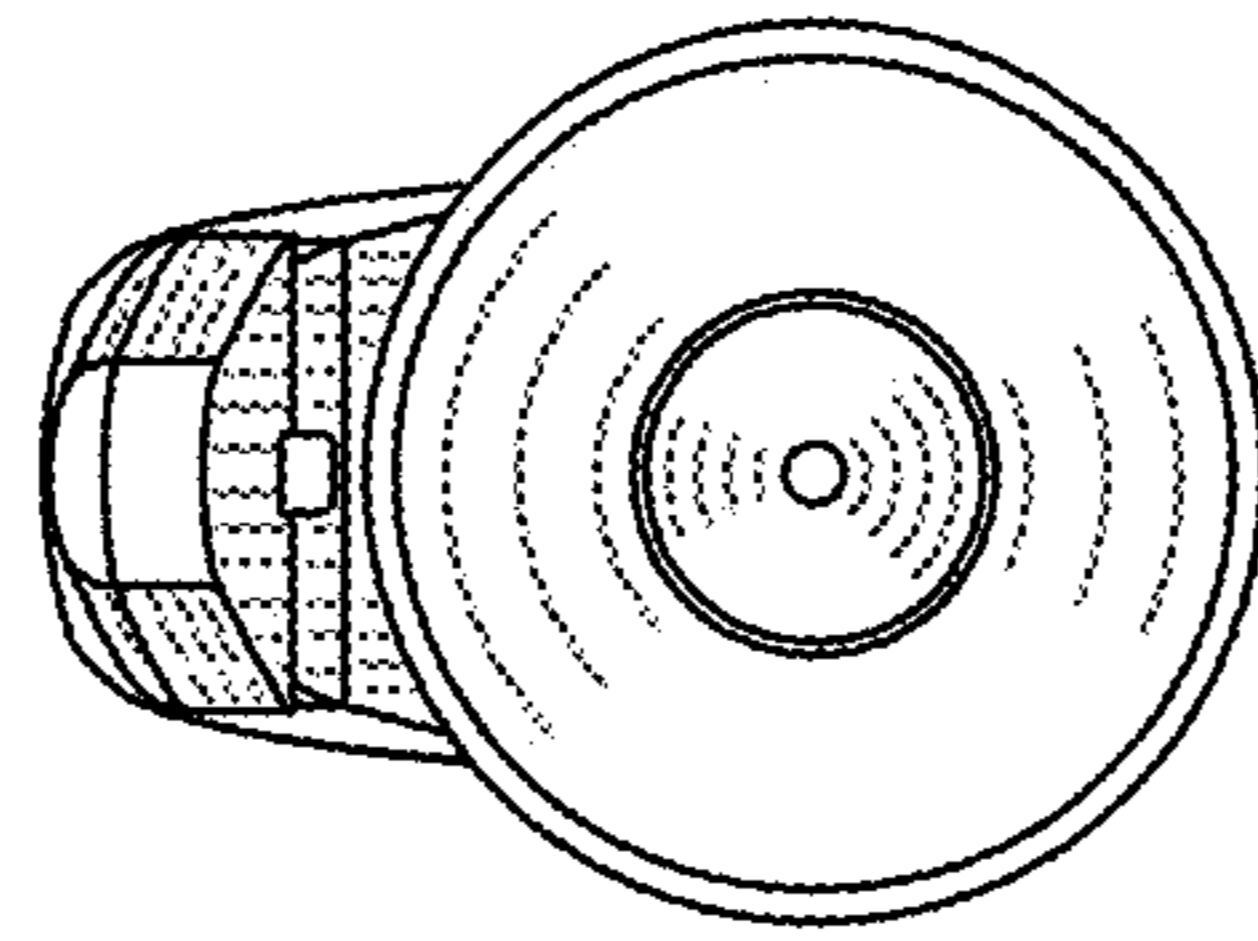

FIG. 6



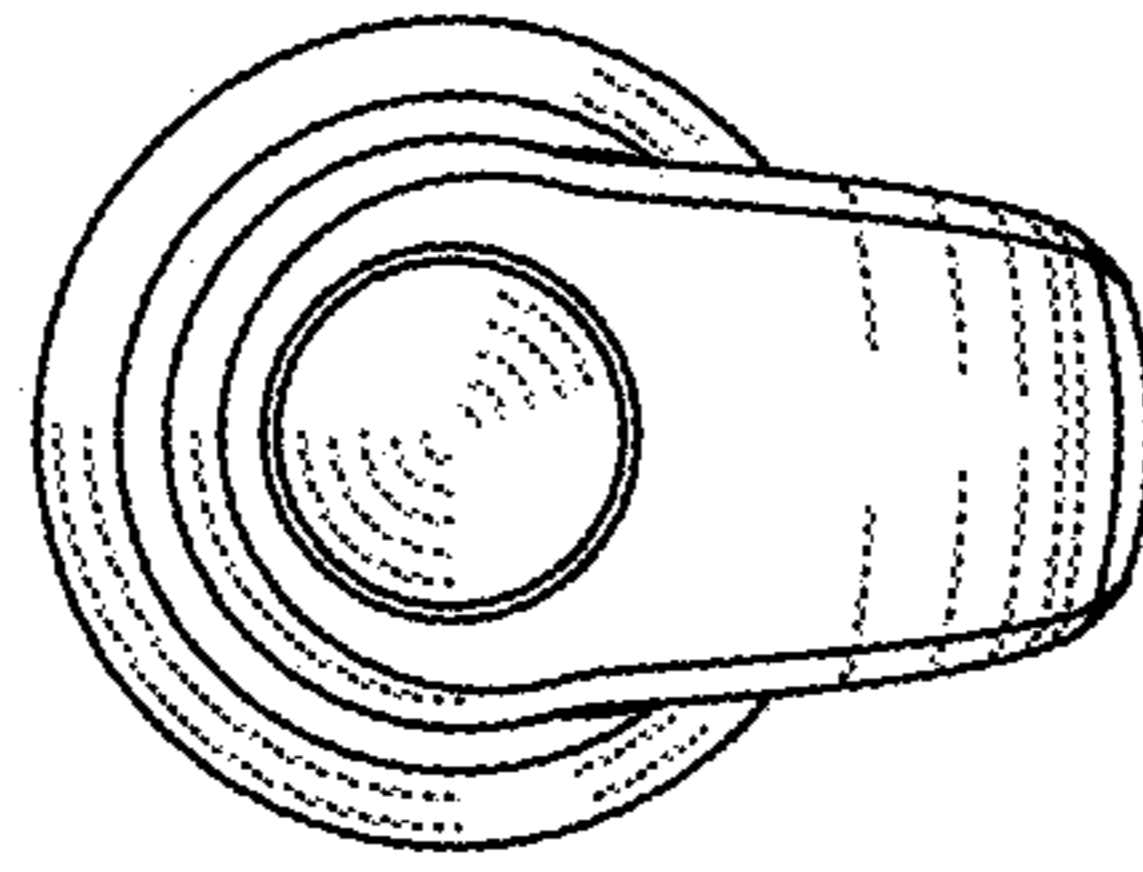

FIG. 7