



US00D879853S

(12) **United States Design Patent**
Baba et al.

(10) **Patent No.:** **US D879,853 S**
(45) **Date of Patent:** **** Mar. 31, 2020**

(54) **COMMUNICATION ROBOT**
(71) Applicant: **Hitachi, Ltd.**, Chiyoda-ku, Tokyo (JP)
(72) Inventors: **Ryusuke Baba**, Tokyo (JP); **Azusa Amino**, Tokyo (JP)
(73) Assignee: **Hitachi, Ltd.**, Tokyo (JP)
(**) Term: **15 Years**

D822,770 S *	7/2018	Hsiao	D21/578
D823,367 S *	7/2018	Tsai	D15/199
D825,010 S *	8/2018	Osentoski	D21/578
D836,690 S *	12/2018	Kim	D15/199
D843,498 S *	3/2019	Clerc	D21/578
D852,861 S *	7/2019	Lee	D15/199
D855,094 S *	7/2019	Li	D15/199
D857,774 S *	8/2019	Wang	D15/199
D858,484 S *	9/2019	Liu	D14/207
D866,684 S *	11/2019	Fruh	D21/578
D868,907 S *	12/2019	Liu	D21/578

* cited by examiner

(21) Appl. No.: **29/672,094**
(22) Filed: **Dec. 3, 2018**

Primary Examiner — Khawaja Anwar
(74) *Attorney, Agent, or Firm* — Crowell & Moring LLP

(30) **Foreign Application Priority Data**
Jun. 4, 2018 (JP) 2018-012276
(51) **LOC (12) Cl.** **15-99**
(52) **U.S. Cl.**
USPC **D15/199**
(58) **Field of Classification Search**
USPC D15/199; D12/128–133
CPC . B24B 37/34; B60R 2021/0027; B60R 21/00;
G05B 19/042; G05B 19/402; G05B
19/418; G05B 19/41835; G05B 19/42;
G05B 2219/25145; G05B 2219/39082;
G05B 2219/39191; G05B 2219/39322;
G05B 2219/45031
See application file for complete search history.

(57) **CLAIM**
The ornamental design for a communication robot, as shown and described.

(56) **References Cited**
U.S. PATENT DOCUMENTS
D761,894 S * 7/2016 Ho D15/199
D822,740 S * 7/2018 Tsai D15/199

DESCRIPTION
FIG. 1 is a front, top and right side perspective view of a communication robot according to the design;
FIG. 2 is a front elevational view thereof;
FIG. 3 is a right side elevational view thereof;
FIG. 4 is a left side elevational view thereof;
FIG. 5 is a rear elevational view thereof;
FIG. 6 is a top plan view thereof;
FIG. 7 is a bottom plan view thereof; and,
FIG. 8 is a cross-sectional view taken along line 8-8 of FIG. 2.
The broken lines are for illustrative purposes only and form no part of the claimed design.
The hatching shown in FIG. 8 represents unclaimed subject matter and form no part of the claimed design.

1 Claim, 8 Drawing Sheets

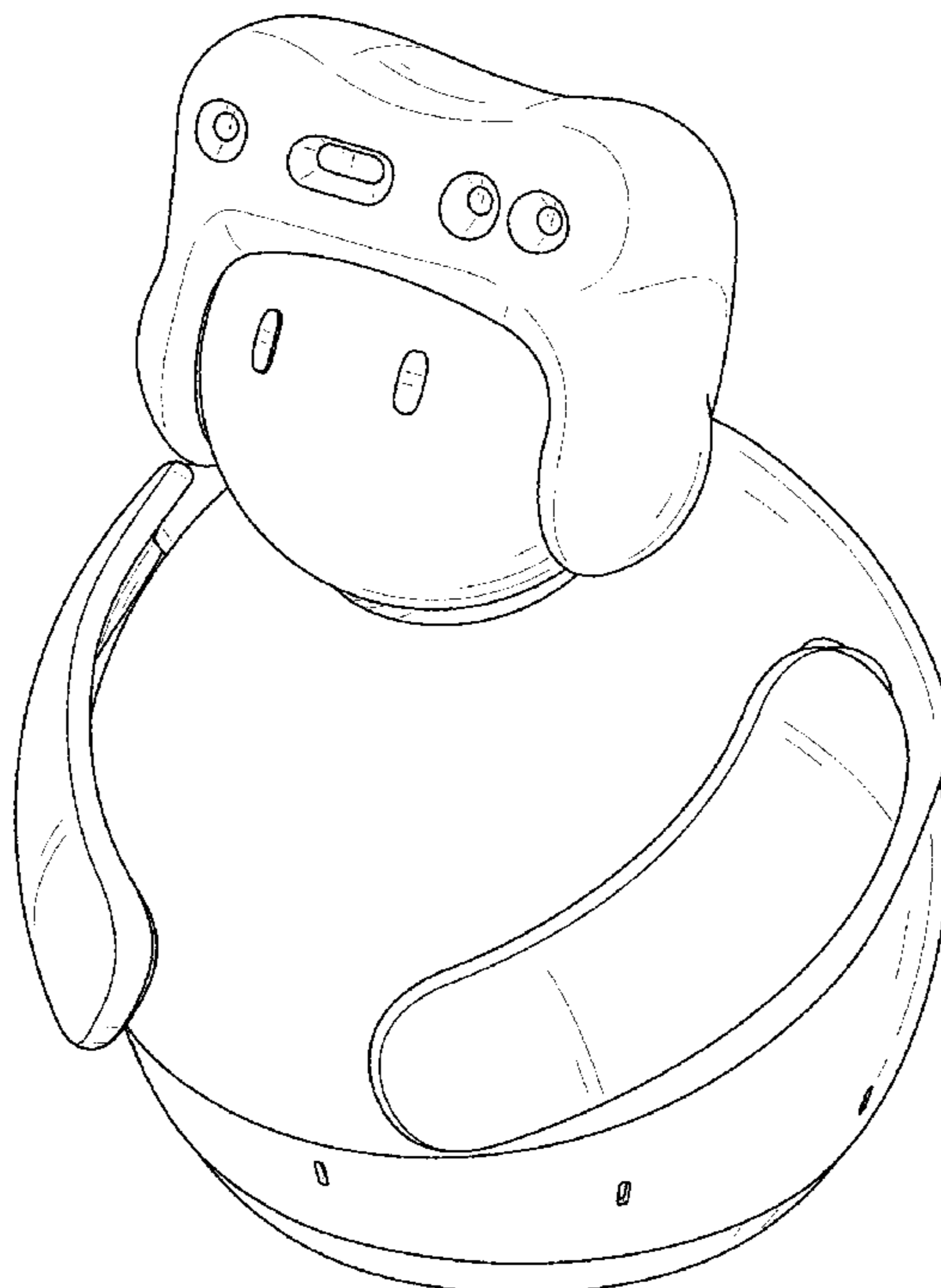

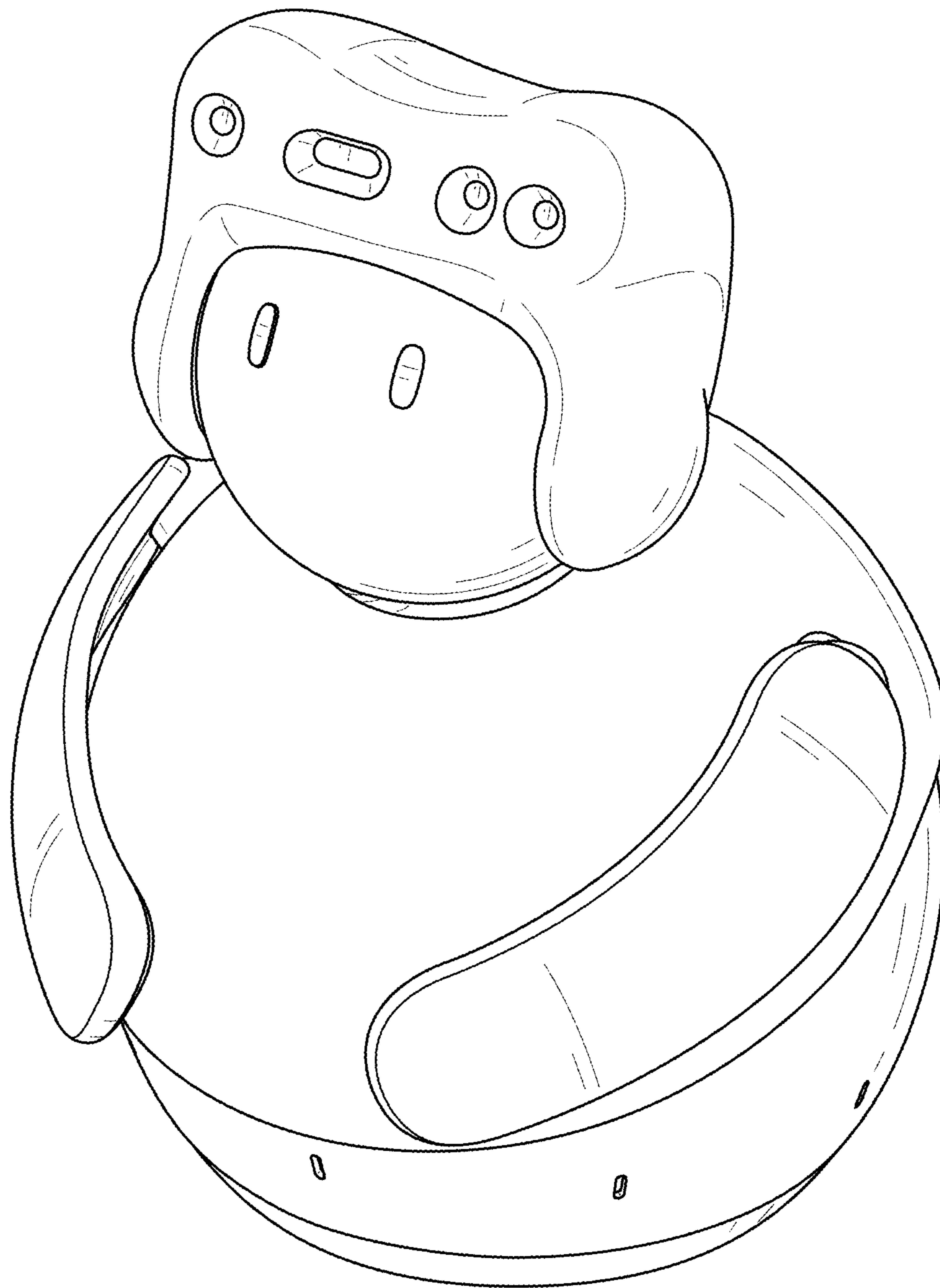

FIG. 1

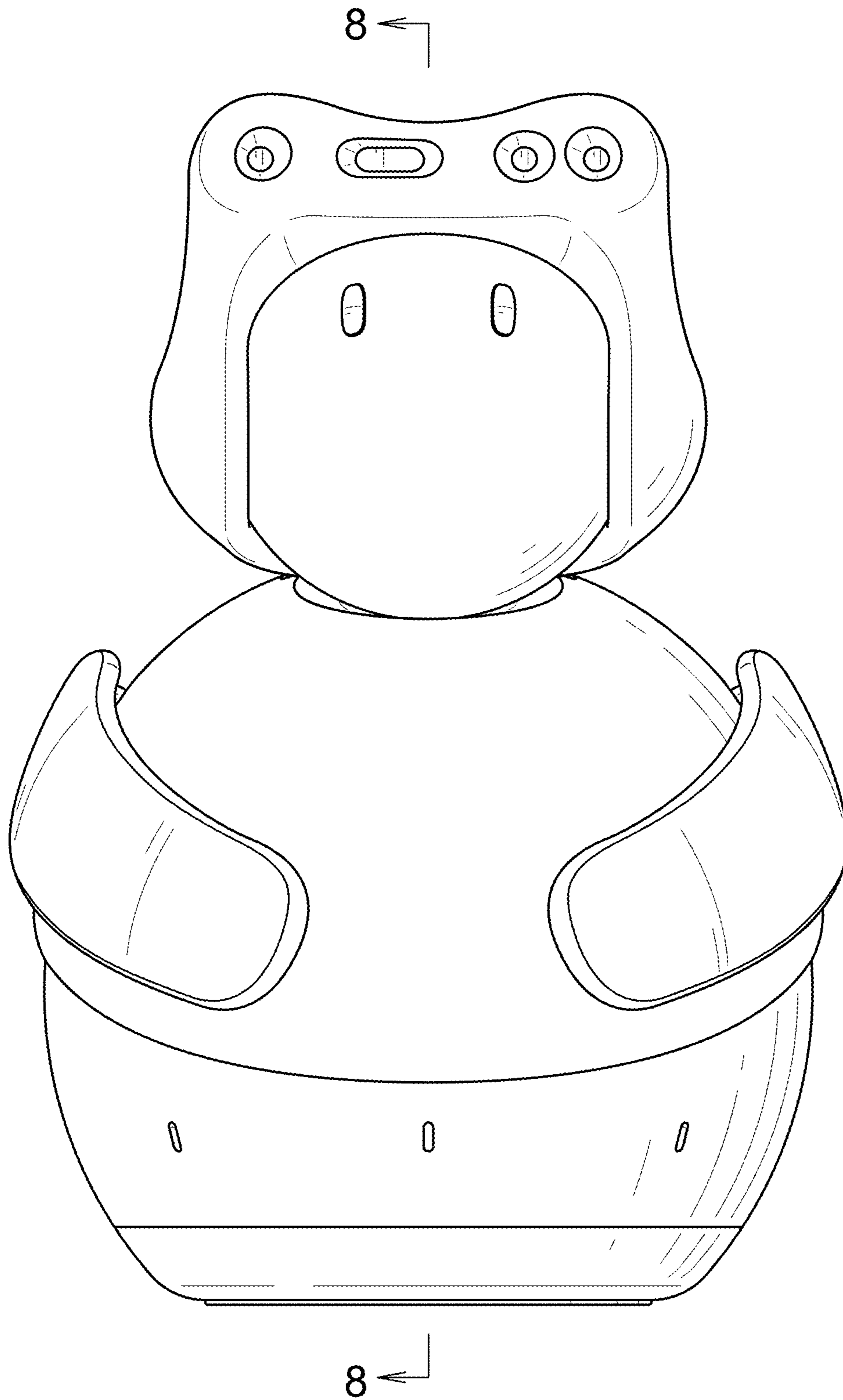

FIG. 2

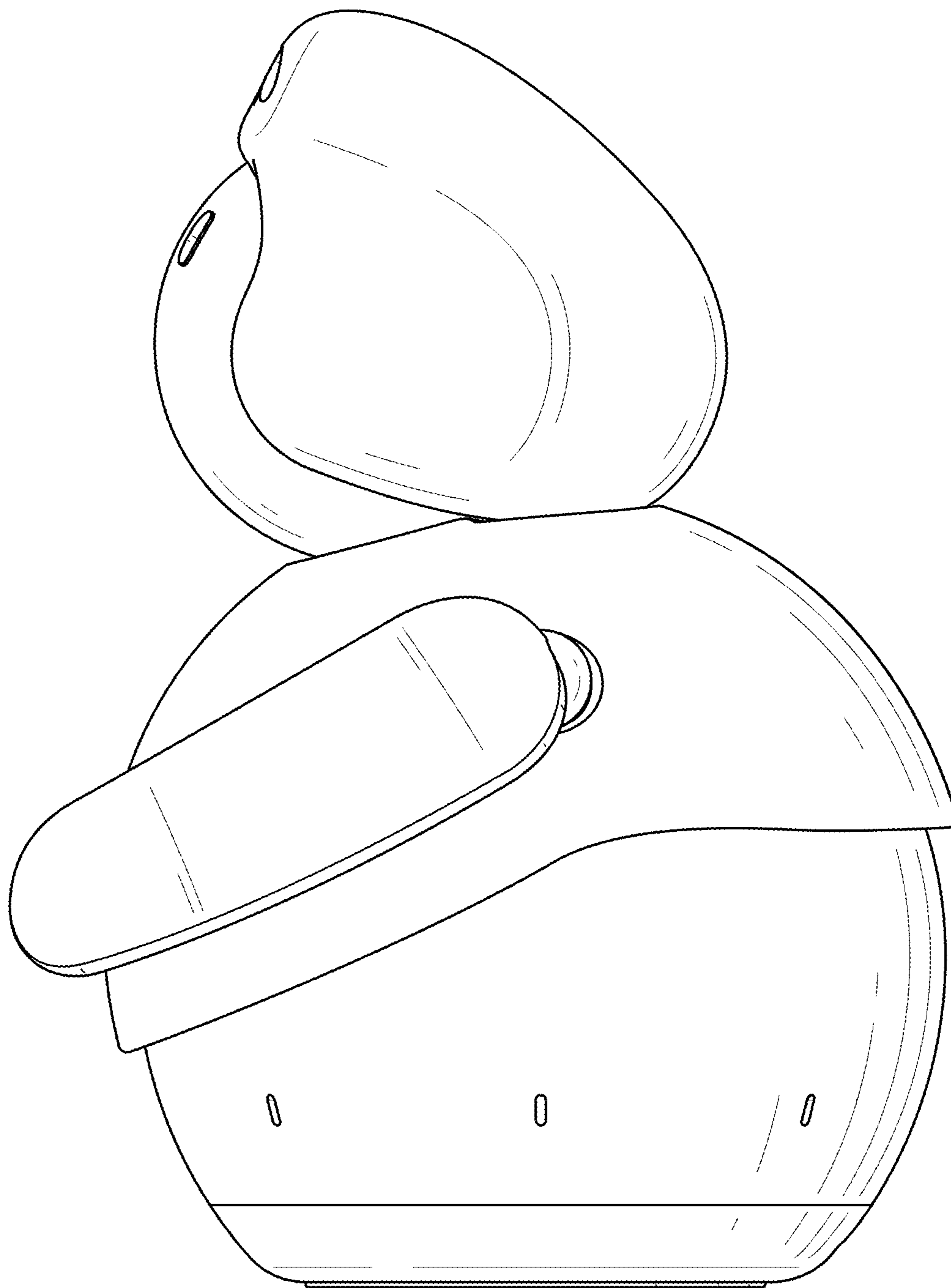

FIG. 3

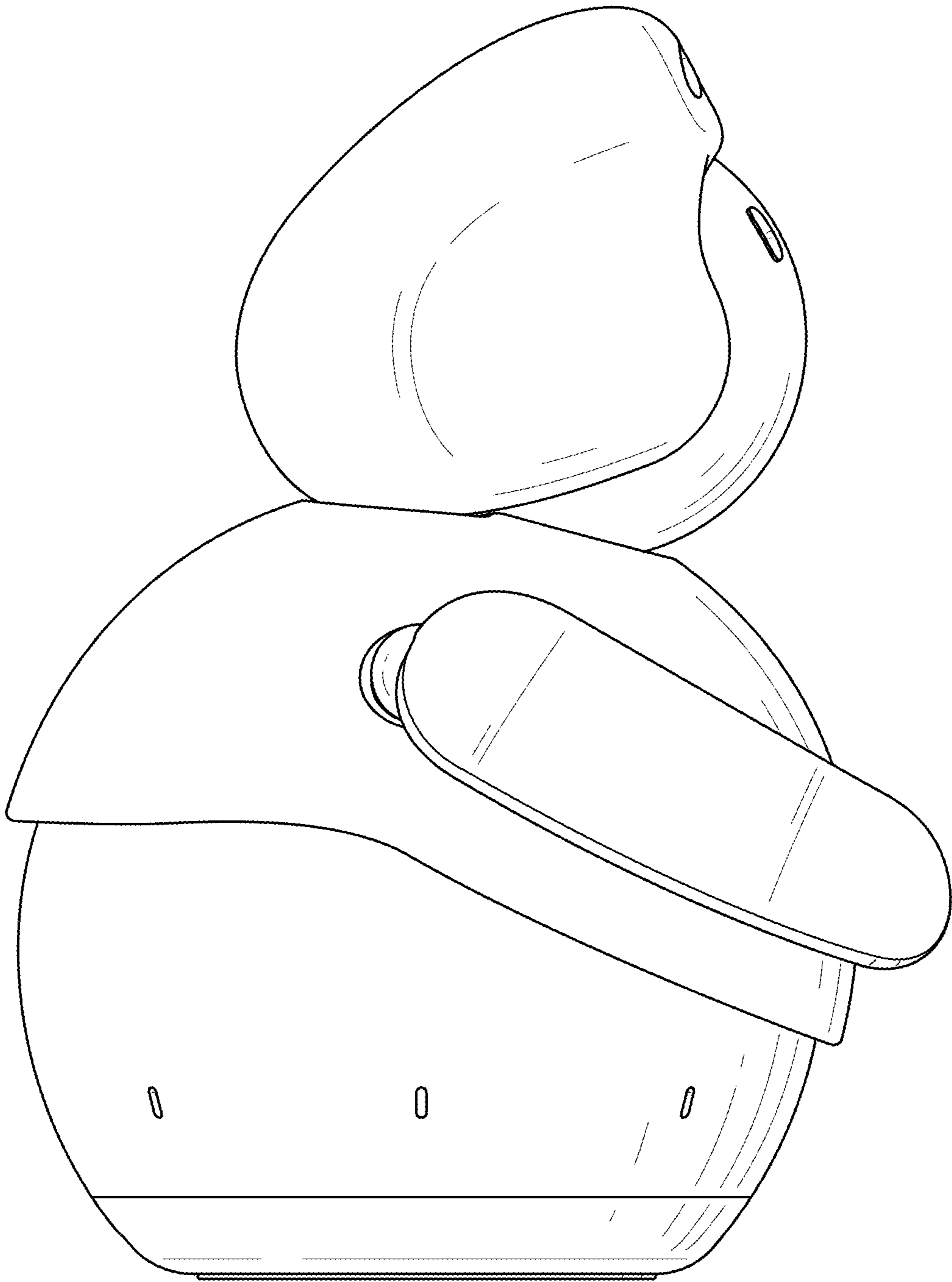

FIG. 4

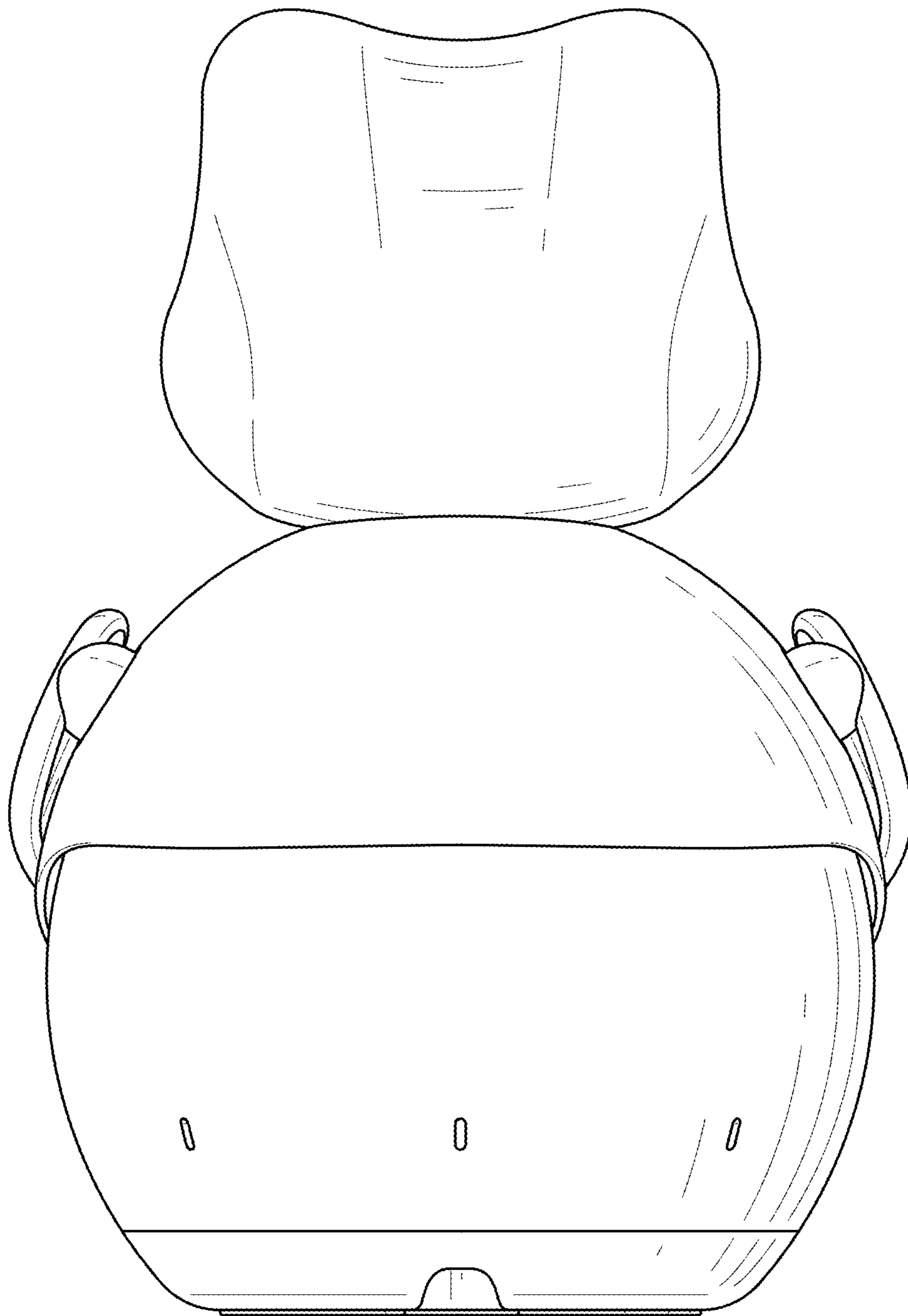

FIG. 5

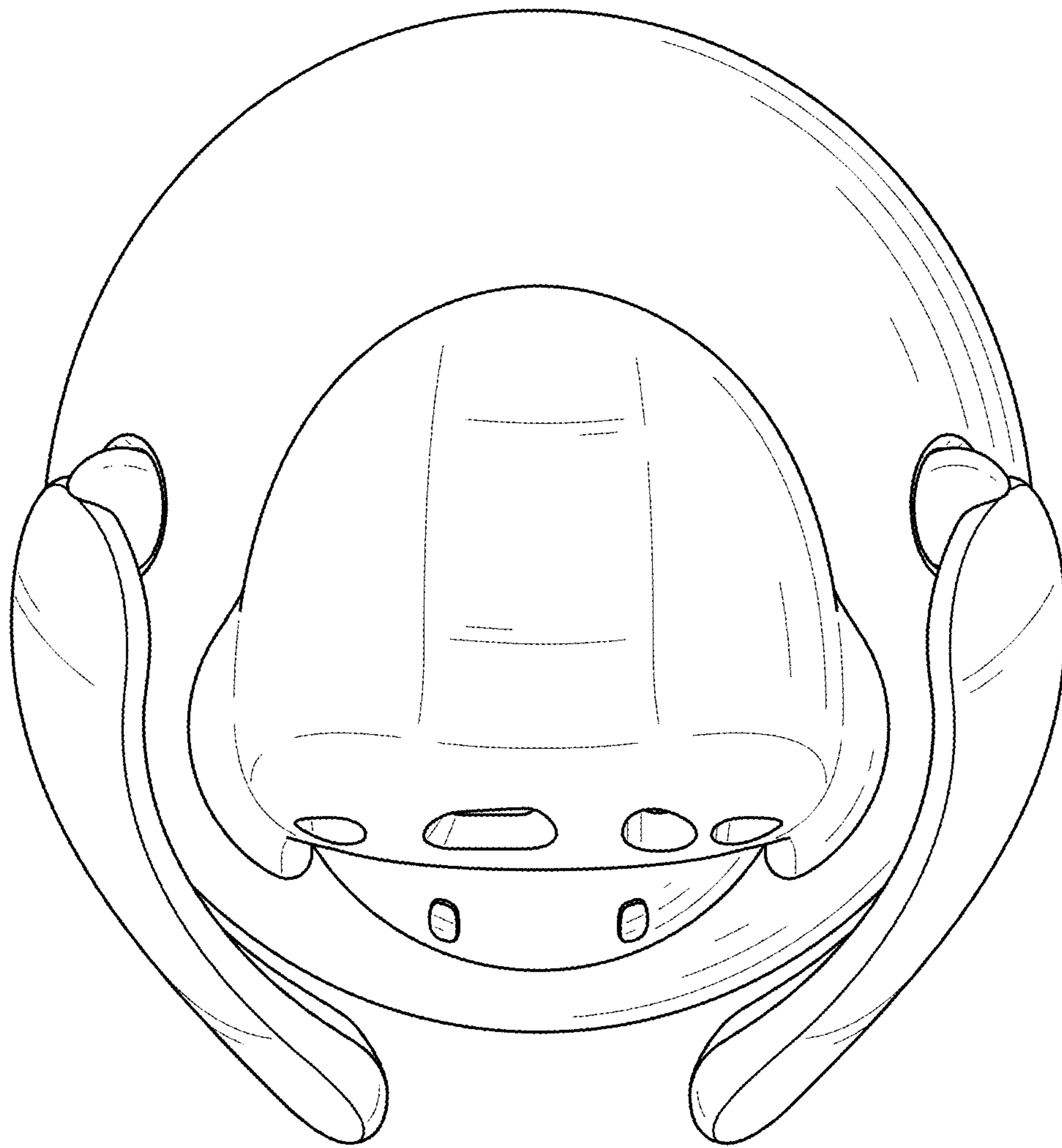

FIG. 6

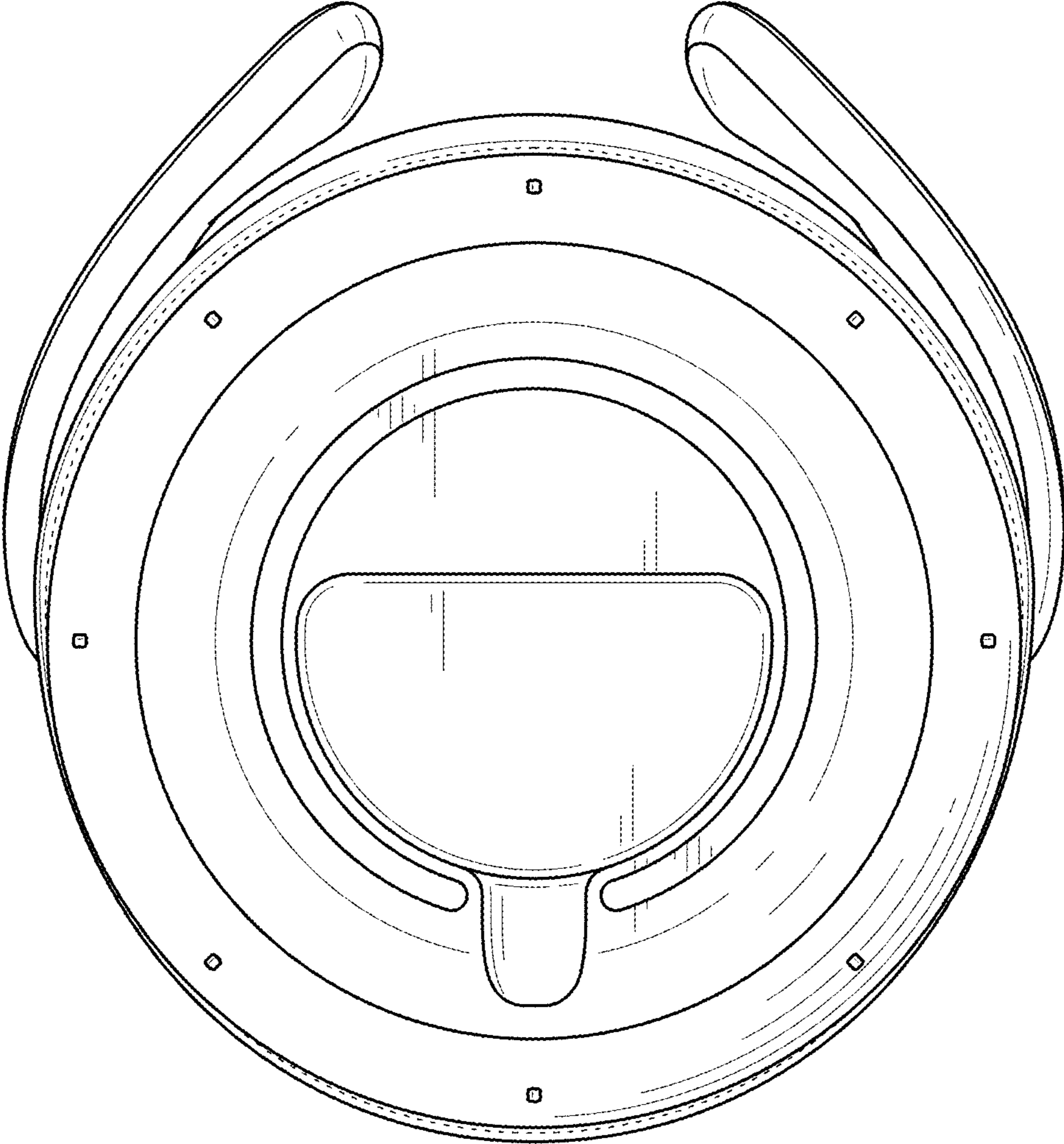

FIG. 7

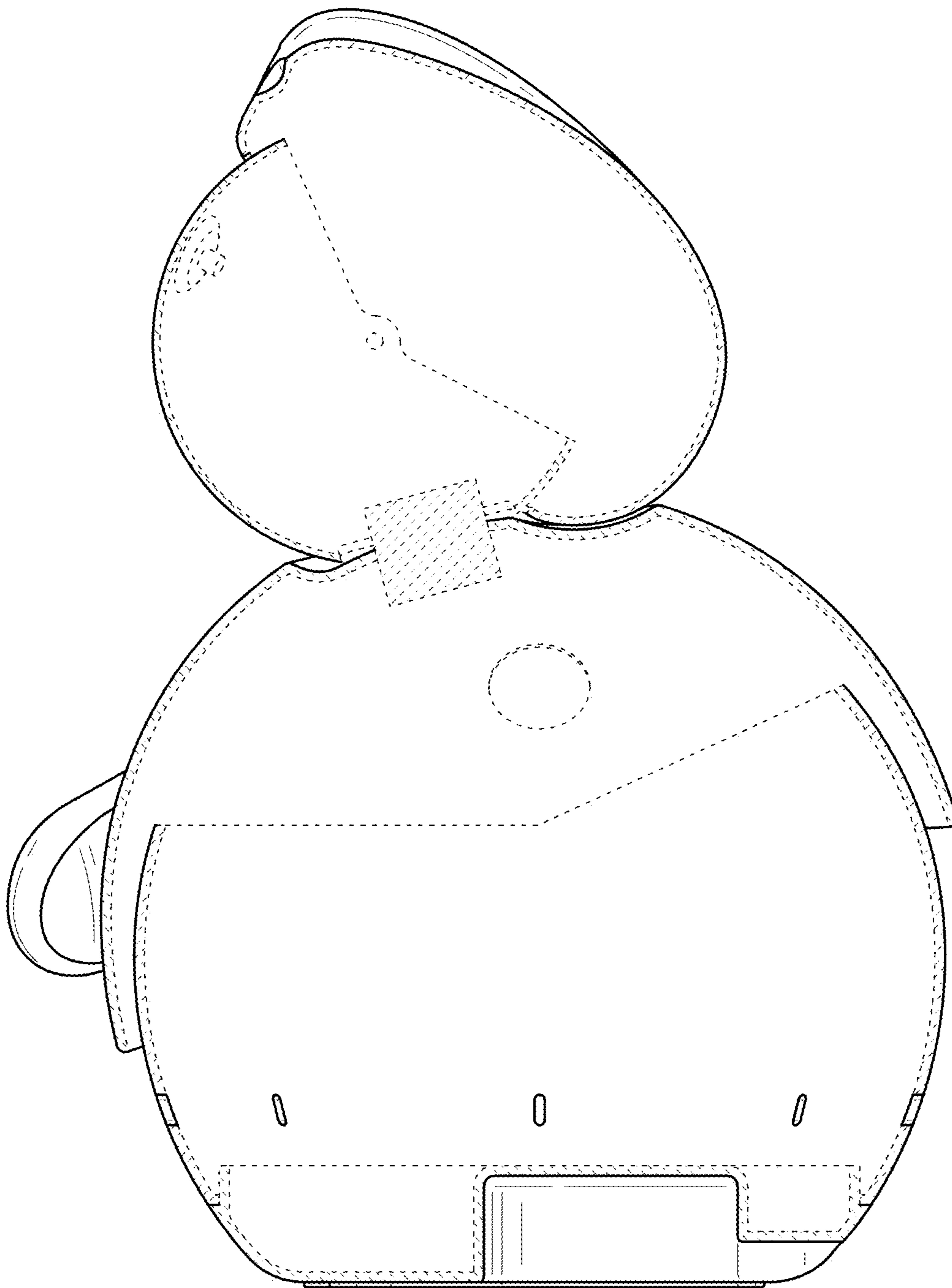

FIG. 8