



US00D879739S

(12) **United States Design Patent**  
**McWilliam**

(10) **Patent No.:** **US D879,739 S**  
(45) **Date of Patent:** **\*\* Mar. 31, 2020**

(54) **AUDIO RECEIVER DEVICE**

H04R 2499/13; H04R 2499/15; H04S  
3/00; H04S 7/30

(71) Applicant: **Amazon Technologies, Inc.**, Seattle,  
WA (US)

See application file for complete search history.

(72) Inventor: **Giles David Matthew McWilliam**, San  
Francisco, CA (US)

(56) **References Cited**

(73) Assignee: **Amazon Technologies, Inc.**, Seattle,  
WA (US)

U.S. PATENT DOCUMENTS

D213,050	S	*	12/1968	Hardy	.....	D14/185
D316,716	S	*	5/1991	Nagata	.....	D14/188
D538,255	S	*	3/2007	Matsuoka	.....	D14/157
D538,264	S	*	3/2007	Peersman	.....	D14/209.1
D550,646	S	*	9/2007	Kaneko	.....	D14/168

(Continued)

(\*\*) Term: **15 Years**

OTHER PUBLICATIONS

(21) Appl. No.: **29/663,046**

The Indian Office Action dated Apr. 11, 2019 for Indian Patent Application No. 315436-001, a counterpart of U.S. Appl. No. 29/663,044, 2 pages.

(22) Filed: **Sep. 11, 2018**

(51) **LOC (12) Cl.** ..... **14-03**

(Continued)

(52) **U.S. Cl.**  
USPC ..... **D14/188**

*Primary Examiner* — Katie Jane Stofko

(74) *Attorney, Agent, or Firm* — Lee & Hayes, P.C.

(58) **Field of Classification Search**  
USPC ..... D14/167, 168, 170–172, 187, 188,  
D14/194–196, 204, 207, 209.1, 210–216,  
D14/219, 221, 222, 224, 239, 496;  
181/143, 144, 147, 148, 150, 153, 157,  
181/198, 199; 381/300–303, 306, 332,  
381/333, 336, 345, 361–364, 386–388;  
369/6–12

(57) **CLAIM**

The ornamental design for an audio receiver device, as shown and described.

CPC ..... B60R 11/0217; G06F 1/1688; G10K 9/22;  
G10K 11/004; H03F 1/327; H04M 1/03;  
H04M 1/035; H04N 5/642; H04N  
21/4852; H04R 1/02; H04R 1/06; H04R  
1/021; H04R 1/025; H04R 1/026; H04R  
1/028; H04R 1/105; H04R 1/323; H04R  
1/403; H04R 1/2803; H04R 1/2834;  
H04R 5/02; H04R 7/20; H04R 9/06;  
H04R 9/025; H04R 2201/021; H04R  
2400/00; H04R 2400/07; H04R 2499/11;

**DESCRIPTION**

FIG. 1 is a top perspective view of a first embodiment of an audio receiver device;  
FIG. 2 is a front view thereof;  
FIG. 3 is a back view thereof;  
FIG. 4 is a left-side view thereof;  
FIG. 5 is a right-side view thereof;  
FIG. 6 is a top view thereof;  
FIG. 7 is a bottom view thereof;  
FIG. 8 is a top perspective view of a second embodiment of an audio receiver device;  
FIG. 9 is a front view thereof;  
FIG. 10 is a back view thereof;  
FIG. 11 is a left-side view thereof;  
FIG. 12 is a right-side view thereof;

(Continued)

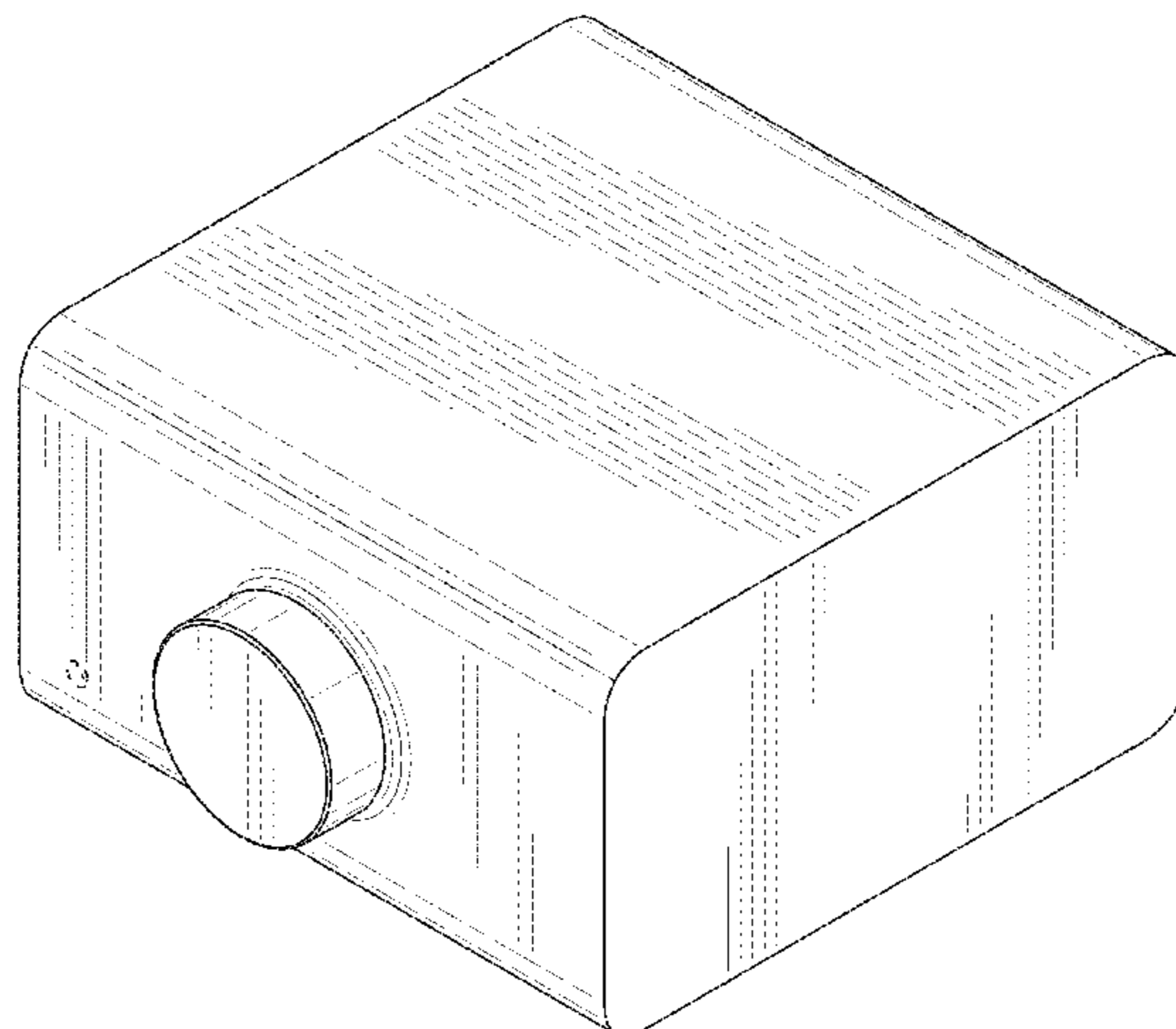

FIG. 13 is a top view thereof; and,  
FIG. 14 is a bottom view thereof.  
The dashed broken lines depict portions of the audio receiver device which form no part of the claimed design.

**1 Claim, 14 Drawing Sheets**

(56)

**References Cited**

U.S. PATENT DOCUMENTS

D563,403 S *	3/2008	Files .....	D14/188
D571,350 S *	6/2008	Iwamoto .....	D14/157
D572,232 S *	7/2008	Joseph .....	D14/188
D579,441 S *	10/2008	Okamura .....	D14/168
D669,992 S *	10/2012	Schafer .....	D24/170
D690,280 S *	9/2013	Schul .....	D14/168
D746,254 S *	12/2015	Ito .....	D14/188
D836,088 S *	12/2018	Ivey .....	D14/215

OTHER PUBLICATIONS

The Indian Office Action dated Mar. 28, 2019 for Indian Patent Application No. 315437-001, a counterpart of U.S. Appl. No. 29/663,046, 2 pages.

\* cited by examiner

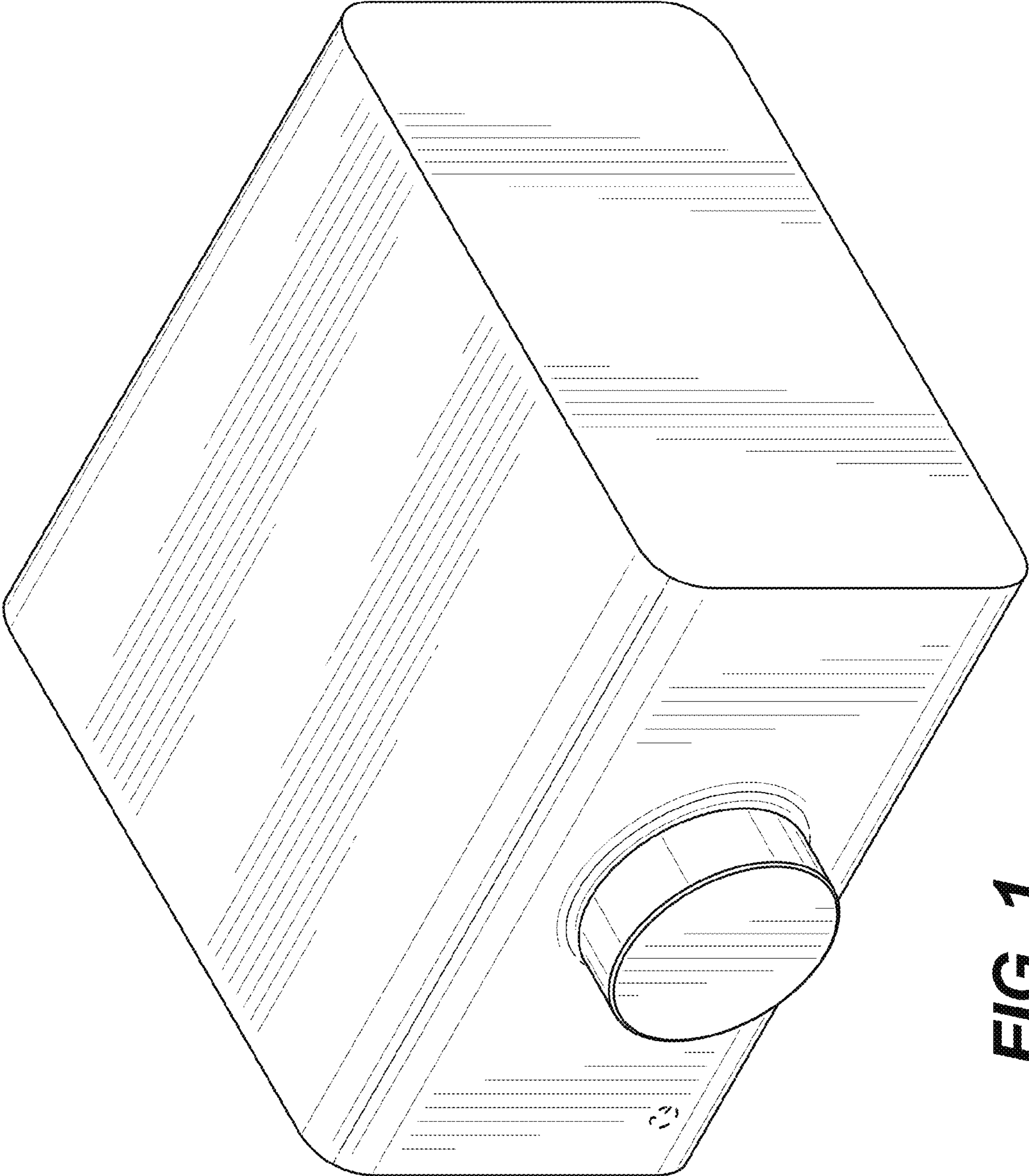
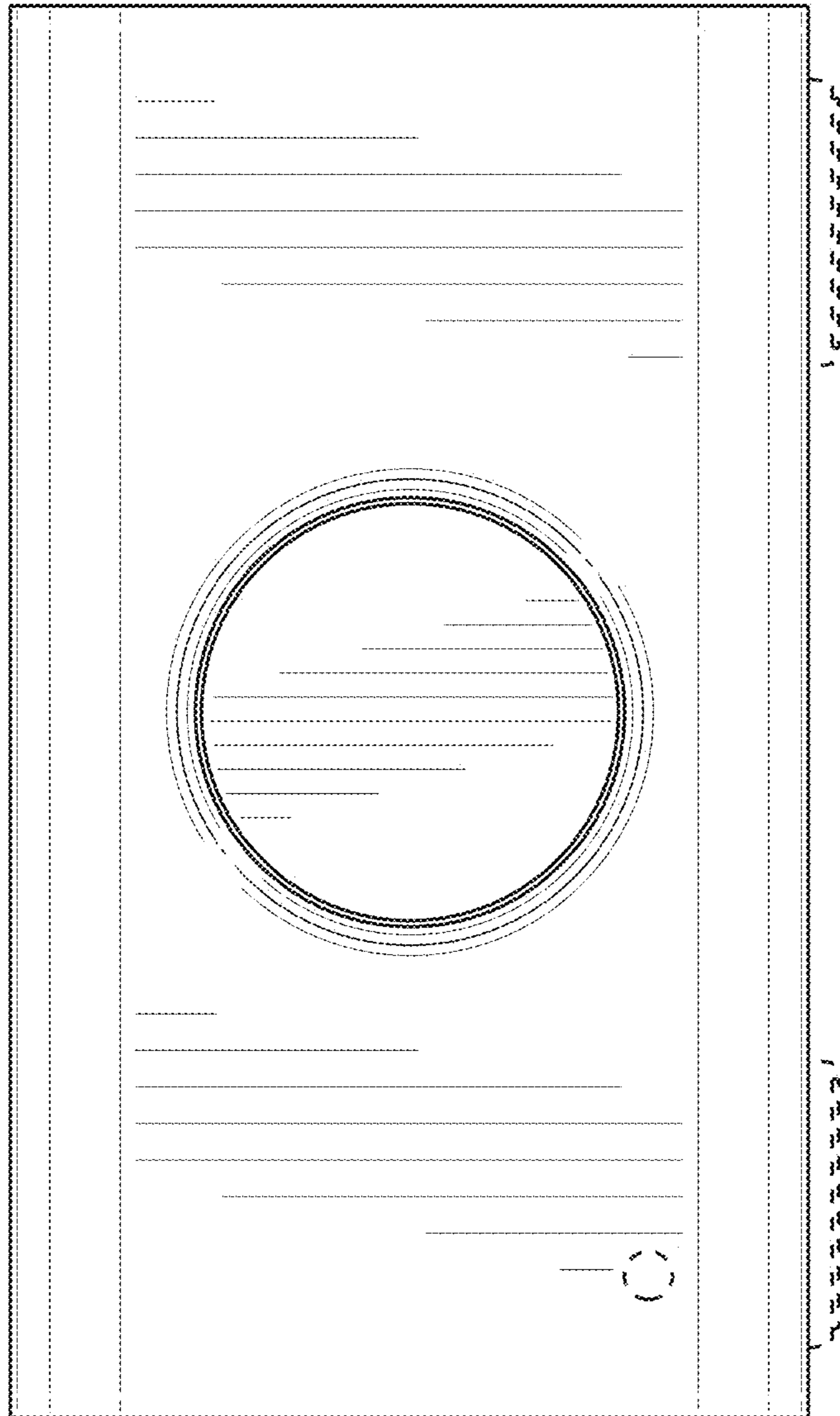
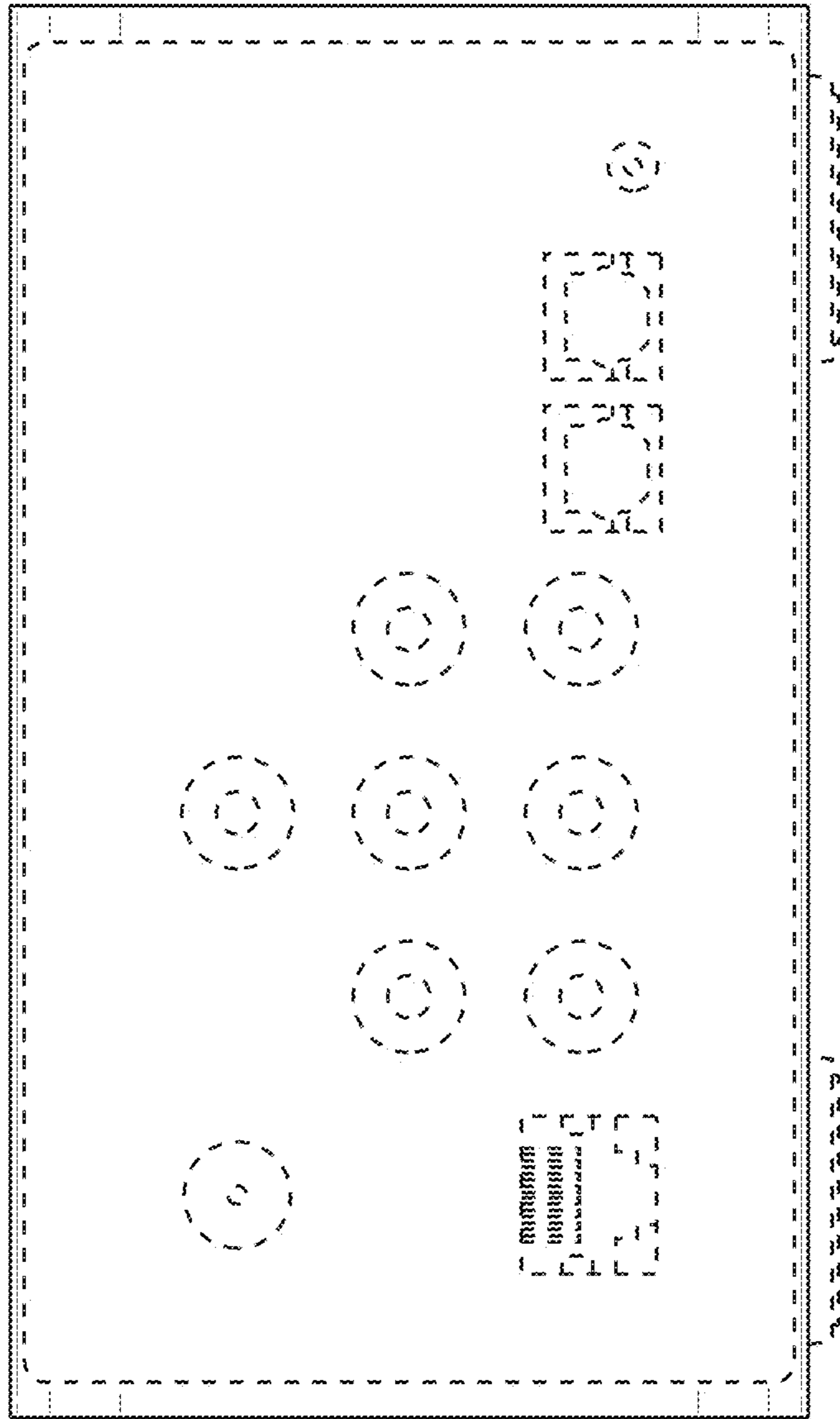

FIG. 1



**FIG. 2**



**FIG. 3**

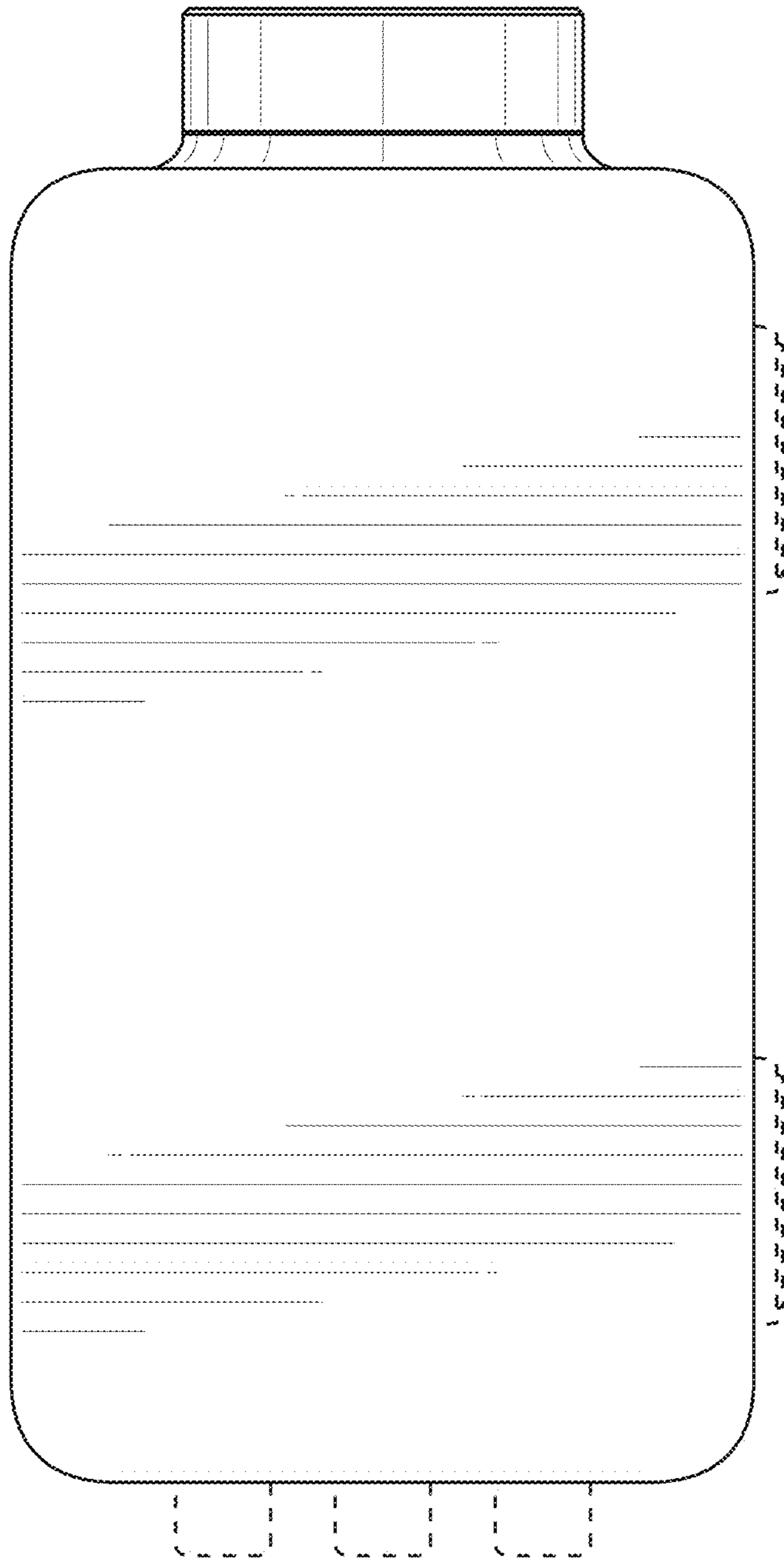

**FIG. 4**

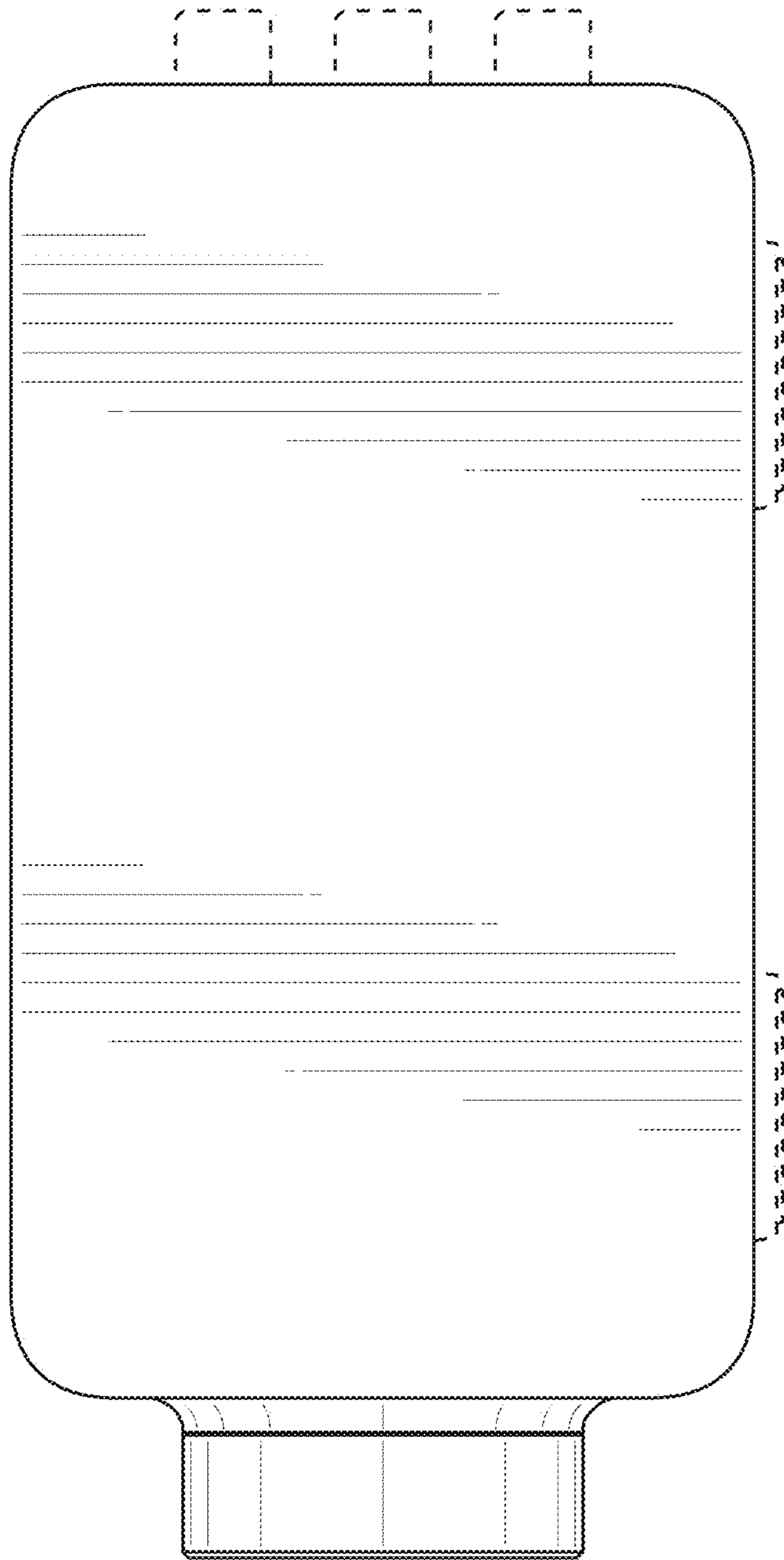

**FIG. 5**

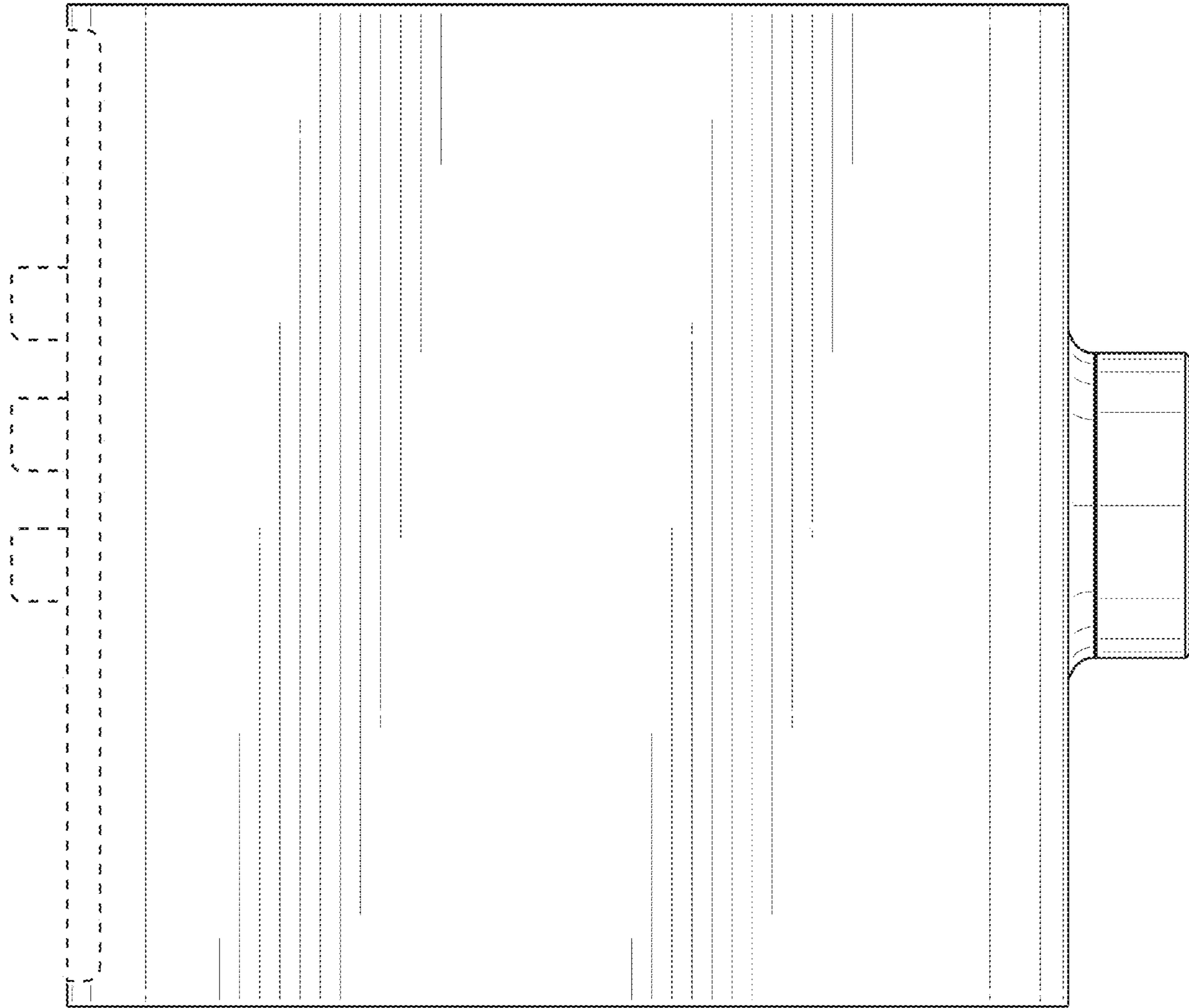

**FIG. 6**



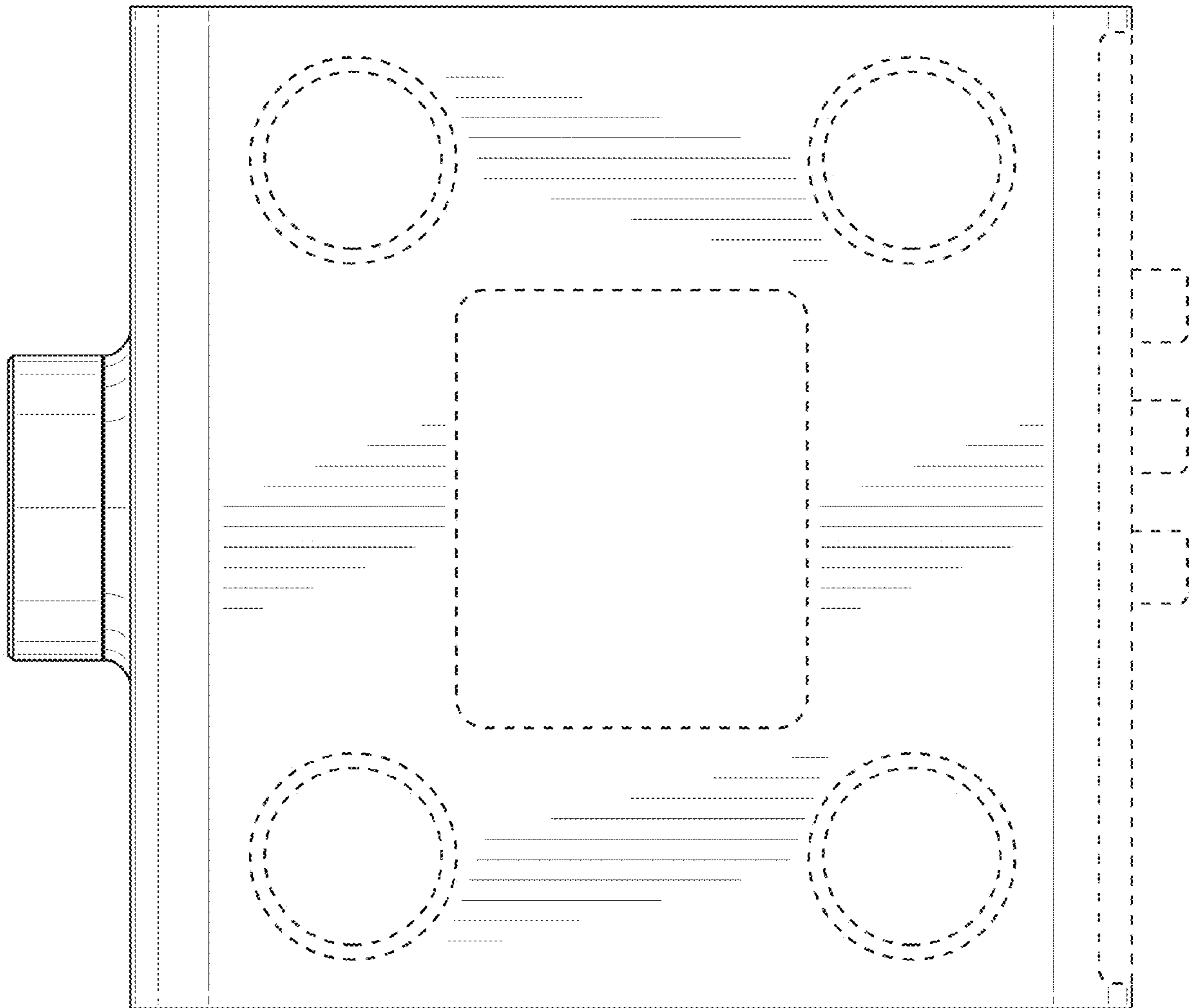
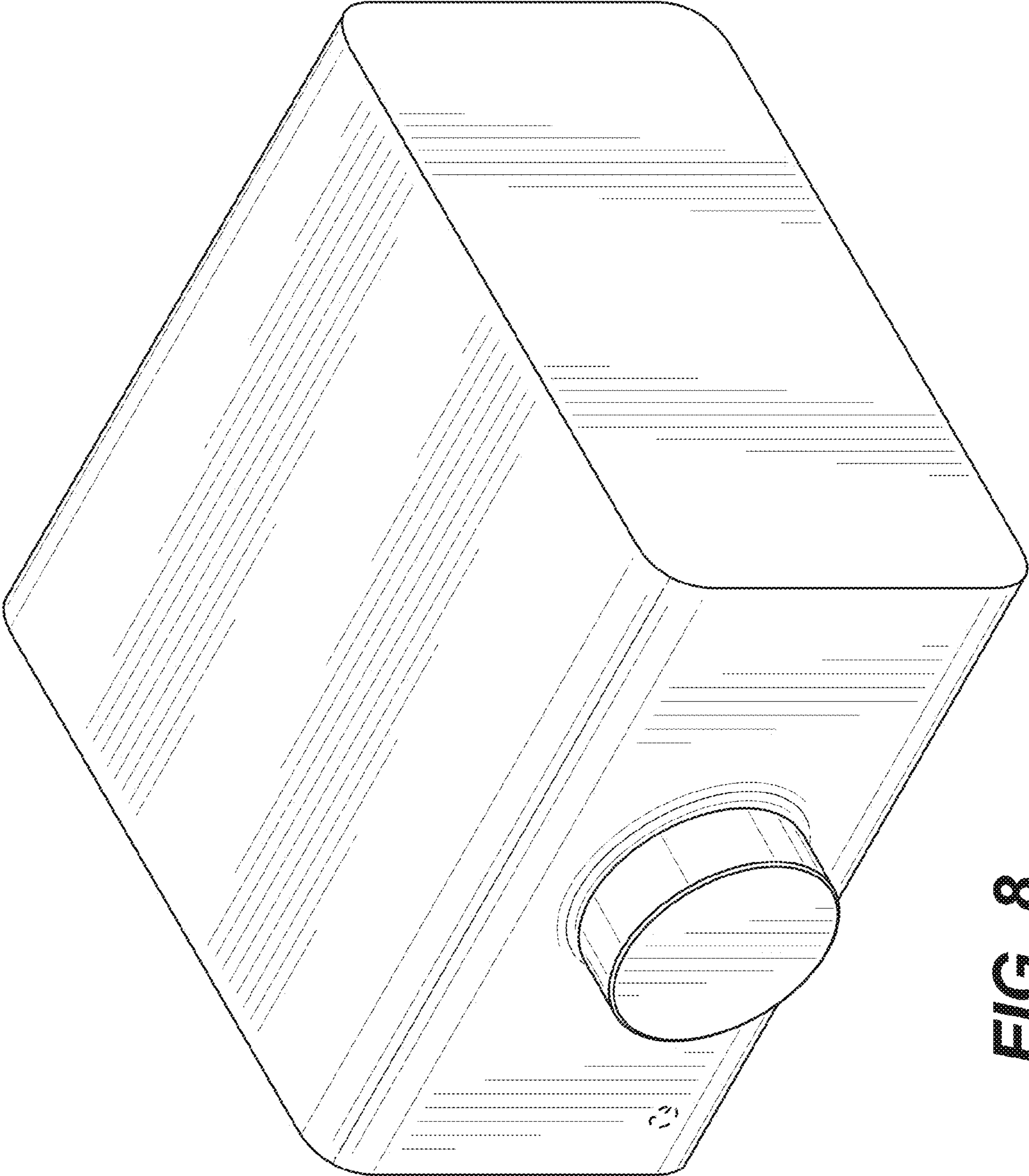
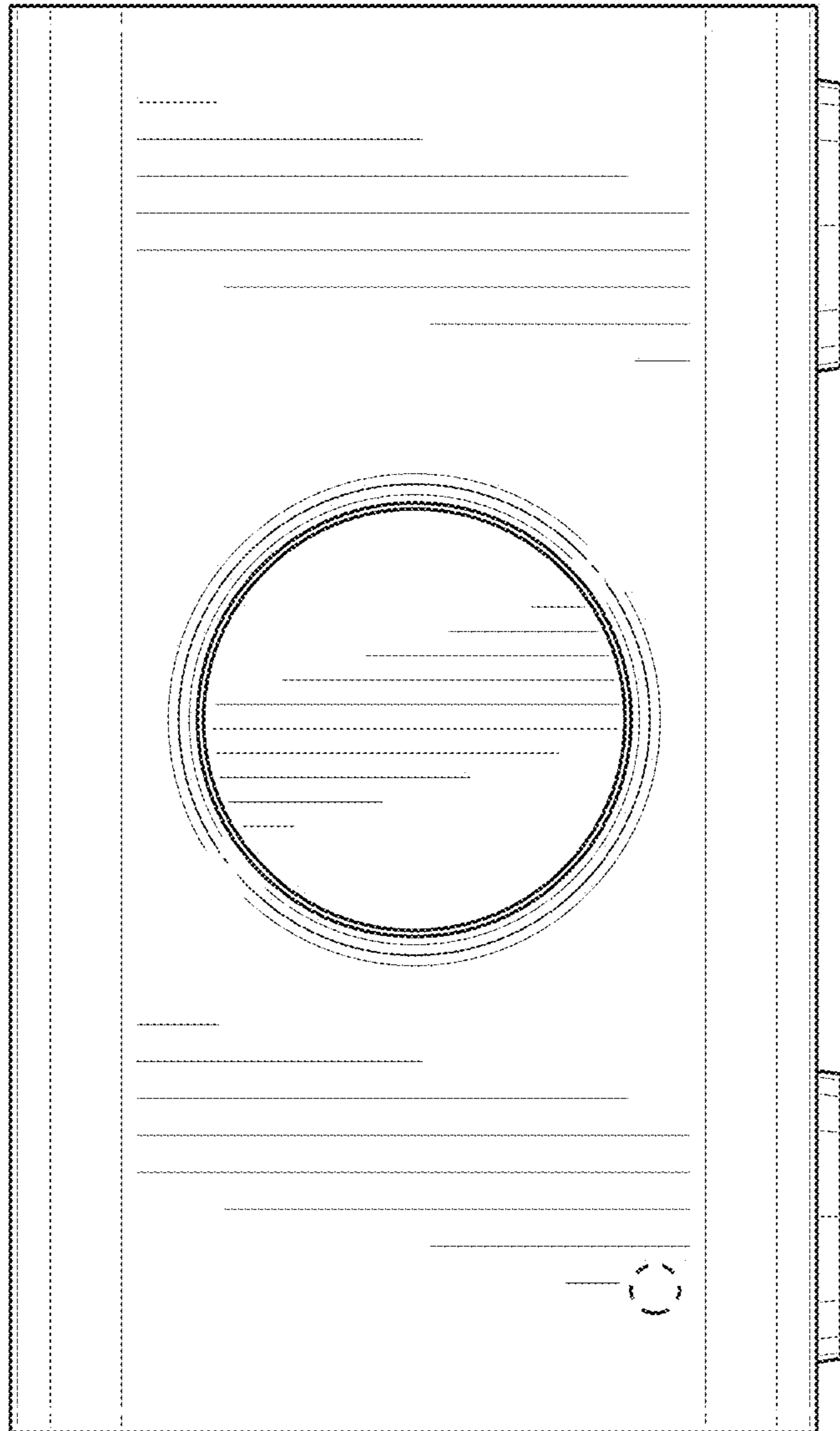

FIG. 7



**FIG. 8**



**FIG. 9**

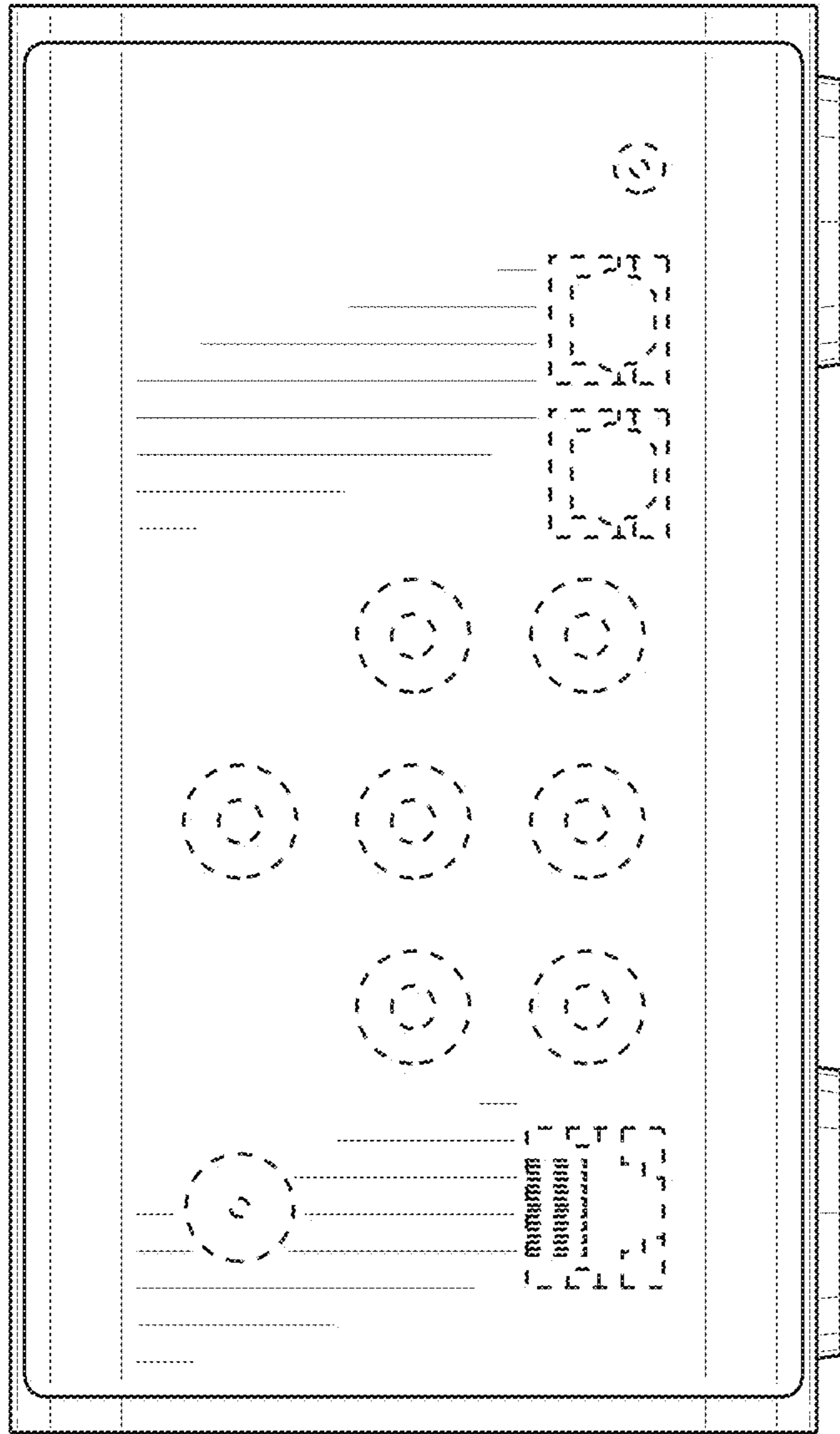

**FIG. 10**

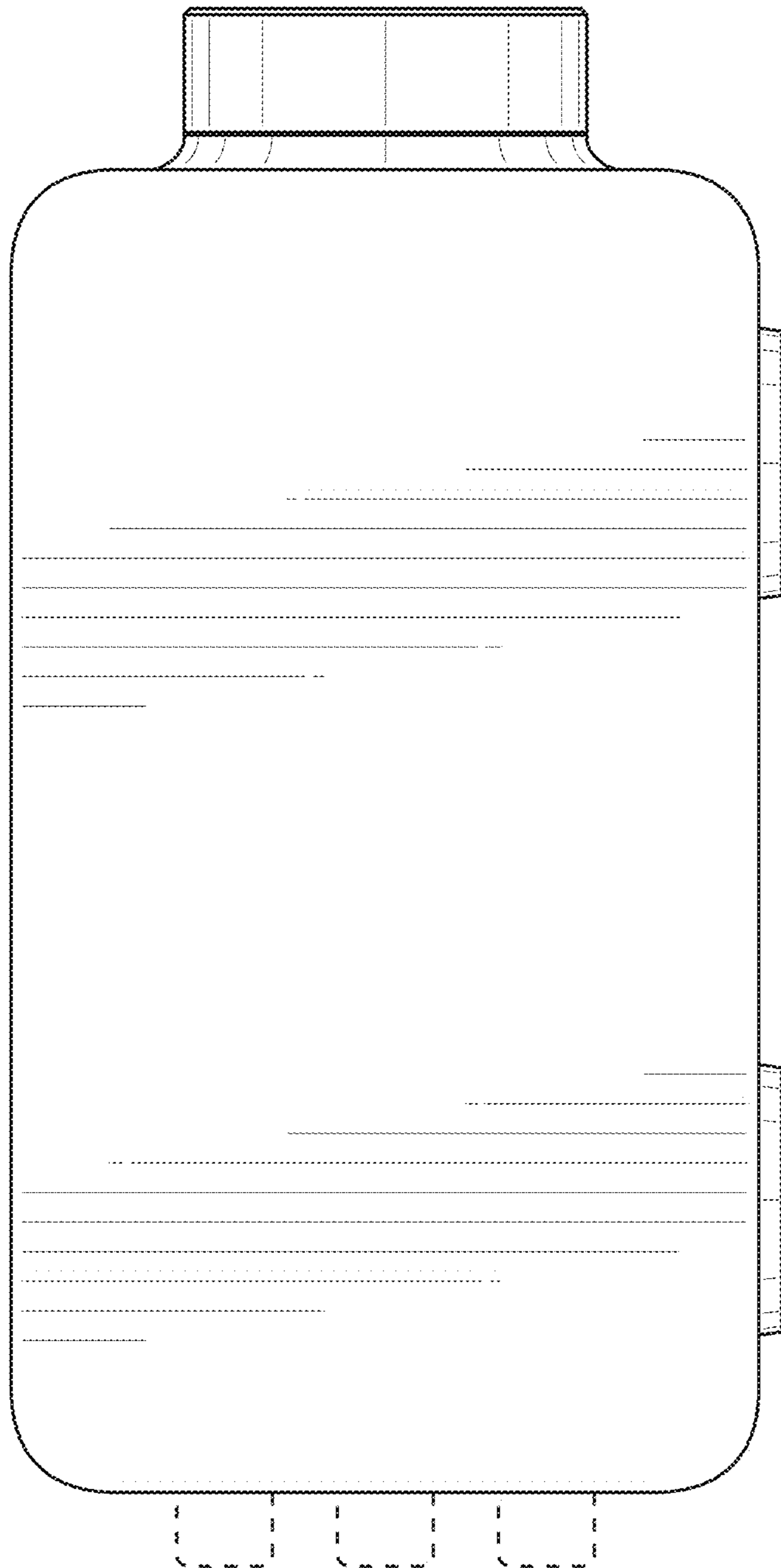

**FIG. 11**

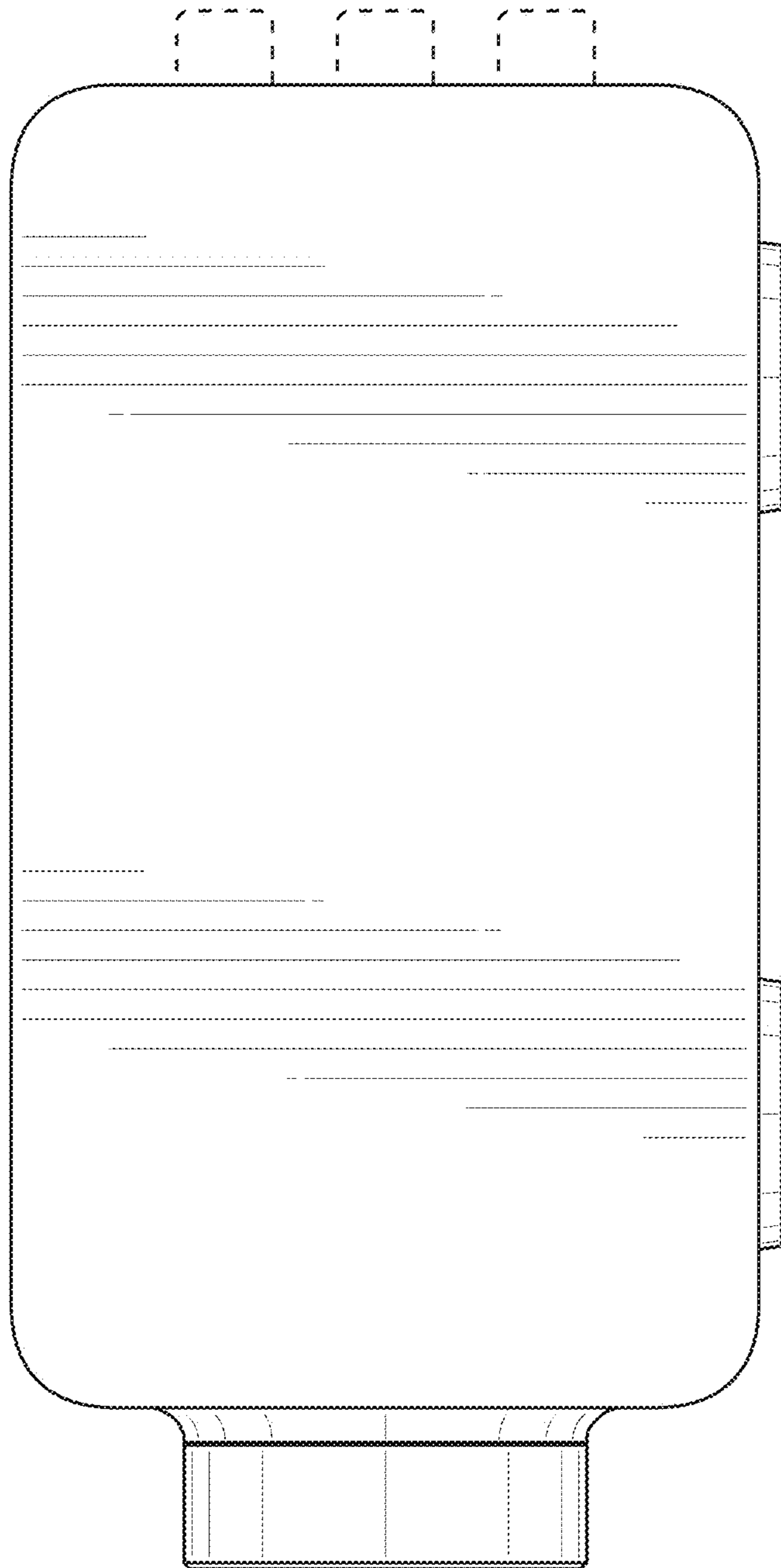

**FIG. 12**

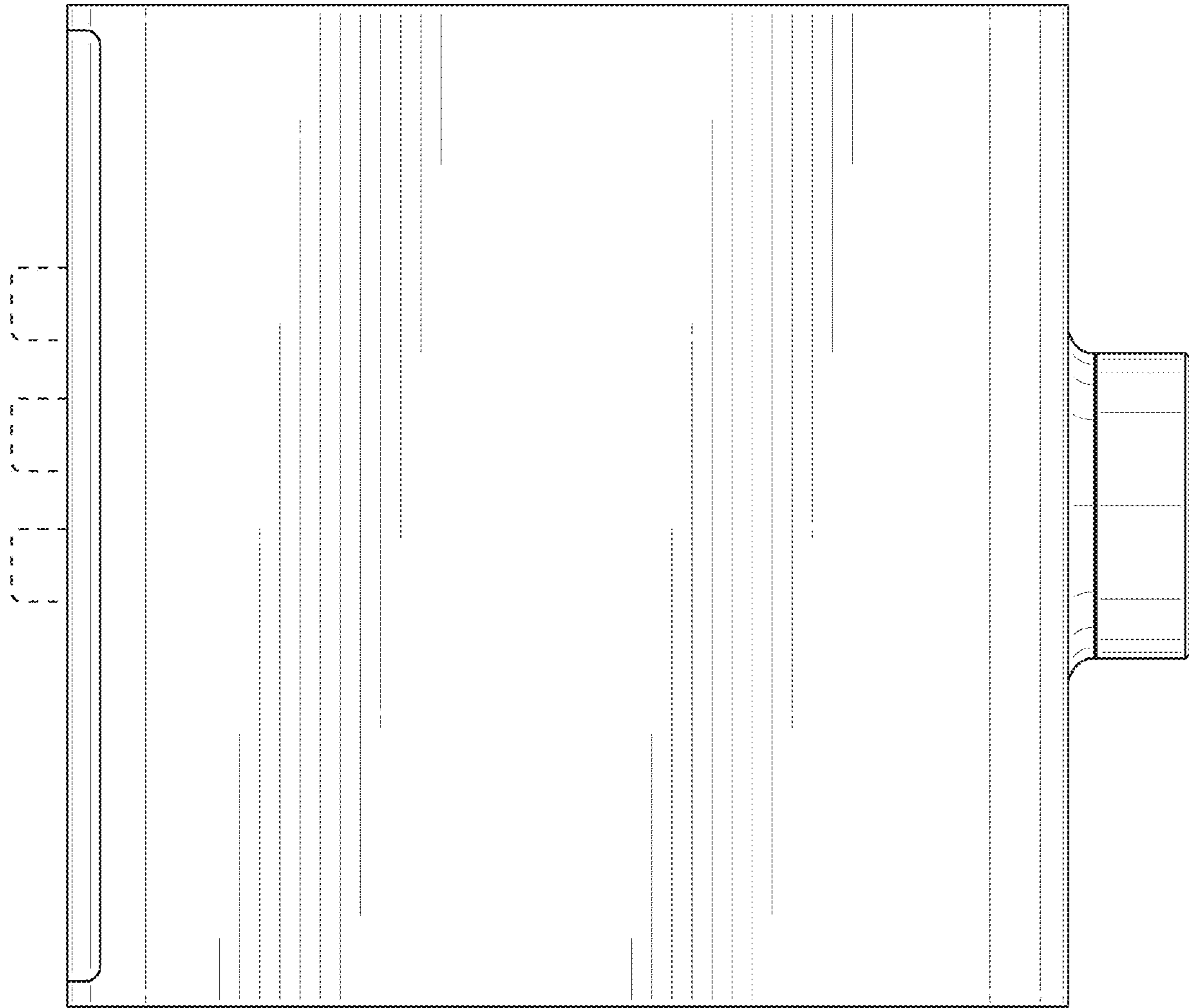

**FIG. 13**

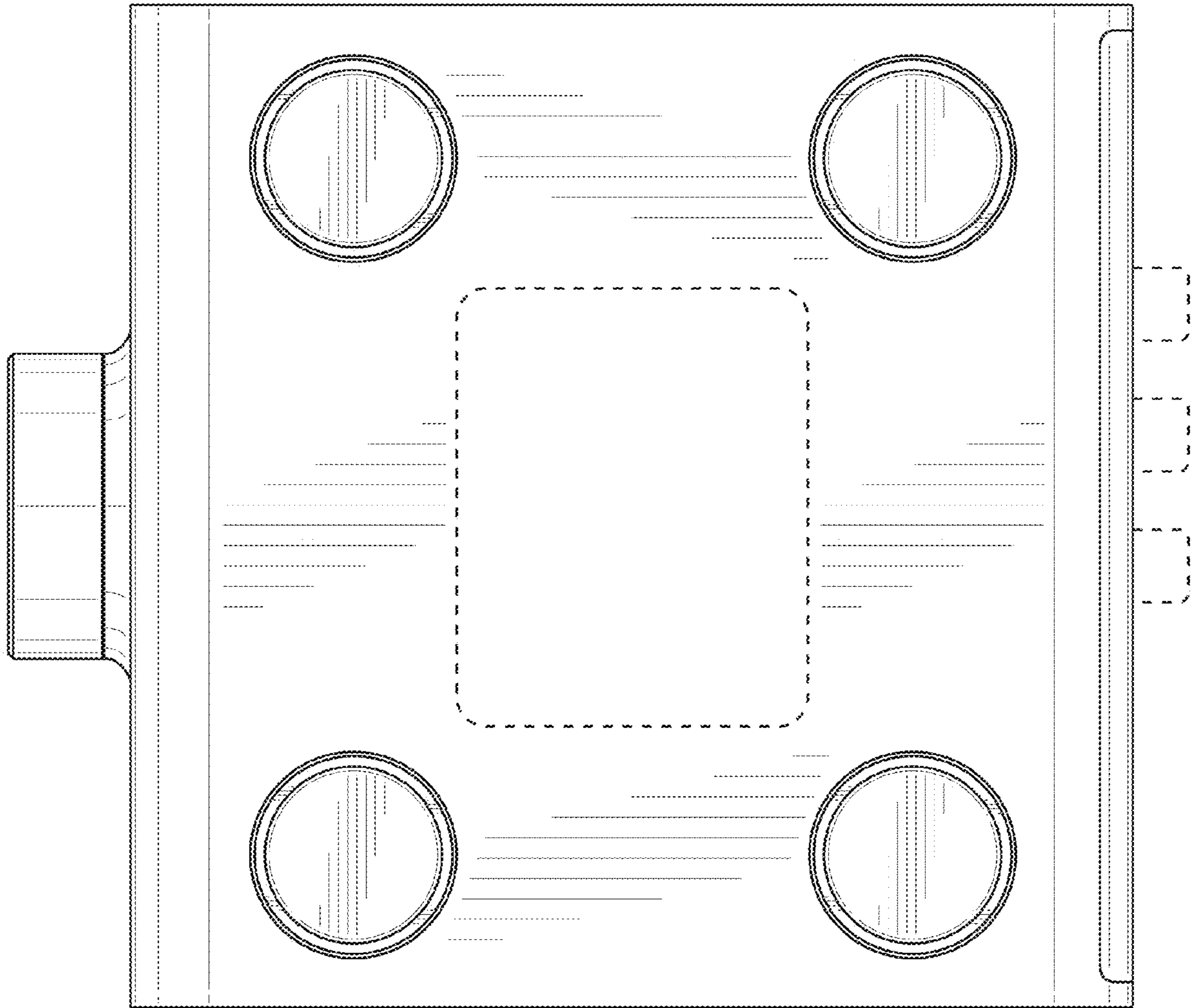

**FIG. 14**