



US00D879682S

(12) **United States Design Patent** (10) **Patent No.:** **US D879,682 S**
Melville-Brown (45) **Date of Patent:** **** Mar. 31, 2020**

(54) **REAR BUMPER**

(71) Applicant: **HONDA MOTOR CO., LTD.**, Tokyo (JP)

(72) Inventor: **Guy Thomas Melville-Brown**, Manhattan Beach, CA (US)

(73) Assignee: **HONDA MOTOR CO., LTD.**, Tokyo (JP)

(**) Term: **15 Years**

(21) Appl. No.: **29/654,787**

(22) Filed: **Jun. 27, 2018**

(51) **LOC (12) Cl.** **12-16**

(52) **U.S. Cl.**
USPC **D12/169**

(58) **Field of Classification Search**
USPC D12/169, 86, 90-92; 293/102, 113, 115, 293/117, 120; 296/180.1, 180.2
CPC B60R 19/02; B60R 19/04; B62D 25/08
See application file for complete search history.

(56) **References Cited**

U.S. PATENT DOCUMENTS

D729,138 S	5/2015	Davidson et al.	
D746,737 S *	1/2016	Wolff	D12/169
D752,484 S	3/2016	Davidson et al.	
D759,540 S	6/2016	Davidson et al.	
D760,628 S	7/2016	Davidson et al.	
D761,457 S	7/2016	Davidson et al.	
D764,083 S	8/2016	Davidson et al.	
D767,467 S	9/2016	Davidson et al.	
D772,117 S	11/2016	Davidson et al.	
D774,427 S	12/2016	Davidson et al.	
D774,428 S	12/2016	Davidson et al.	
D811,289 S *	2/2018	Bucher	D12/169
D813,748 S *	3/2018	Kim	D12/169
D813,749 S *	3/2018	Bucher	D12/169
D813,755 S *	3/2018	Loeb	D12/169

(Continued)

OTHER PUBLICATIONS

“2018 Honda Pilot—The Modern Midsize Family Suv,” Honda Motor, Co., <https://automobiles.honda.com/pilot>, accessed Jun. 18, 2018.

Primary Examiner — Melody N Brown

(74) *Attorney, Agent, or Firm* — Arent Fox LLP

(57) **CLAIM**

The ornamental design for a rear bumper, as shown and described.

DESCRIPTION

FIG. 1 is a right, front perspective view of a rear bumper showing my new design;
FIG. 2 is a left, front perspective view thereof;
FIG. 3 is a left, rear perspective view thereof;
FIG. 4 is a right, rear perspective view thereof;
FIG. 5 is a front elevational view thereof;
FIG. 6 is a rear elevational view thereof;
FIG. 7 is a left side elevational view thereof;
FIG. 8 is a right side elevational view thereof;
FIG. 9 is a bottom plan view thereof;
FIG. 10 is a top plan view thereof;
FIG. 11 is a right, front perspective view of a rear bumper showing a second embodiment of my new design;
FIG. 12 is a left, front perspective view of FIG. 11;
FIG. 13 is a left, rear perspective view of FIG. 11;
FIG. 14 is a right, rear perspective view of FIG. 11;
FIG. 15 is a front elevational view of FIG. 11;
FIG. 16 is a rear elevational view of FIG. 11;
FIG. 17 is a left side elevational view of FIG. 11;
FIG. 18 is a right side elevational view of FIG. 11;
FIG. 19 is a bottom plan view of FIG. 11; and,
FIG. 20 is a top plan view of FIG. 11.

The broken lines shown in the figures are included for the purpose of illustrating portions of the rear bumper and form no part of the claimed design.

1 Claim, 20 Drawing Sheets

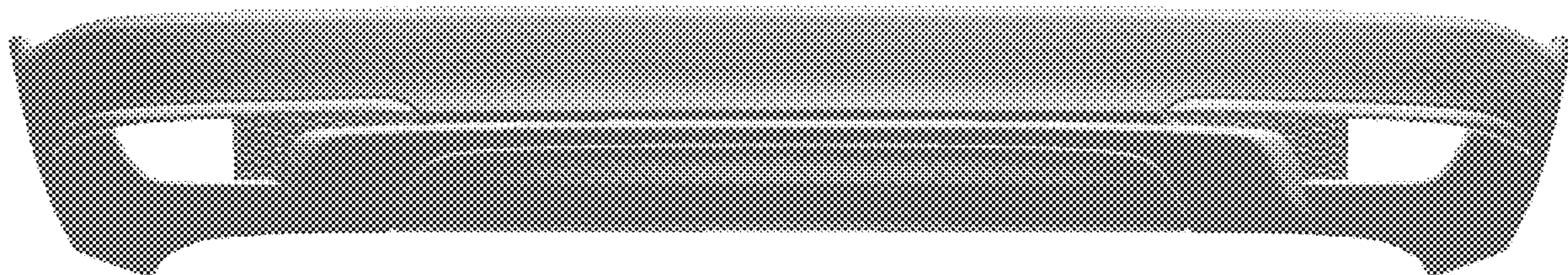

(56)

References Cited

U.S. PATENT DOCUMENTS

D821,950 S	*	7/2018	Kozub	D12/196
D842,777 S	*	3/2019	Austin	D12/169
D844,584 S	*	4/2019	Wheel	D12/169

* cited by examiner



FIG. 1

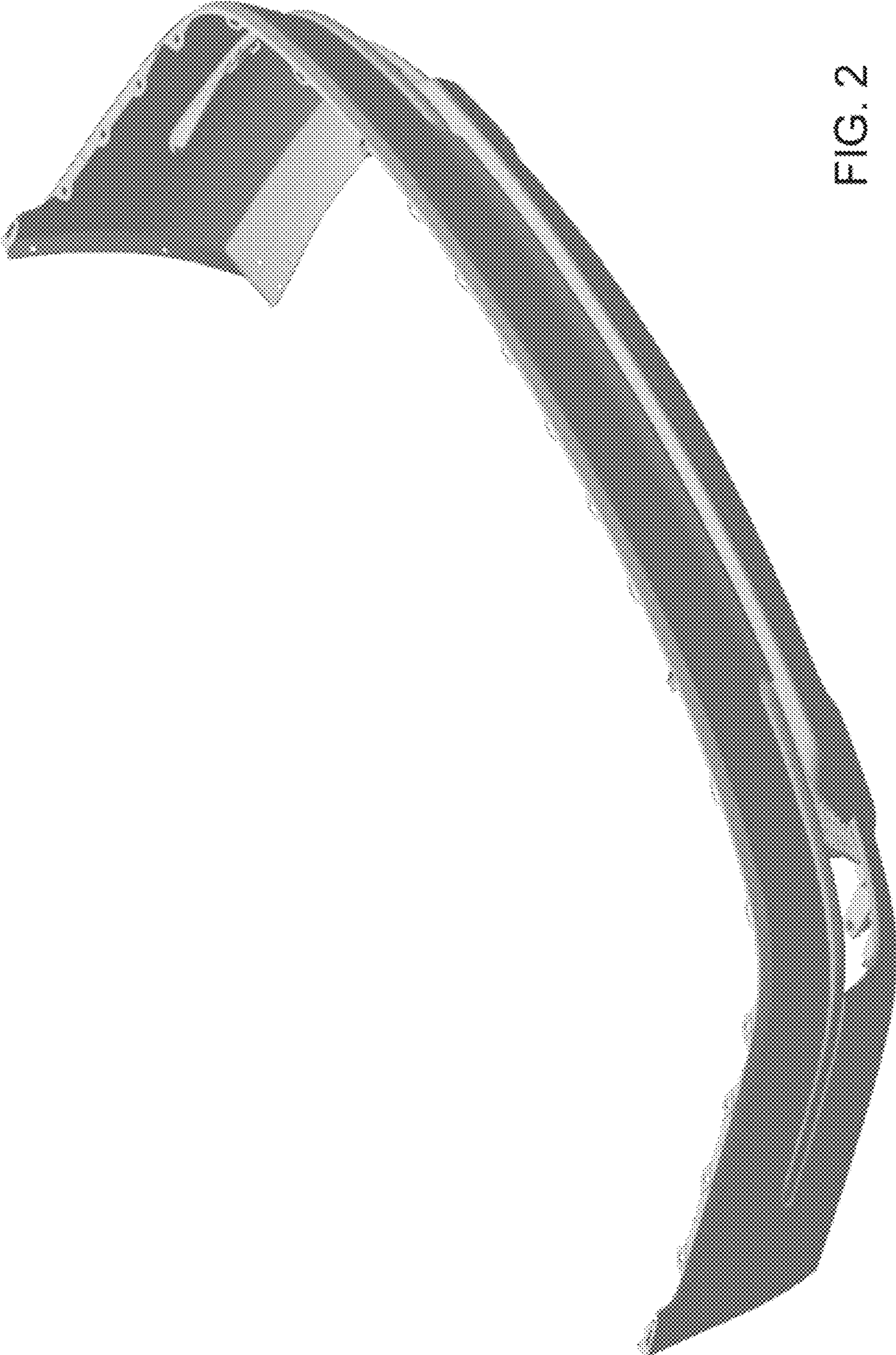

FIG. 2

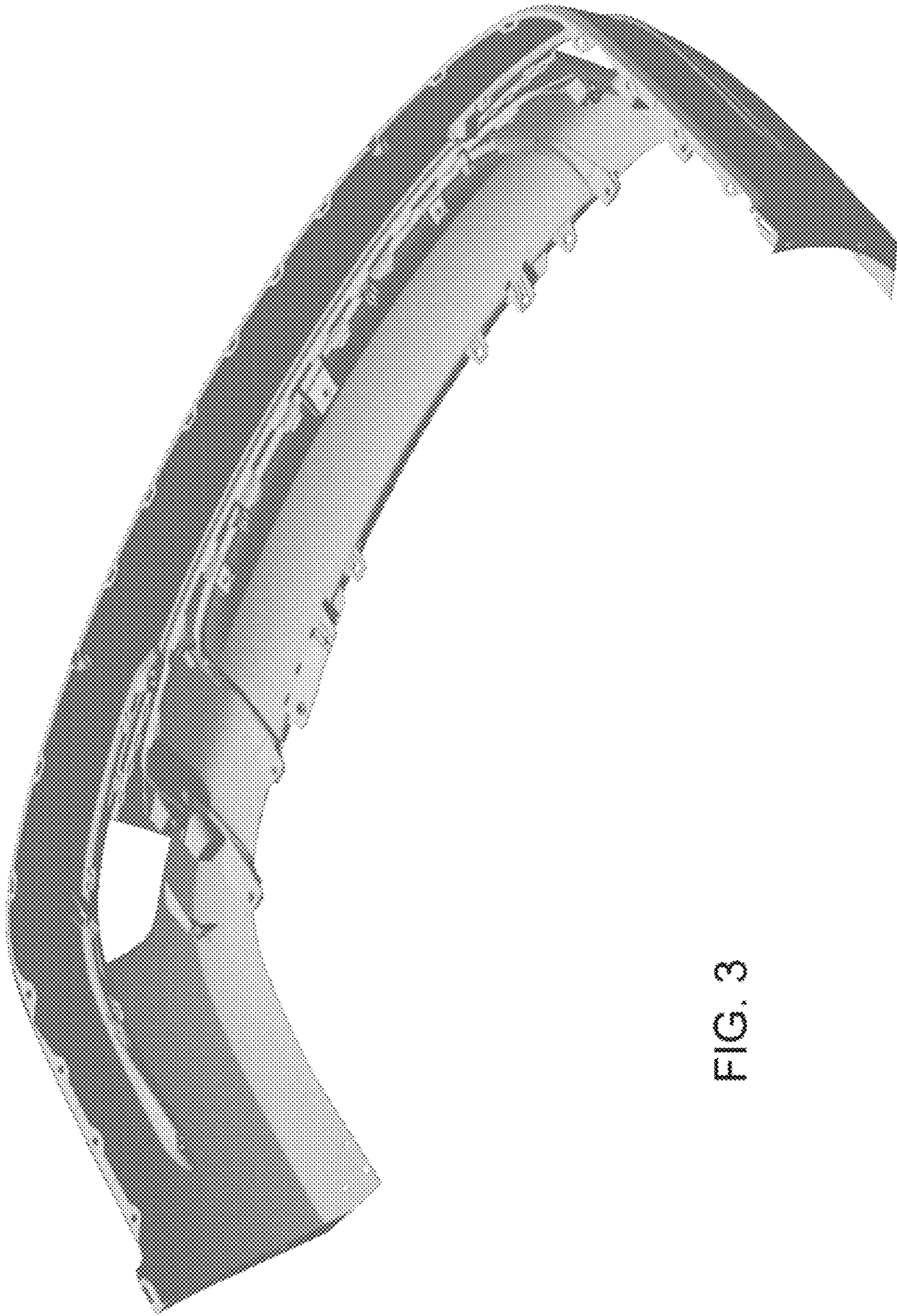

FIG. 3

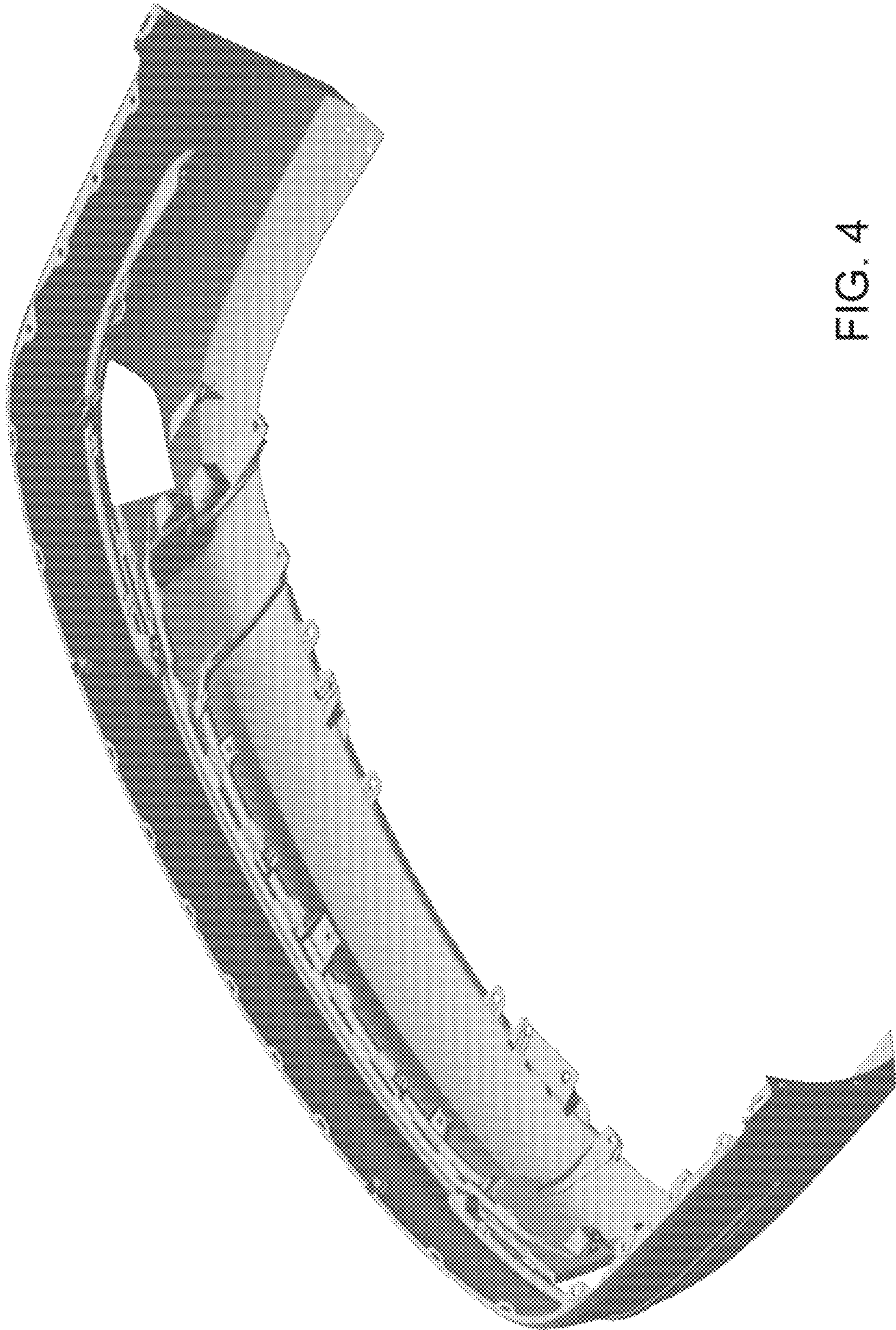

FIG. 4

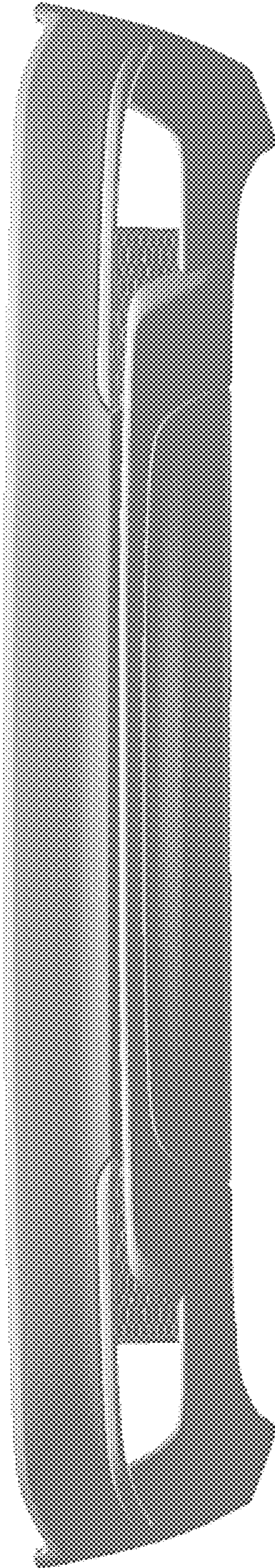

FIG. 5

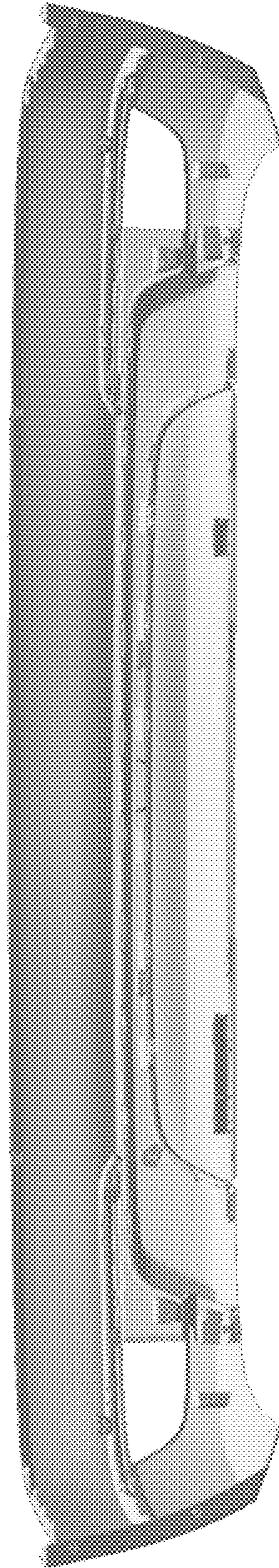

FIG. 6

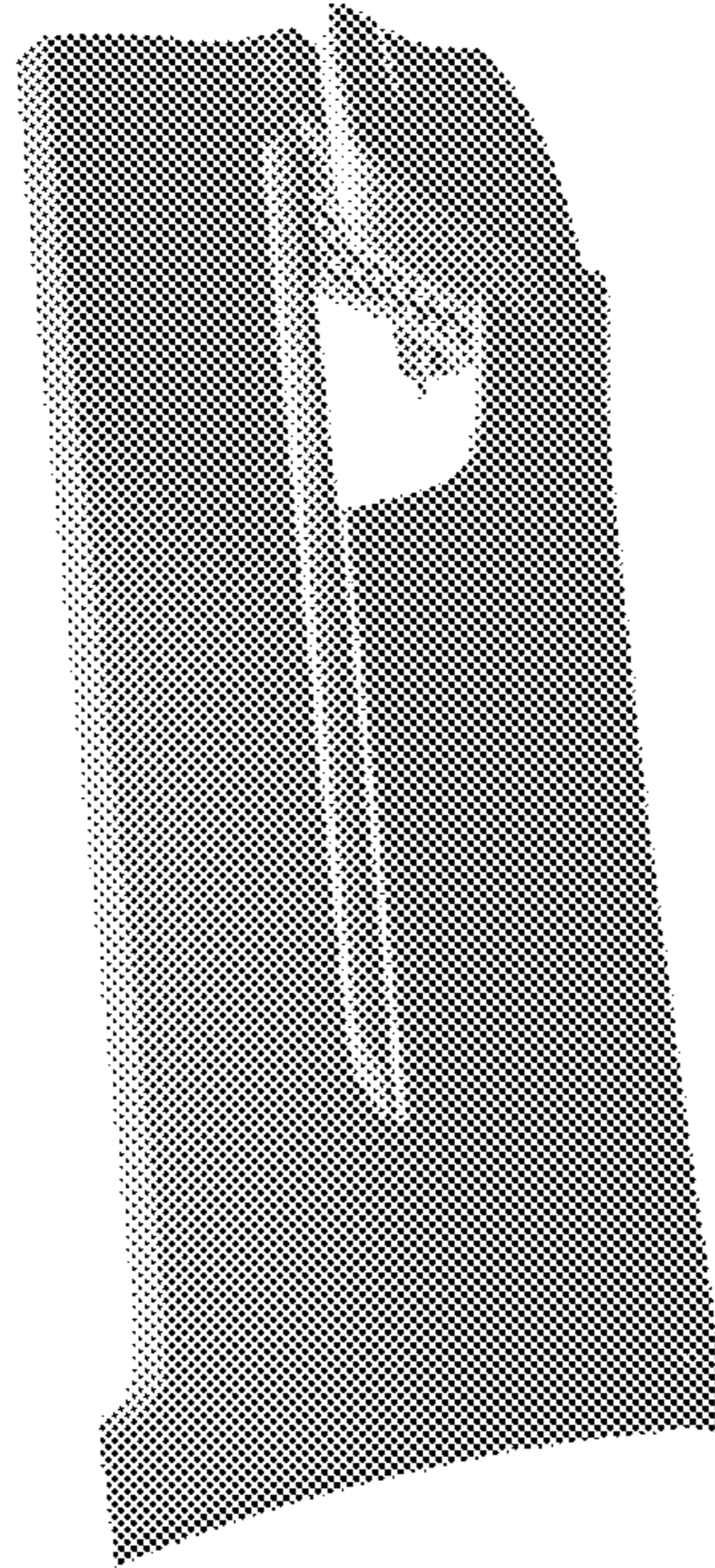

FIG. 7

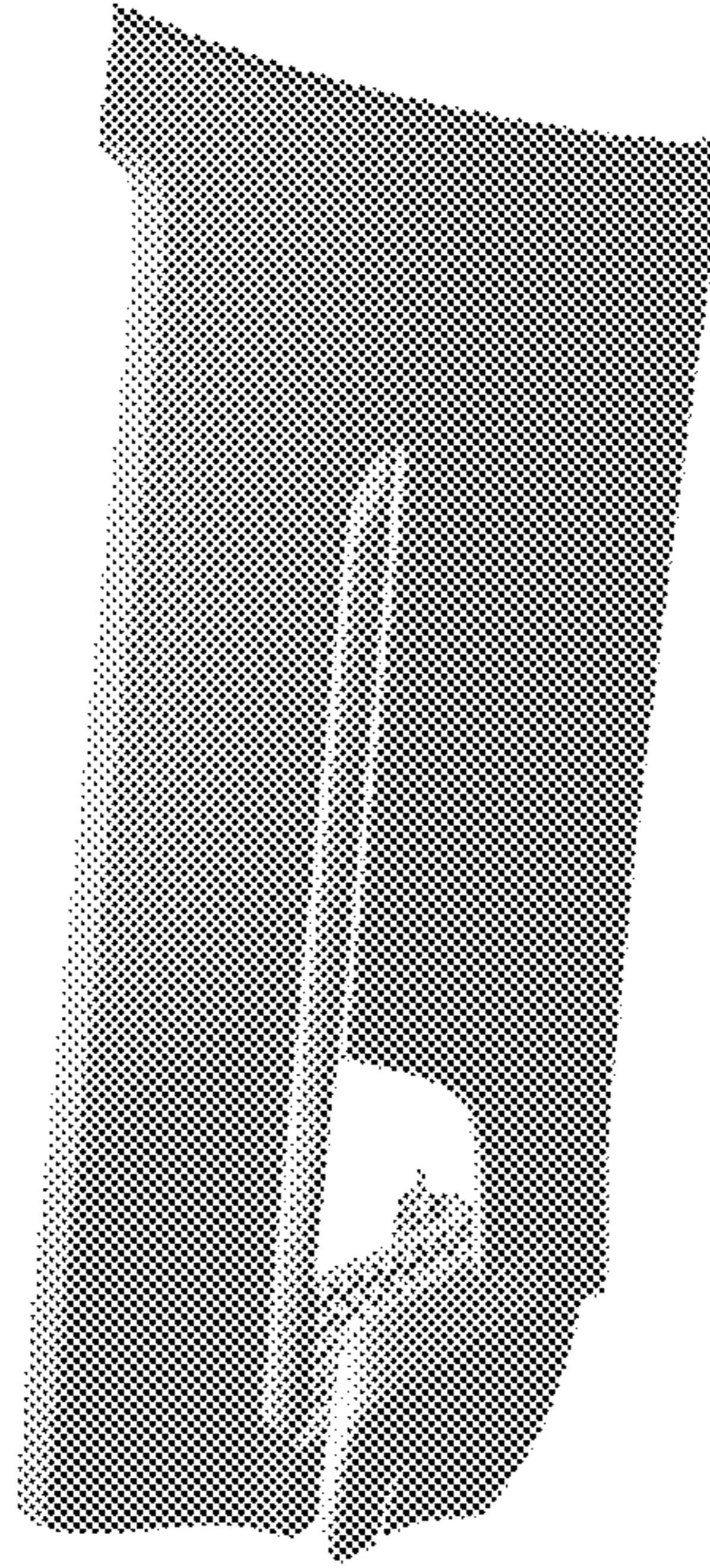

FIG. 8

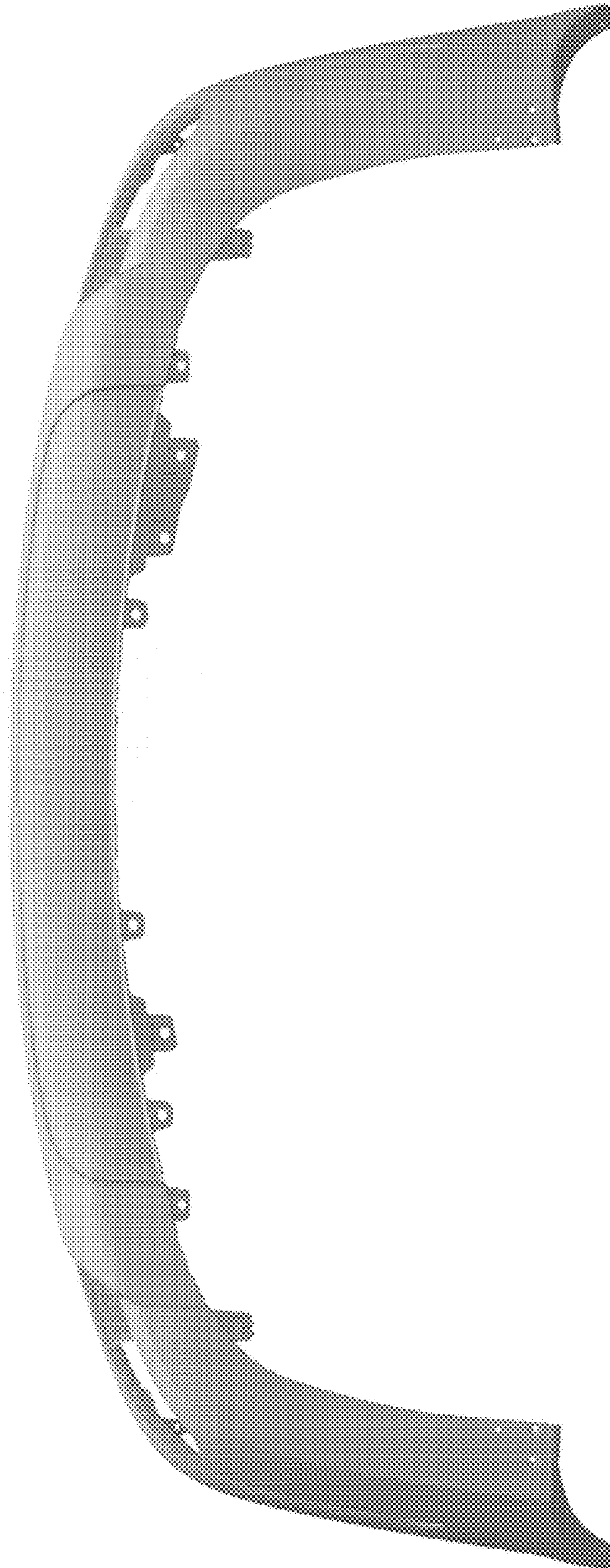

FIG. 9

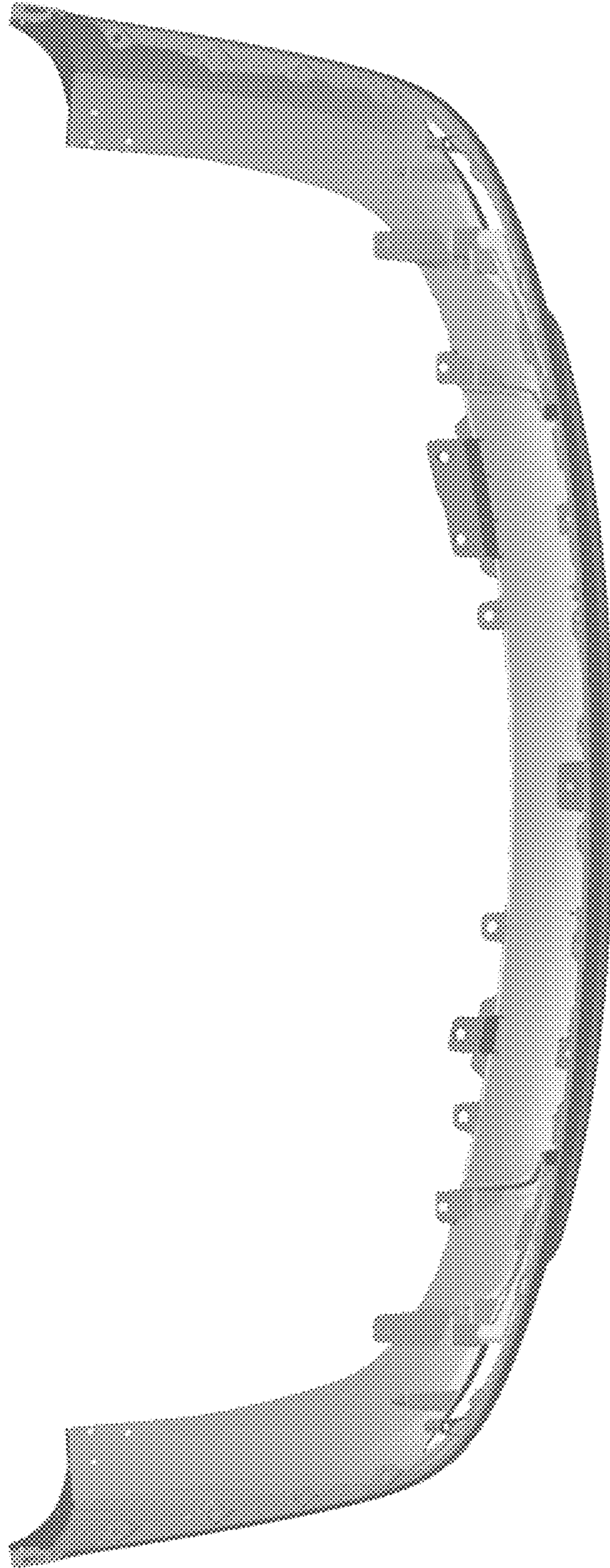

FIG. 10



FIG. 11

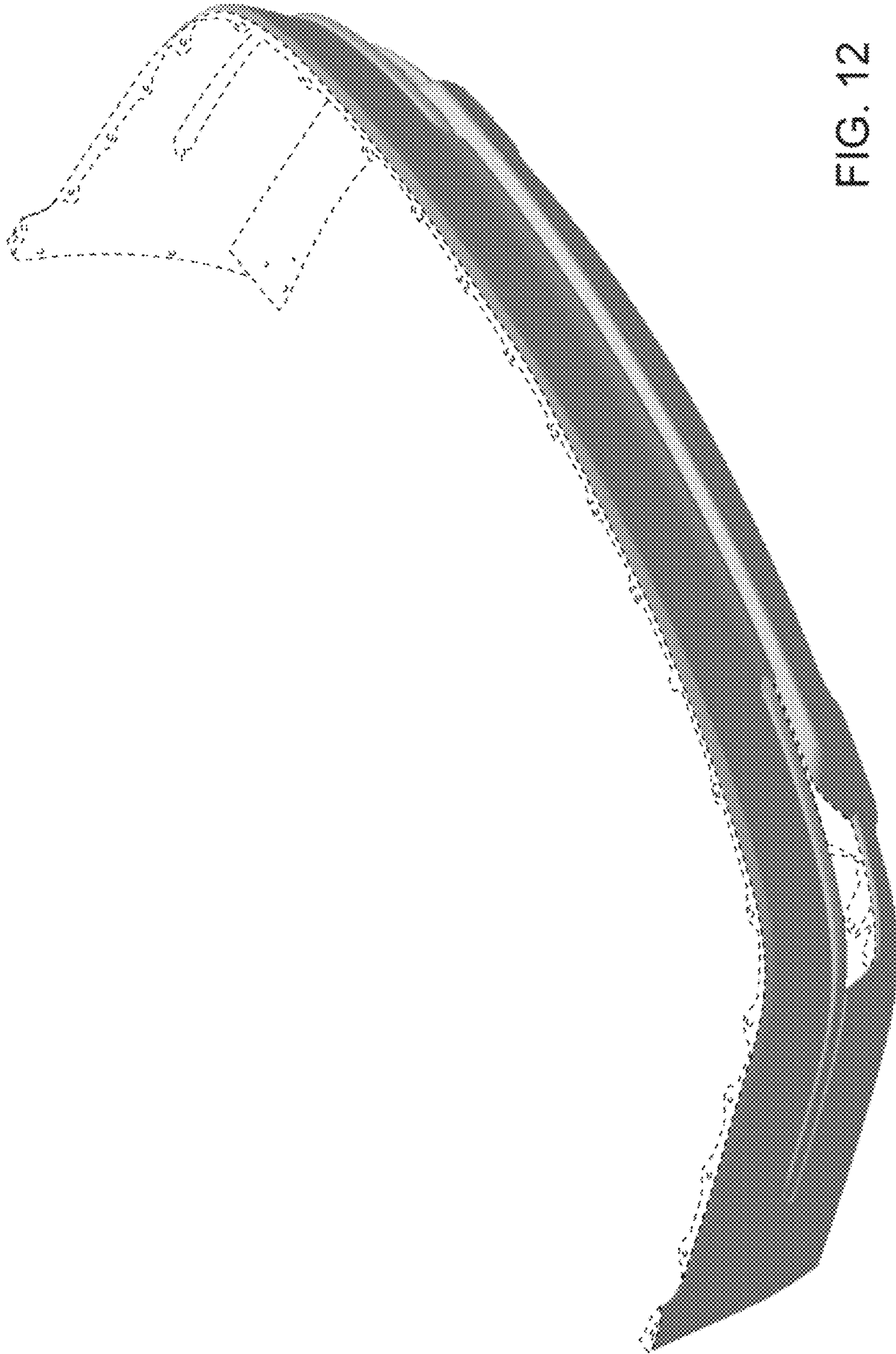

FIG. 12

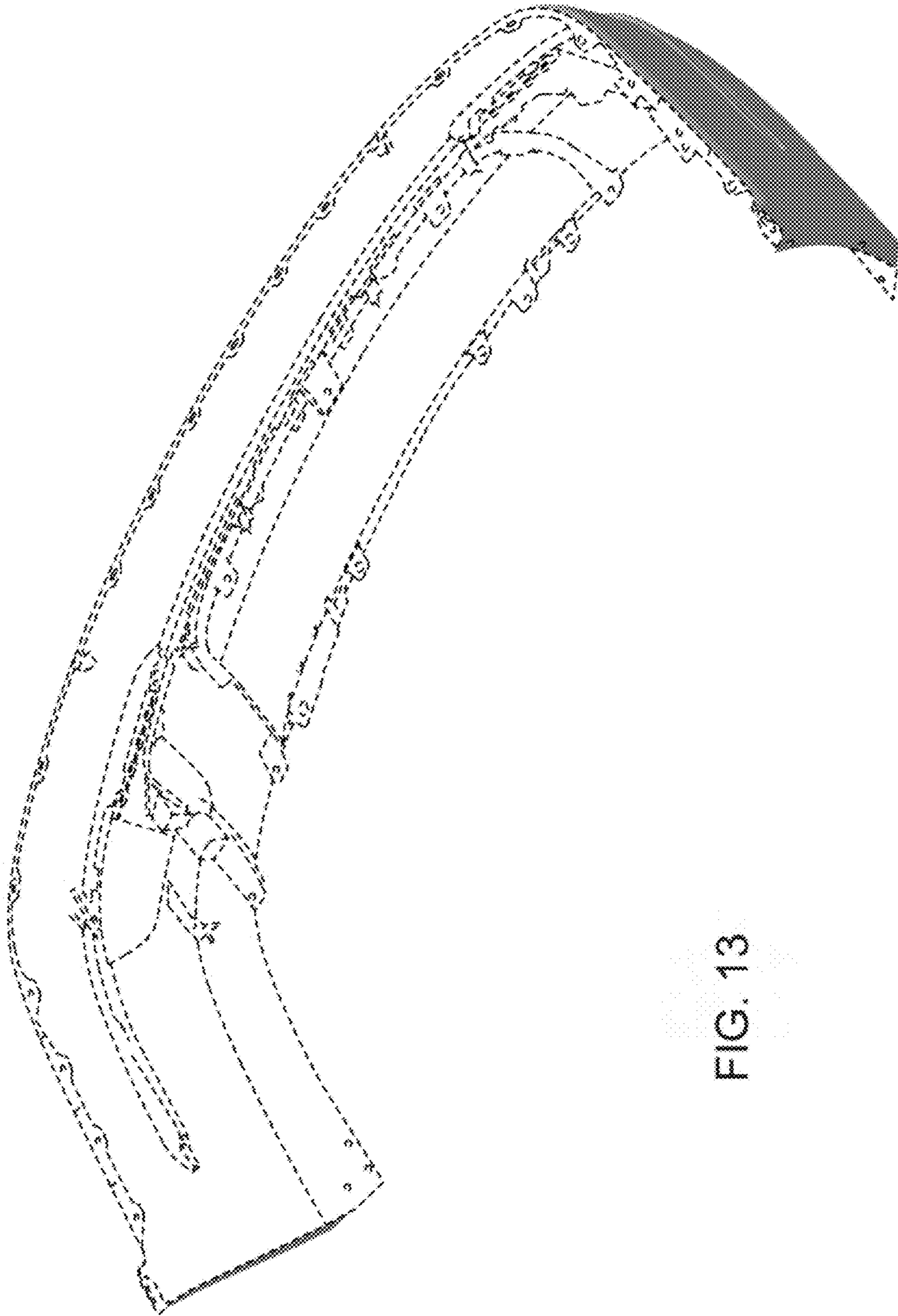

FIG. 13



FIG. 14

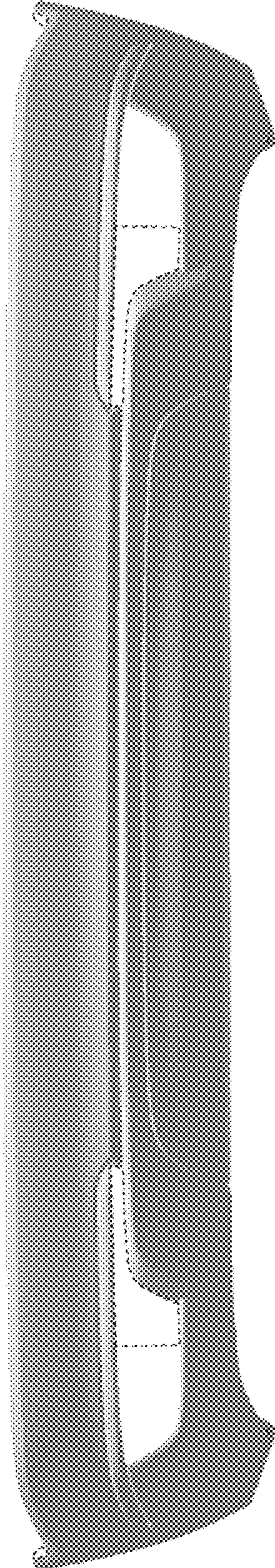

FIG. 15

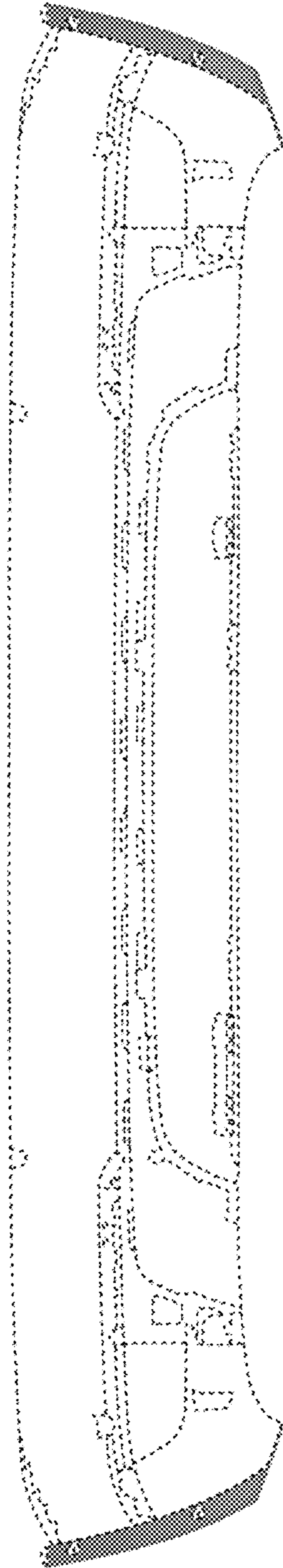

FIG. 16

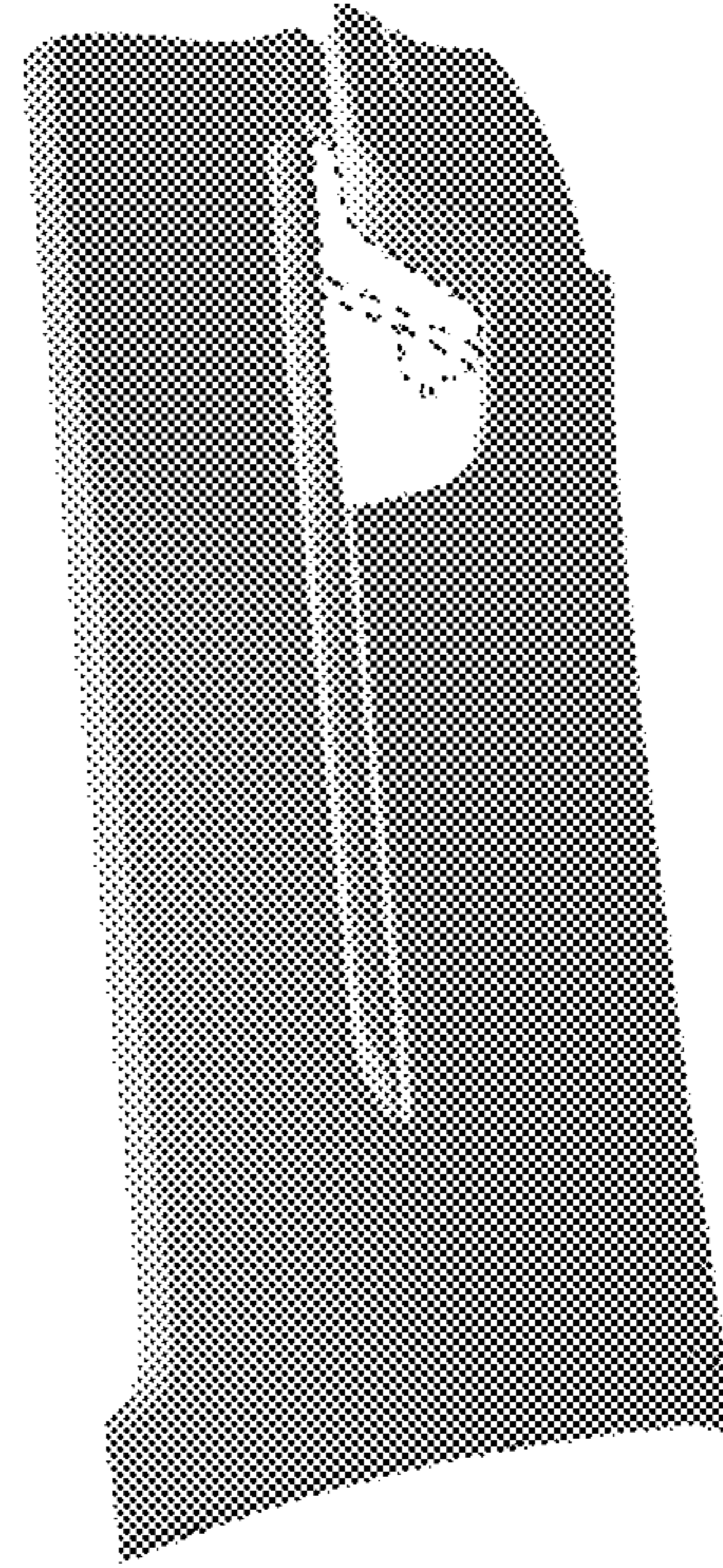

FIG. 17

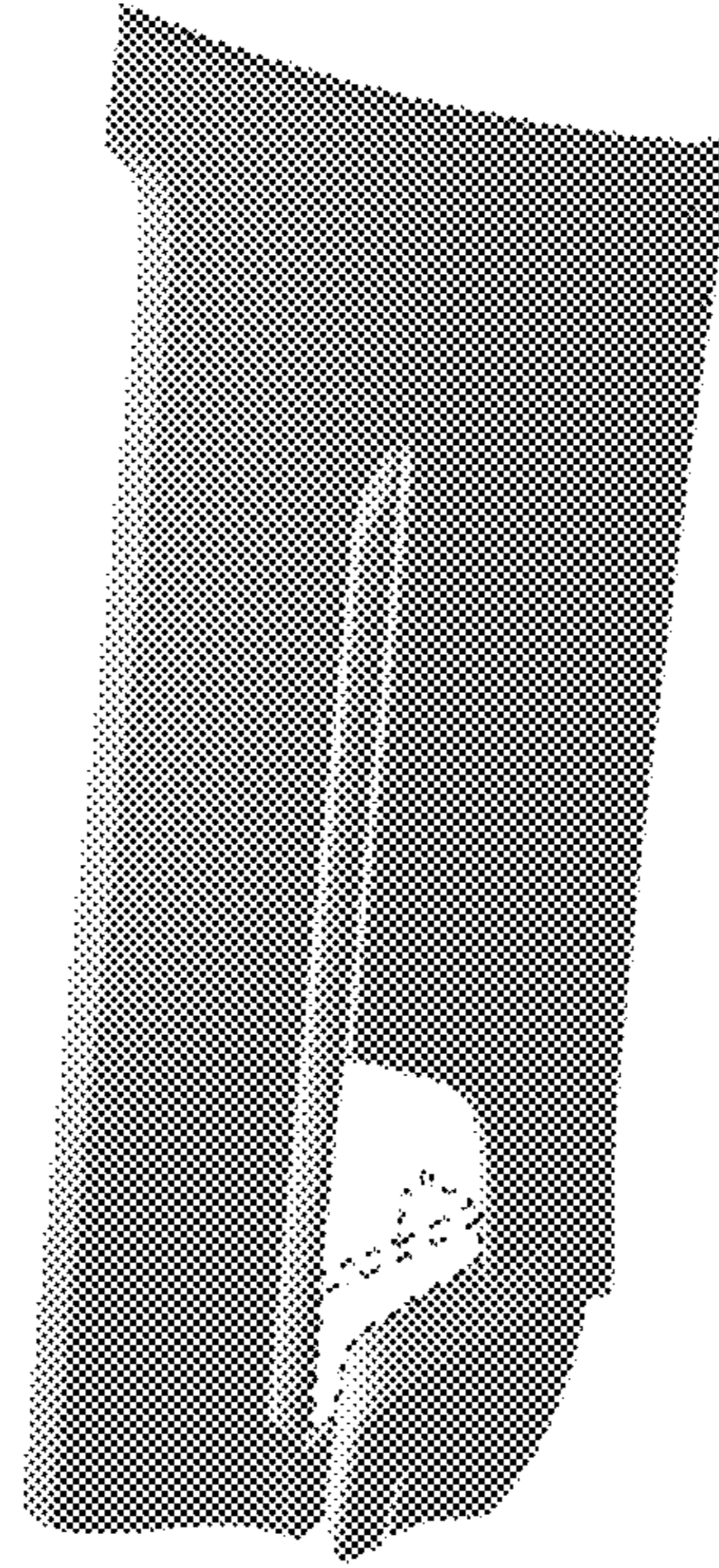

FIG. 18

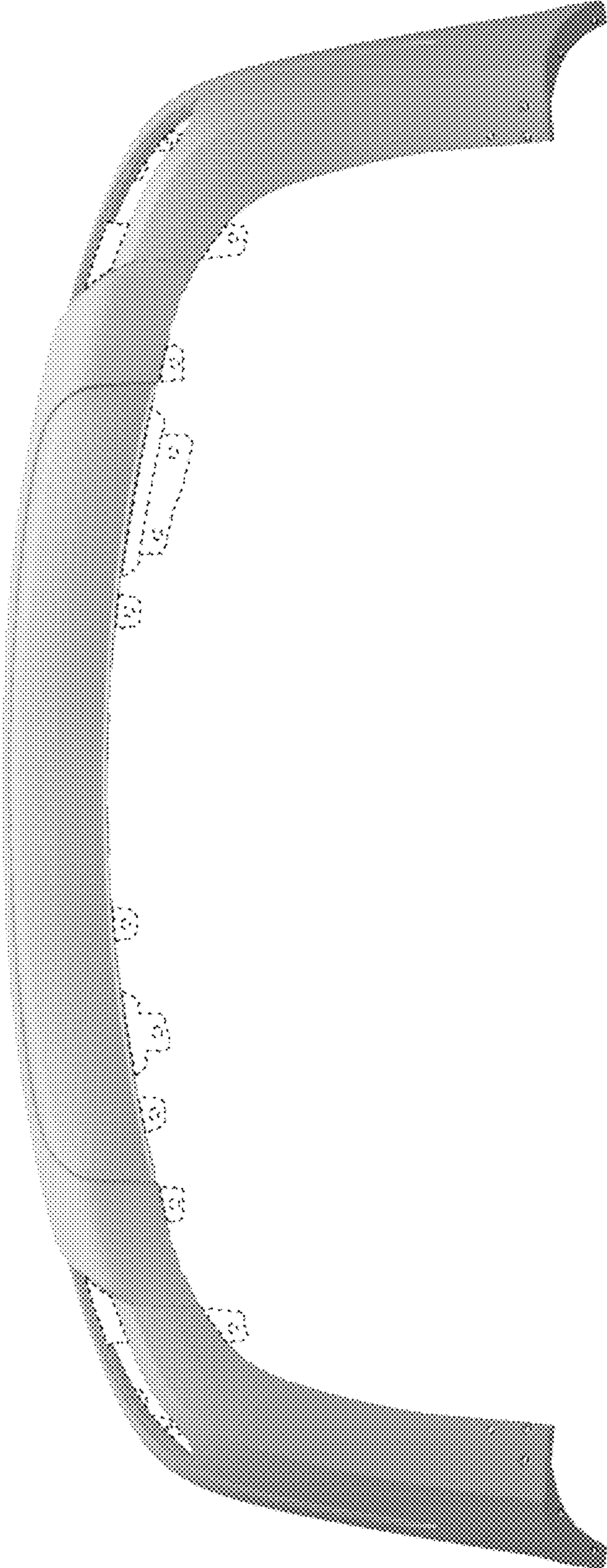

FIG. 19

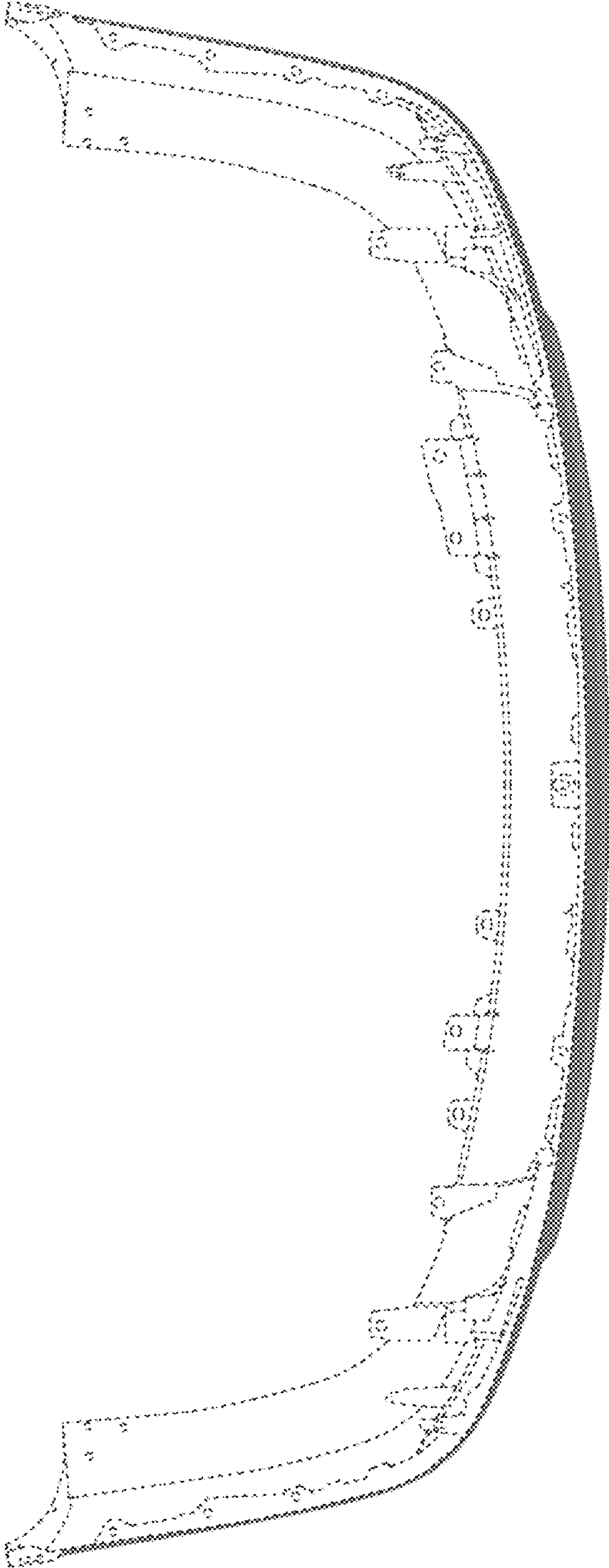

FIG. 20