



US00D879559S

(12) **United States Design Patent**  
**Lowette**

(10) **Patent No.:** **US D879,559 S**  
(45) **Date of Patent:** **\*\* Mar. 31, 2020**

(54) **BOTTLE**

(71) Applicant: **BIBO BRANDS BVBA**, Hasselt (BE)

(72) Inventor: **Stijn Lowette**, Hasselt (BE)

(73) Assignee: **Bibo Brands BVBA**, Hasselt (BE)

(\*\*) Term: **15 Years**

(21) Appl. No.: **29/655,235**

(22) Filed: **Jul. 2, 2018**

(30) **Foreign Application Priority Data**

Mar. 26, 2018 (EM) ..... 005120003-0002

(51) **LOC (12) Cl.** ..... **07-01**

(52) **U.S. Cl.**

USPC ..... **D7/531**; D7/532; D9/550; D9/553

(58) **Field of Classification Search**

USPC ..... D7/507, 509, 510, 511, 529, 530, 531,  
D7/532, 523, 534, 536, 608, 392.1, 396.2,  
D7/514, 515, 516, 519; D9/500, 501,  
D9/502, 503, 504, 612, 605, 301, 600,  
D9/685, 442, 529, 530, 537, 550, 553,  
D9/566, 563, 549

CPC ..... A47G 19/22; A47G 19/2288; A47G  
19/2205; A47G 19/2222; A47G 19/2233;  
A47G 19/2266; B65D 47/066

See application file for complete search history.

(56) **References Cited**

**U.S. PATENT DOCUMENTS**

D282,050 S \* 1/1986 Beaver ..... D9/547  
D689,331 S \* 9/2013 Staton ..... D7/510

D698,657 S \* 2/2014 Bernstein ..... D7/510  
D724,896 S \* 3/2015 Williams ..... D7/511  
D745,408 S \* 12/2015 Koop ..... D9/550  
D762,418 S \* 8/2016 Sorensen ..... D7/511  
D766,090 S \* 9/2016 Boroski ..... D7/509  
D784,763 S \* 4/2017 Oshana ..... D7/509  
D793,165 S \* 8/2017 Rummel ..... D7/510  
D795,012 S \* 8/2017 Rummel ..... D7/510  
D800,501 S \* 10/2017 Rummel ..... D7/509  
D832,049 S \* 10/2018 Christener ..... D7/507  
D859,078 S \* 9/2019 Rummel ..... D7/510  
D859,080 S \* 9/2019 Rummel ..... D7/511  
D862,235 S \* 10/2019 Sanghavi ..... D9/529  
D863,888 S \* 10/2019 Meyers ..... D7/413

\* cited by examiner

*Primary Examiner* — Jae Liang

(74) *Attorney, Agent, or Firm* — Kirschstein, Israel,  
Schiffmiller & Pieroni, P.C.

(57) **CLAIM**

The ornamental design for a bottle, as shown and described.

**DESCRIPTION**

FIG. 1 is a top front perspective view of a bottle showing my new design.  
FIG. 2 is a top rear perspective view thereof.  
FIG. 3 is a front elevational view thereof.  
FIG. 4 is a rear elevational view thereof.  
FIG. 5 is a right side devotional view thereof, the left side being a mirror image.  
FIG. 6 is a top plan view thereof; and,  
FIG. 7 is a bottom plan view thereof.

**1 Claim, 6 Drawing Sheets**

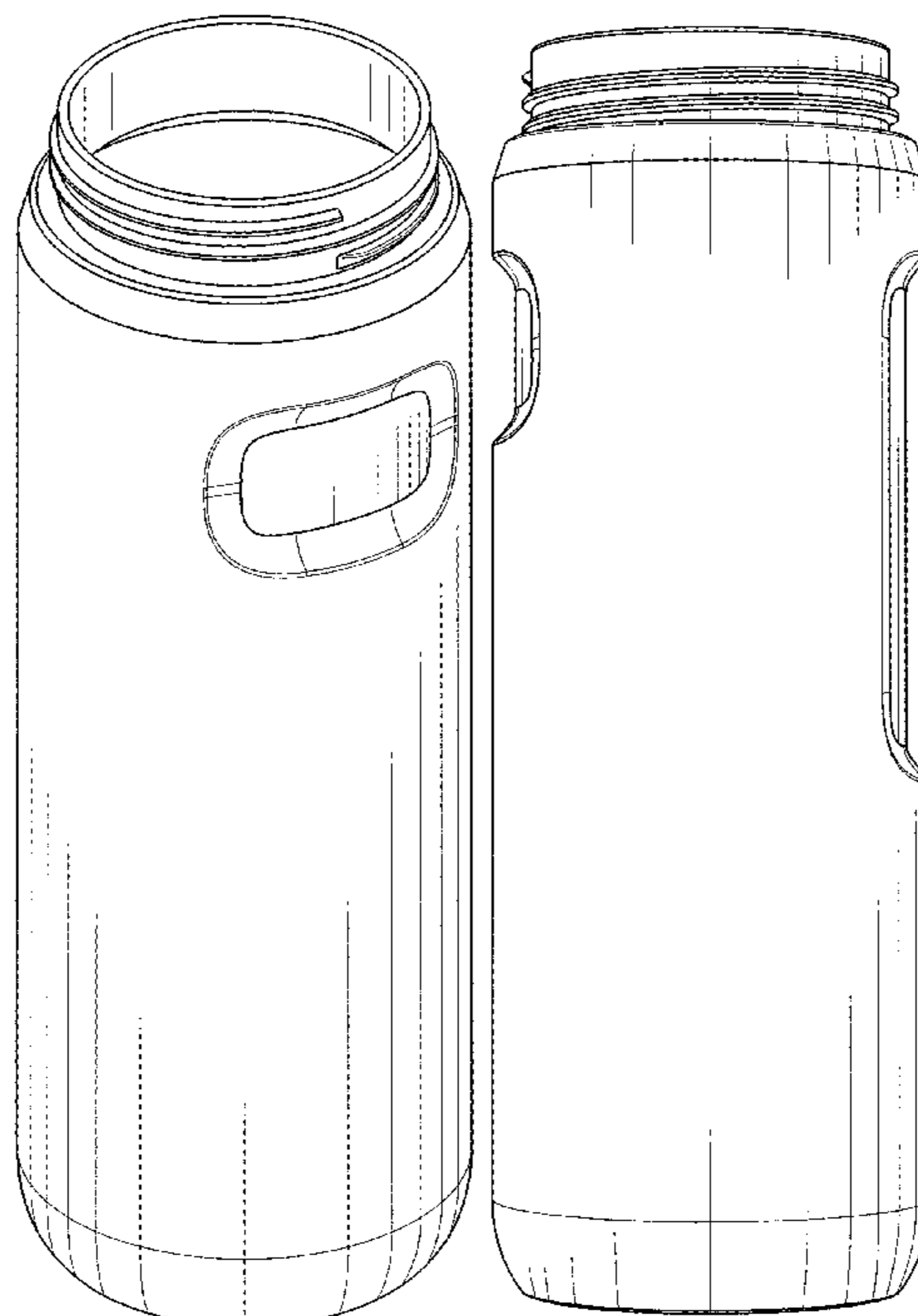

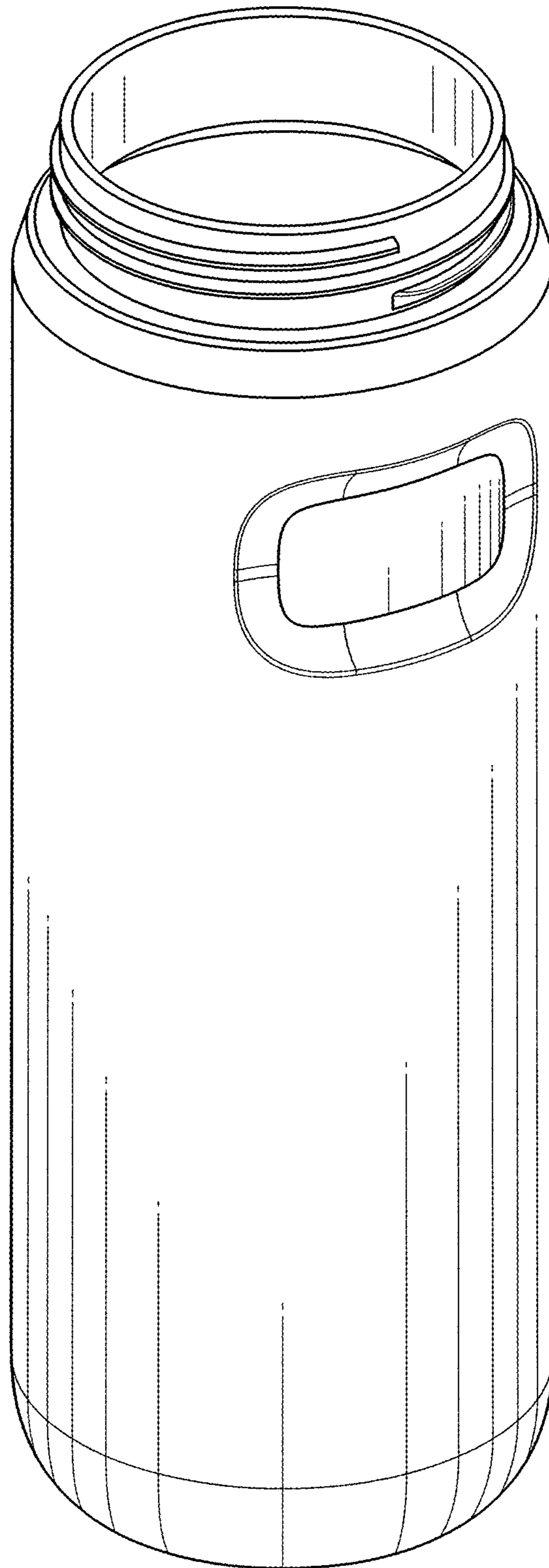

FIG. 1

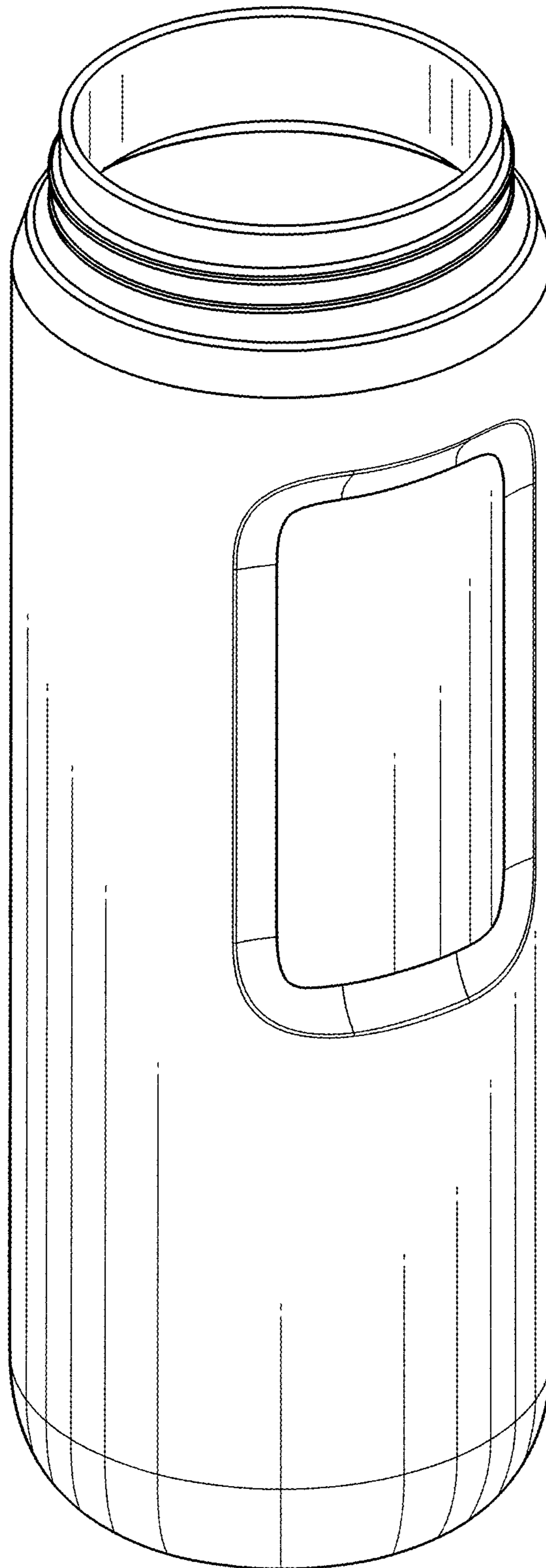

FIG. 2

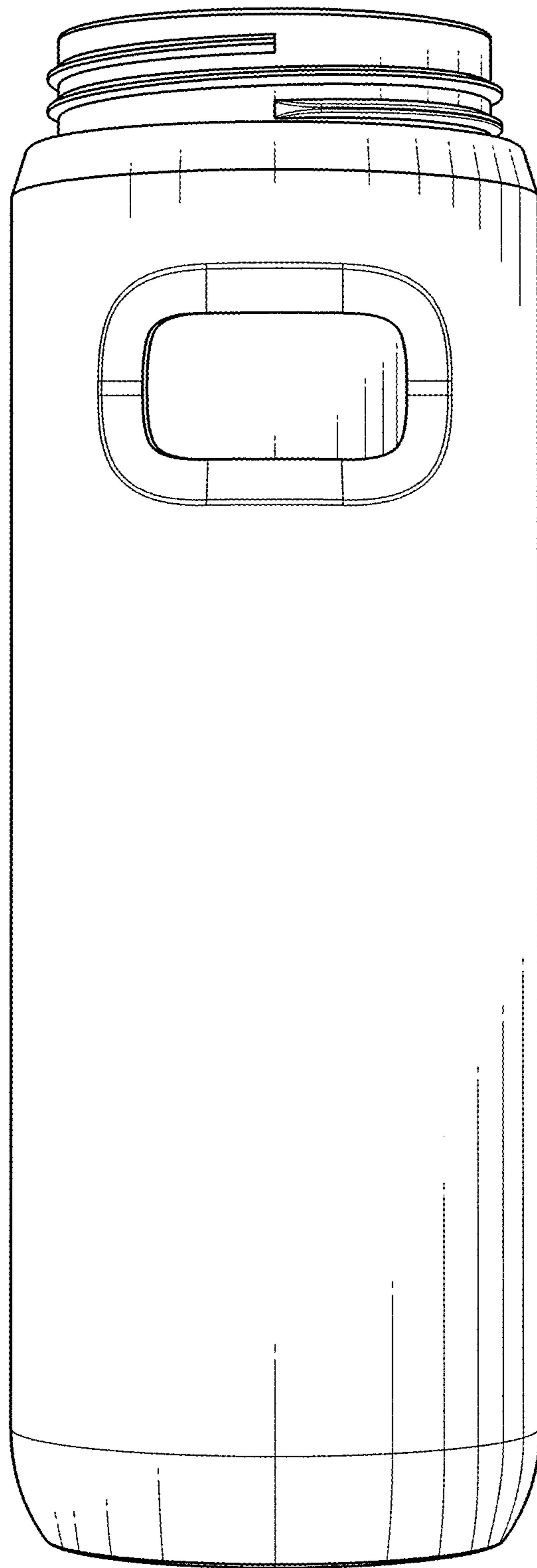

FIG. 3

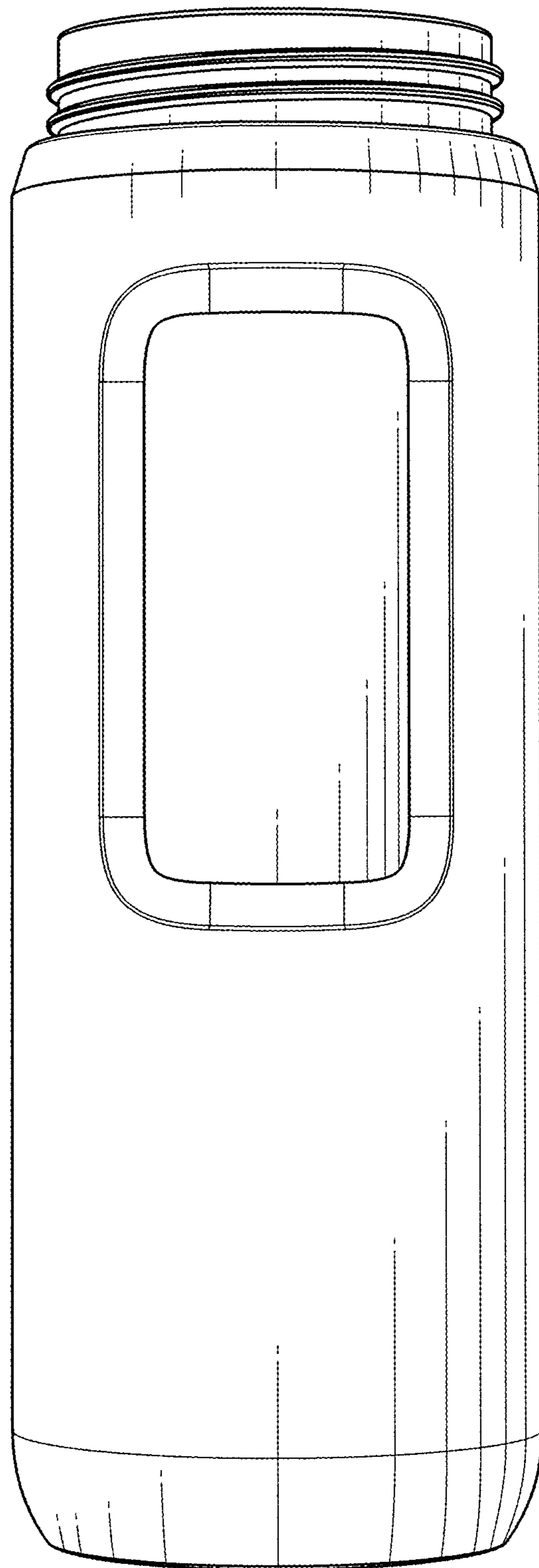

FIG. 4

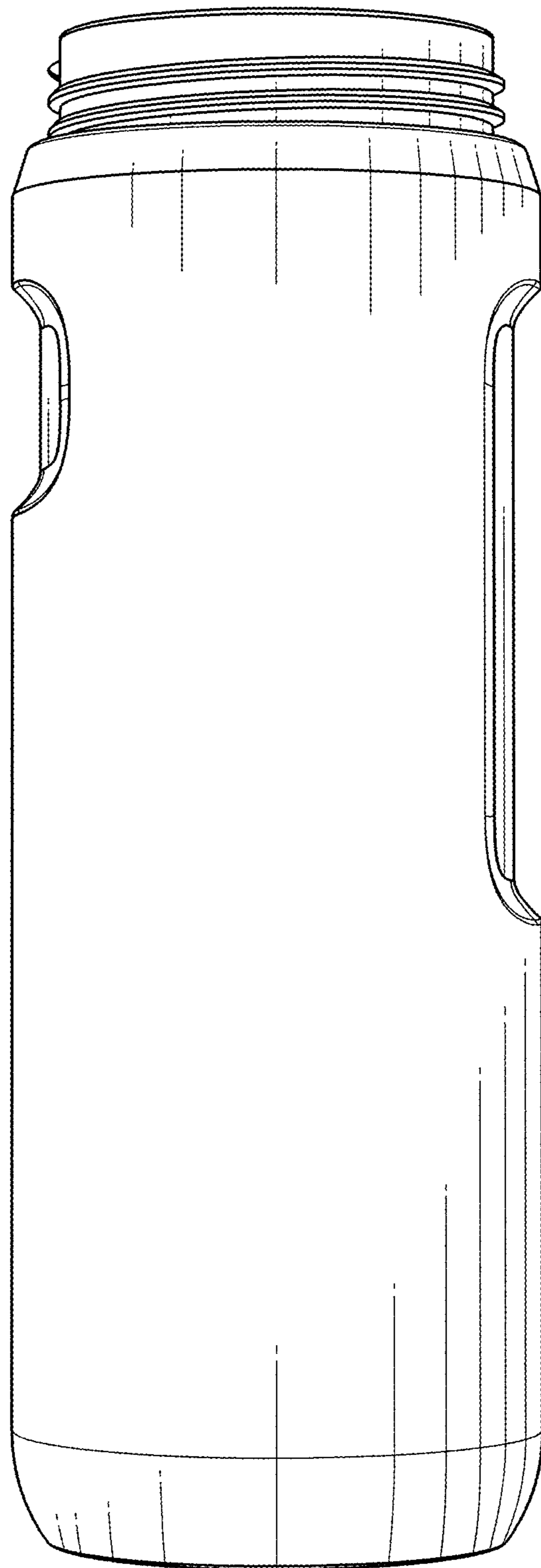

FIG. 5

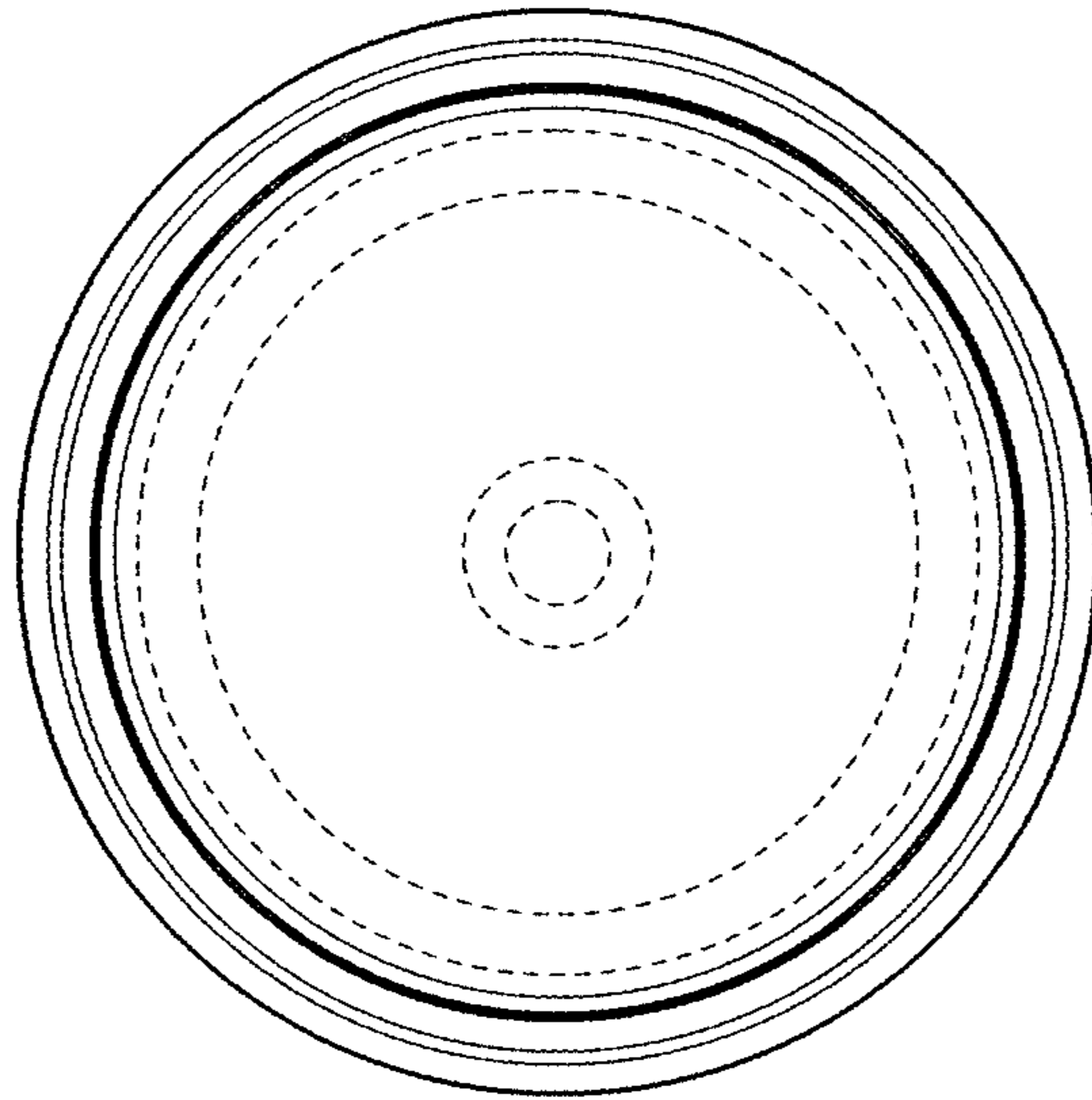

FIG. 6

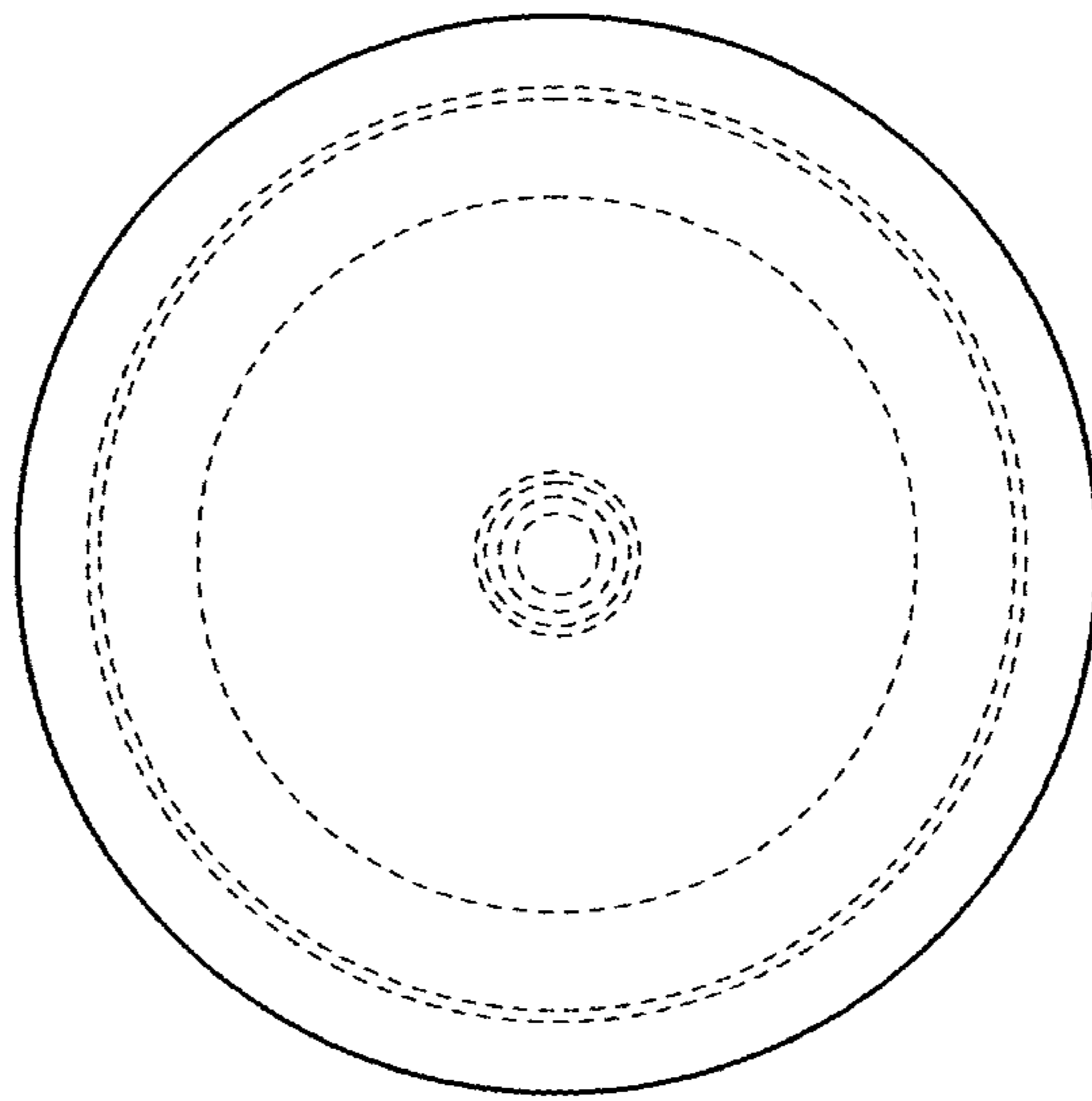

FIG. 7