



US00D879498S

(12) **United States Design Patent**  
**Yeo**

(10) **Patent No.:** **US D879,498 S**  
(45) **Date of Patent:** **\*\* Mar. 31, 2020**

(54) **DISPENSER FOR HYGIENE PAPER ROLLS**

(71) Applicant: **Oliver Yeo**, Devon (GB)

(72) Inventor: **Oliver Yeo**, Devon (GB)

(\*\*) Term: **15 Years**

(21) Appl. No.: **29/643,212**

(22) Filed: **Apr. 5, 2018**

(51) **LOC (12) Cl.** ..... **23-02**

(52) **U.S. Cl.**  
USPC ..... **D6/523**

(58) **Field of Classification Search**  
USPC ..... D6/515, 516, 517, 518, 519–523;  
D7/550.1, 609, 610, 611, 612, 325, 348,  
D7/350.1, 350.2, 367; 206/389;  
242/570, 590, 595, 596, 598, 598.5,  
242/598.6, 560; 312/34.1, 34.8; 221/1,  
221/26, 45, 212, 277  
CPC .... A47K 17/00; A47K 10/3836; A47K 10/38;  
A47K 2010/3863; A47K 2010/3253;  
A47K 10/36; A47K 10/40; A47K 10/22;  
A47K 10/32; A47K 10/34; A47K  
10/3687; A47K 10/3827; A47K 10/3818;  
A47K 10/405; A47K 2010/3246; A47K  
2010/326

See application file for complete search history.

(56) **References Cited**

**U.S. PATENT DOCUMENTS**

5,449,127 A \* 9/1995 Davis ..... A47K 10/38  
242/560  
D667,661 S \* 9/2012 Norton ..... D6/520

D726,440 S \* 4/2015 Giovannoni ..... D6/518  
D829,018 S \* 9/2018 Meyerhoffer ..... D6/523  
2009/0200329 A1\* 8/2009 Balkin ..... A47K 10/32  
221/45

\* cited by examiner

*Primary Examiner* — Wan Laymon

*Assistant Examiner* — Mark Booker

(74) *Attorney, Agent, or Firm* — Reichel Stohry Dean  
LLP; Mark C. Reichel; Natalie J. Dean

(57) **CLAIM**

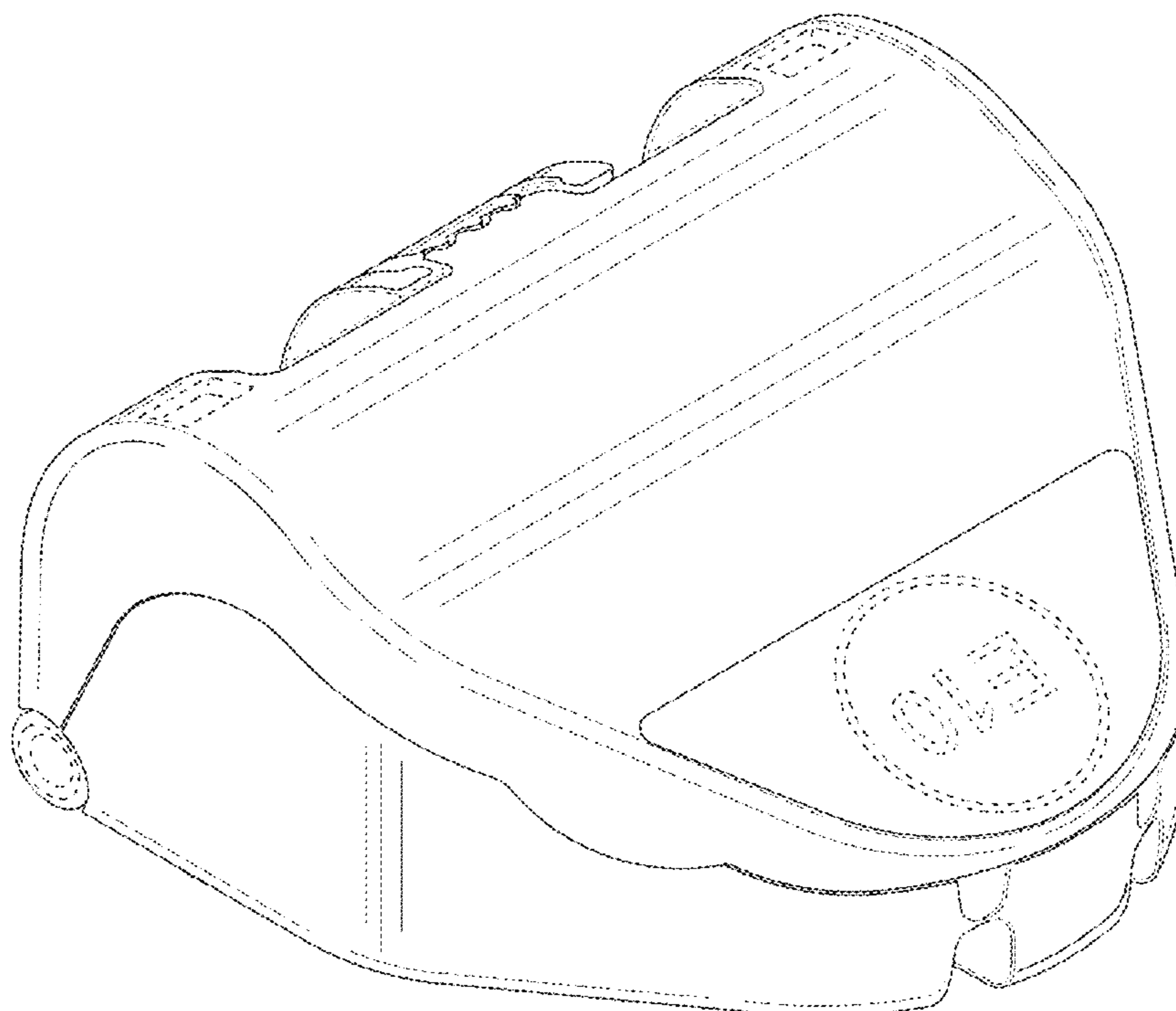
The ornamental design for a dispenser for hygiene paper rolls, as shown and described.

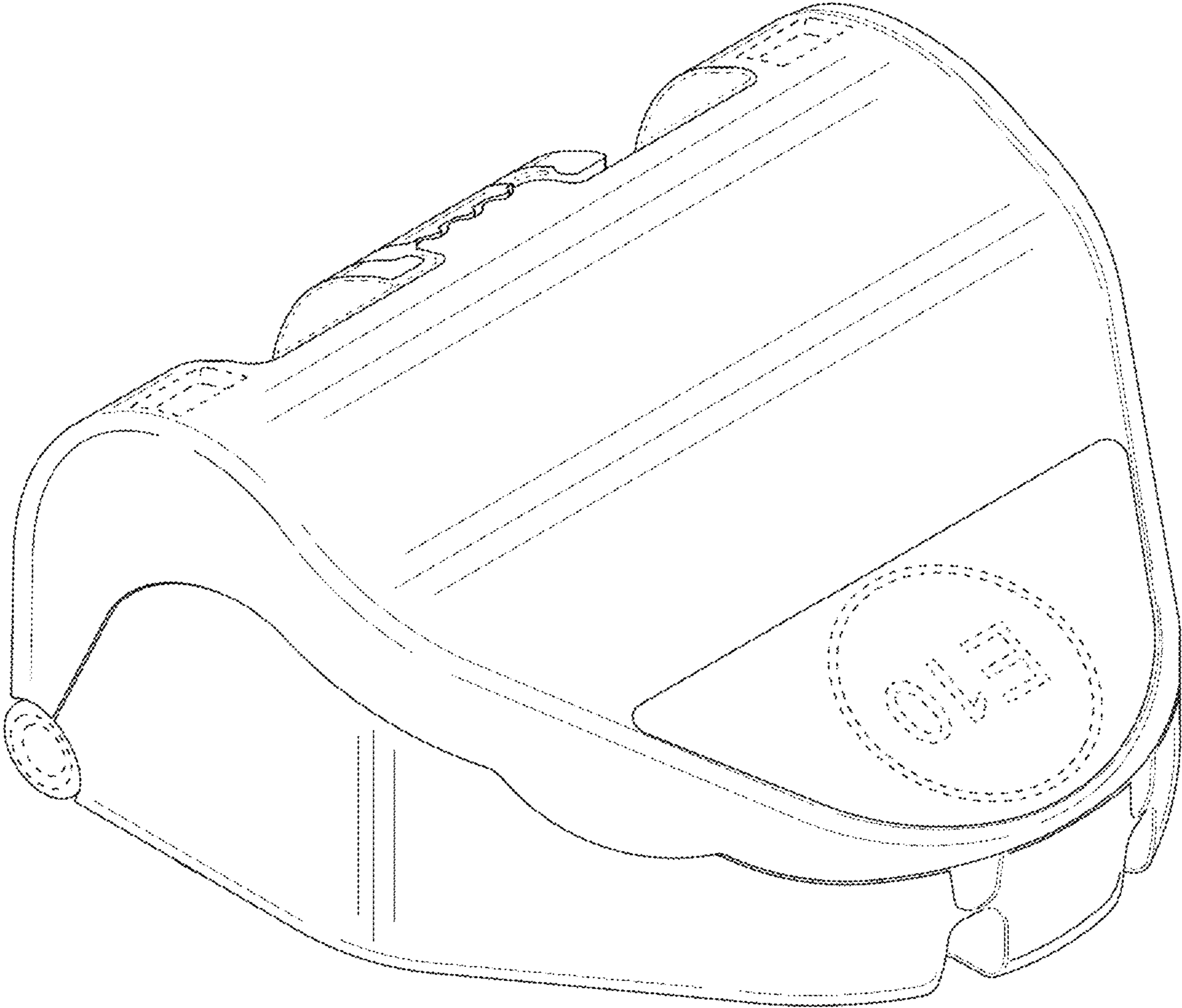
**DESCRIPTION**

FIG. 1 is a top perspective view of a dispenser for hygiene paper rolls showing my new design;  
FIG. 2 is a bottom perspective view thereof;  
FIG. 3 is a front view thereof;  
FIG. 4 is a top view thereof;  
FIG. 5 is a left side view thereof;  
FIG. 6 is a bottom view thereof;  
FIG. 7 is a right side view thereof; and,  
FIG. 8 is a back view thereof.

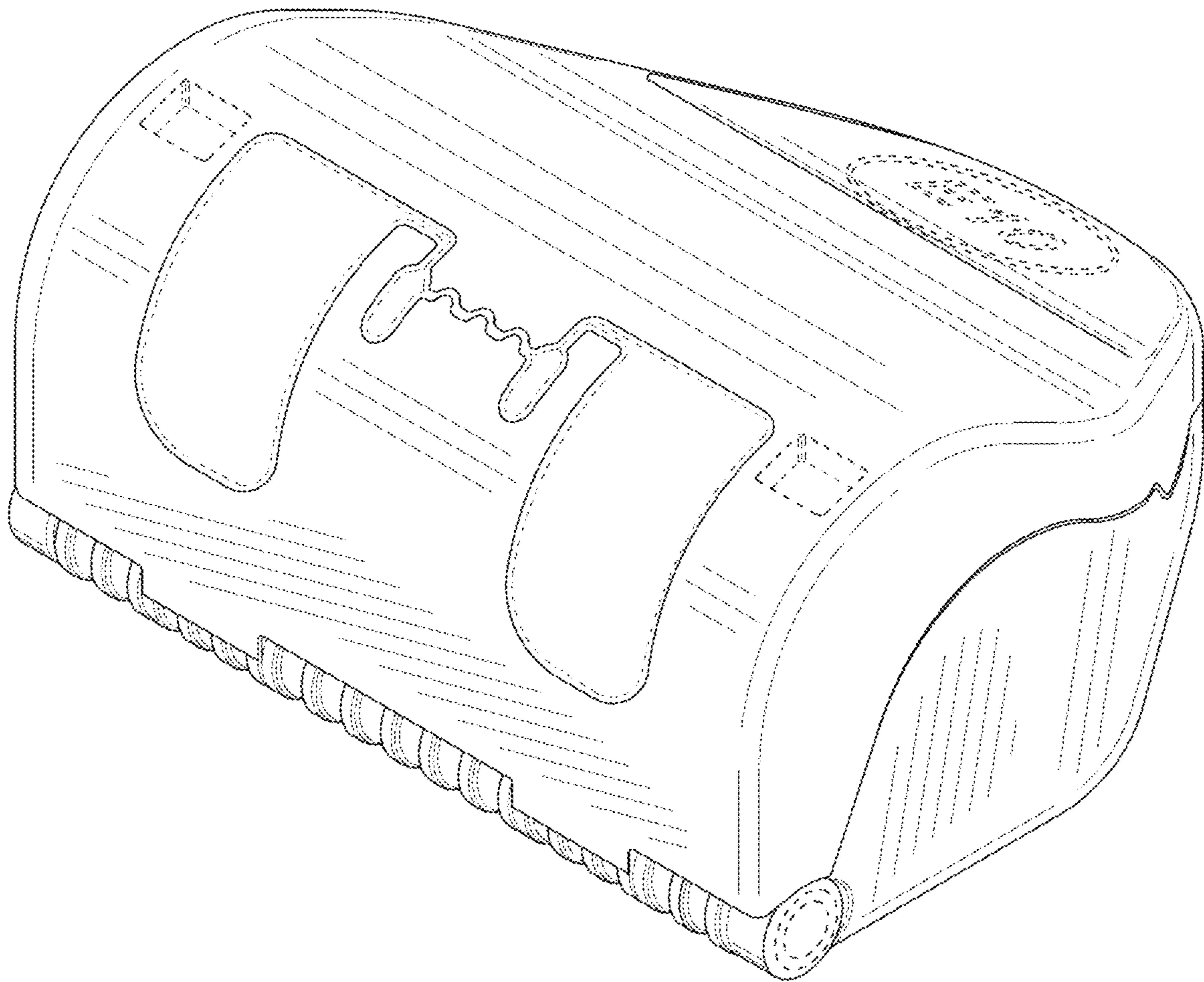
The broken lines in the drawing depict portions of the dispenser for hygiene paper rolls that form no part of the claimed design.

**1 Claim, 8 Drawing Sheets**

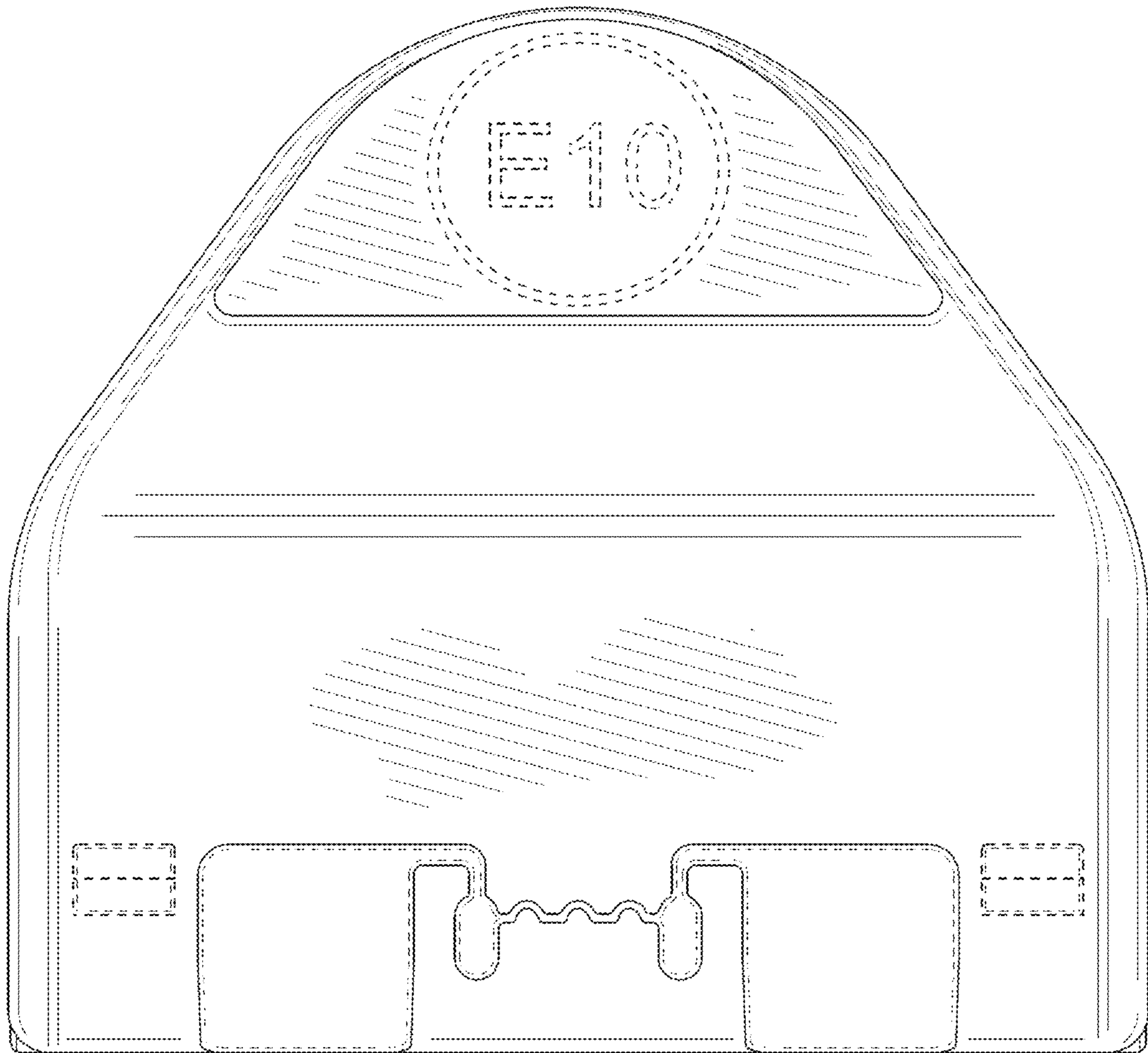




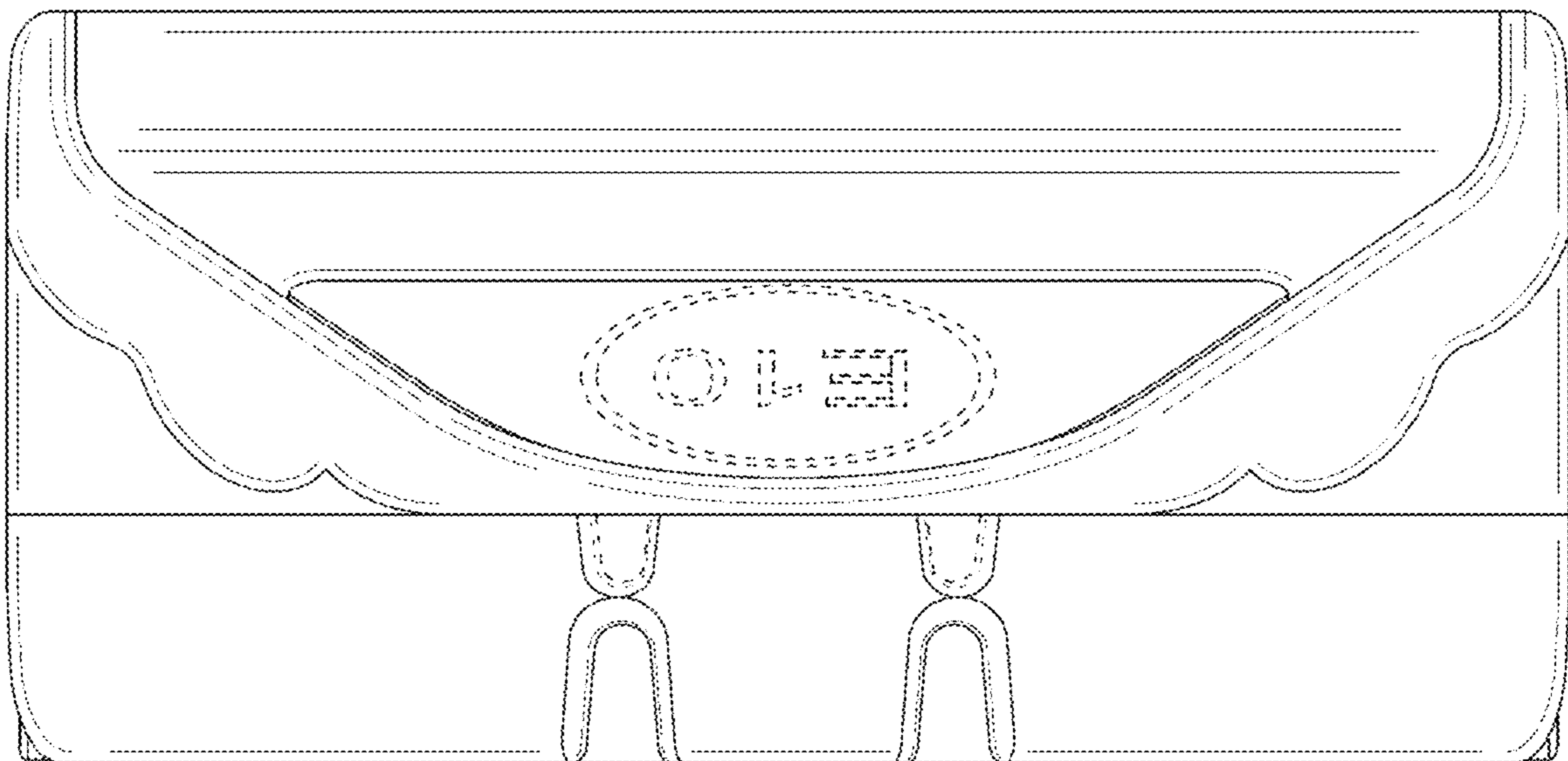
**FIG. 1**



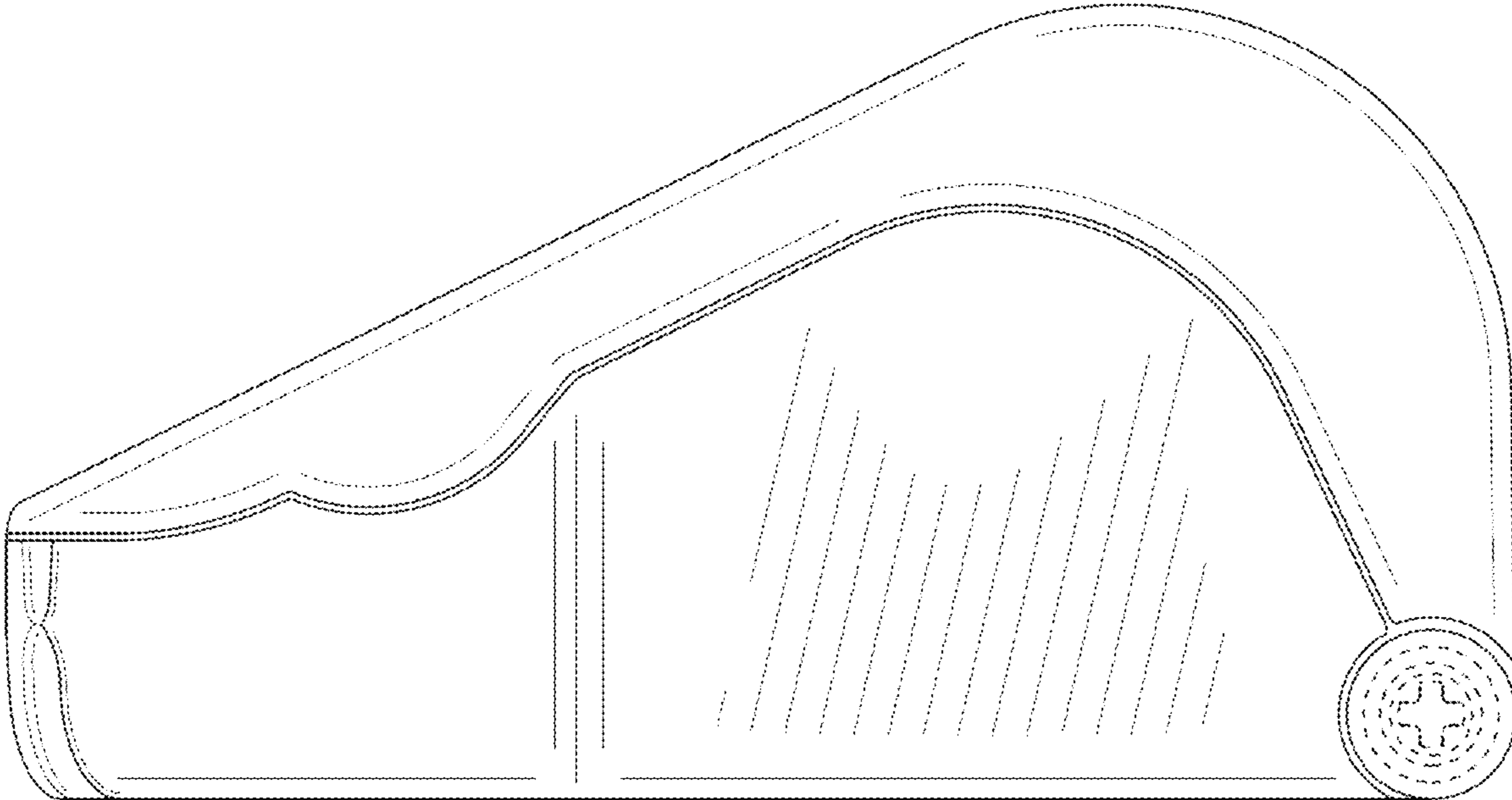
**FIG. 2**



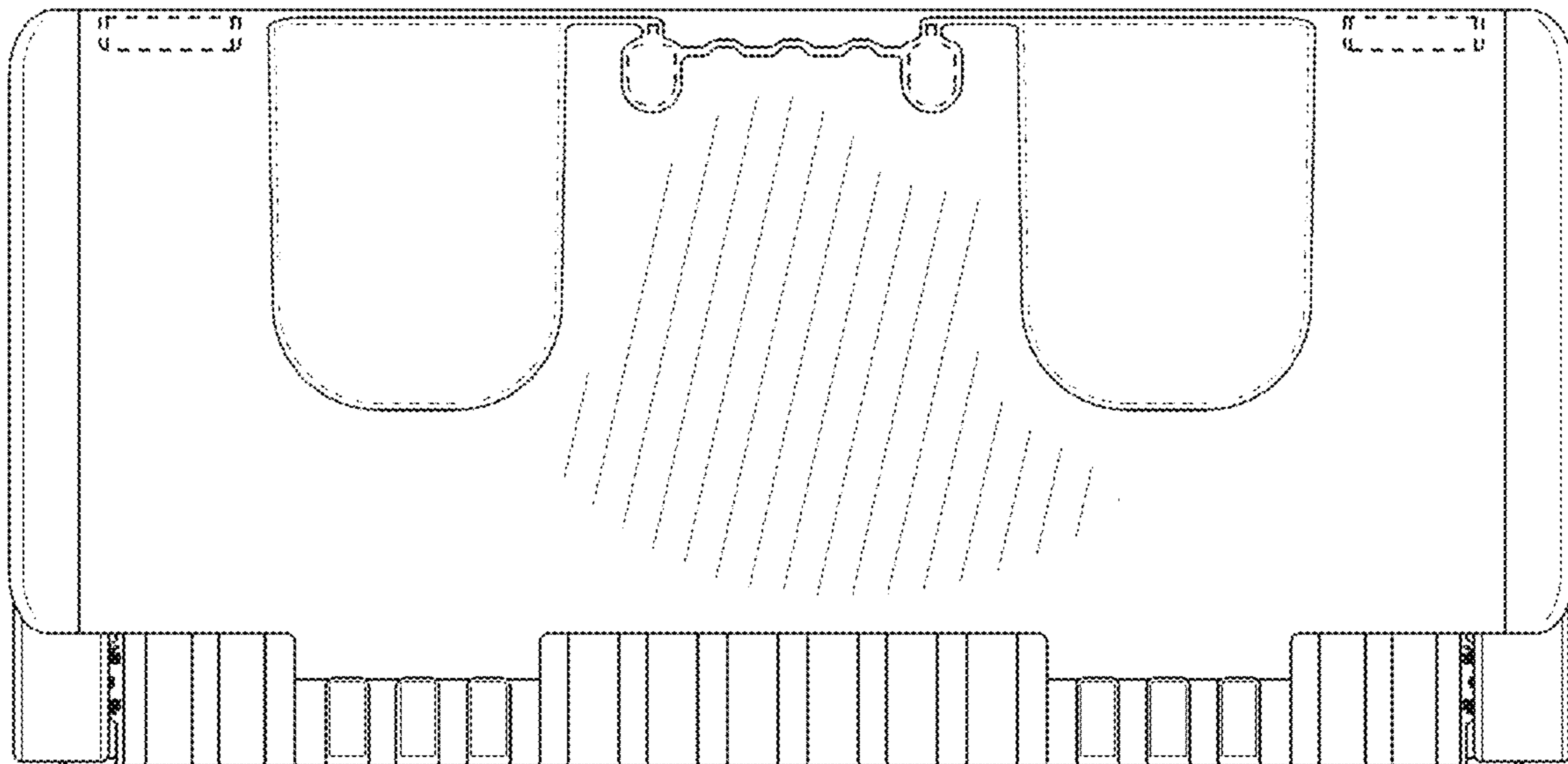
**FIG. 3**



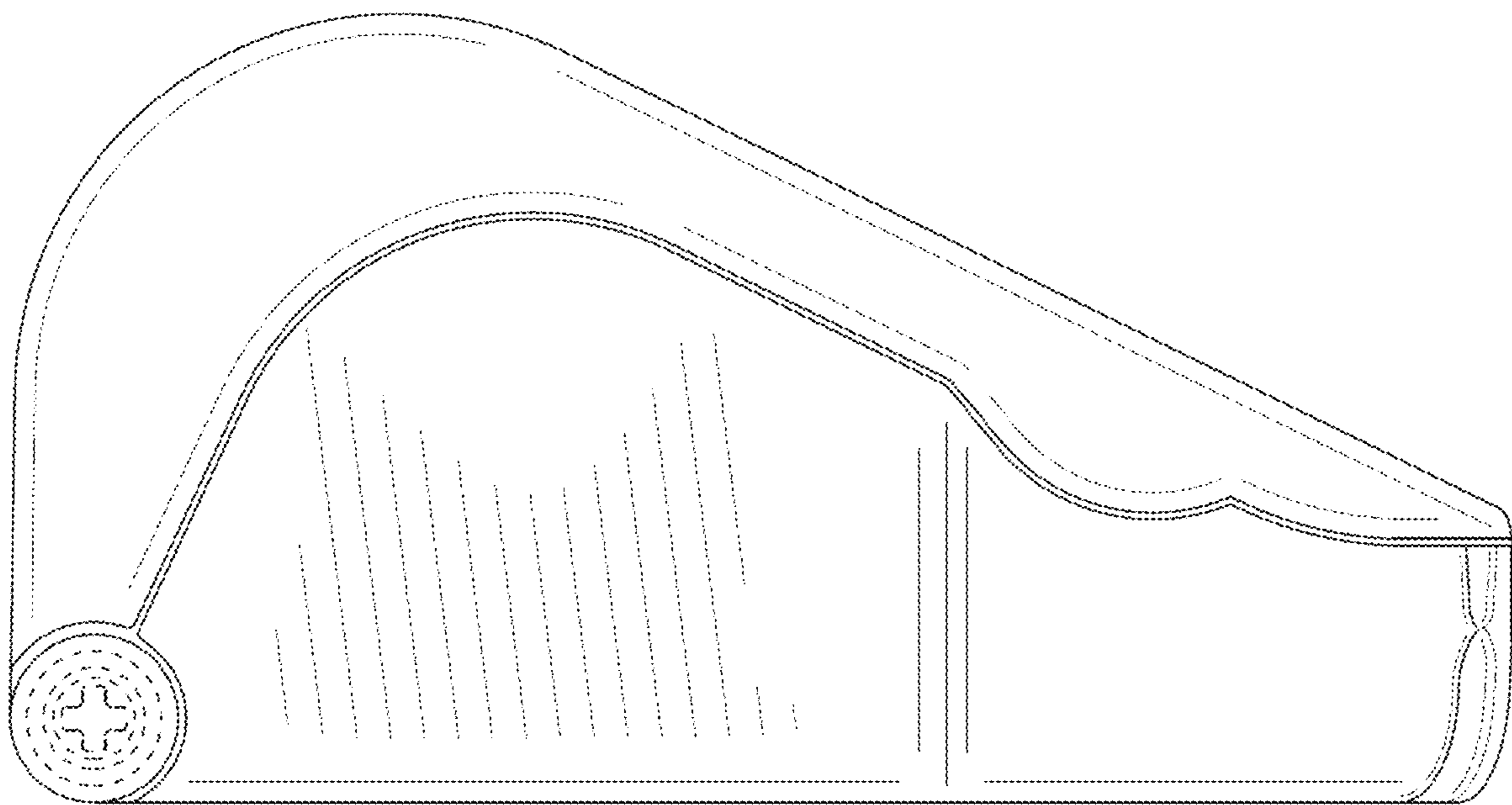
**FIG. 4**



**FIG. 5**

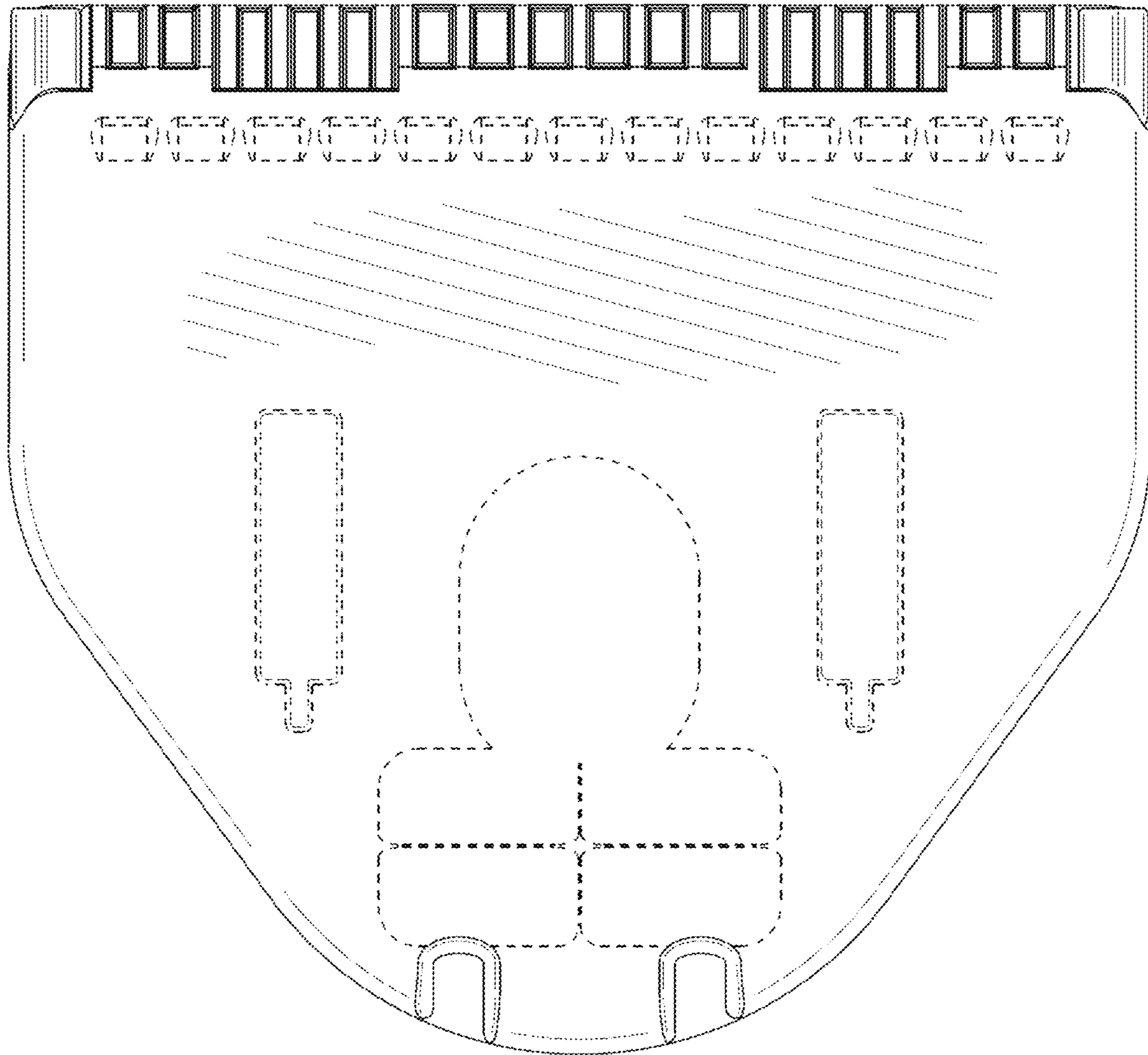


**FIG. 6**



**FIG. 7**





**FIG. 8**