



US00D879451S

(12) **United States Design Patent**  
**Ikeda et al.**

(10) **Patent No.:** **US D879,451 S**  
(45) **Date of Patent:** **\*\* Mar. 31, 2020**

- (54) **SHOE**
- (71) Applicant: **NIKE, Inc.**, Beaverton, OR (US)
- (72) Inventors: **Erick Ikeda**, Beaverton, OR (US);  
**Kreig Hozalski**, Beaverton, OR (US)
- (73) Assignee: **NIKE, Inc.**, Beaverton, OR (US)
- (\*\*) Term: **15 Years**
- (21) Appl. No.: **29/676,565**
- (22) Filed: **Jan. 11, 2019**
- (51) **LOC (12) Cl.** ..... **02-04**
- (52) **U.S. Cl.**  
USPC ..... **D2/972**
- (58) **Field of Classification Search**  
USPC ..... D2/896-900, 902-907, 909-912, 923,  
D2/946, 969, 972-974  
CPC ..... A43C 5/00-02; A43B 23/00; A43B 21/00;  
A43B 3/16; A43B 3/136  
See application file for complete search history.

- D628,781 S \* 12/2010 Butler ..... D2/946
- D776,908 S \* 1/2017 Arnold ..... D2/970
- D796,176 S \* 9/2017 Raysse ..... D2/969
- D827,259 S \* 9/2018 Amzallag ..... D2/923

\* cited by examiner

*Primary Examiner* — Rashida C. Walshon  
(74) *Attorney, Agent, or Firm* — Banner & Witcoff, Ltd.

(57) **CLAIM**  
The ornamental design for a shoe, as shown and described.

**DESCRIPTION**

FIG. 1 is a front perspective view of a shoe showing our new design;  
 FIG. 2 is a side view thereof;  
 FIG. 3 is a rear perspective view thereof;  
 FIG. 4 is a rear view thereof;  
 FIG. 5 is an opposite rear perspective view thereof;  
 FIG. 6 is an opposite side view thereof;  
 FIG. 7 is an opposite front perspective view thereof;  
 FIG. 8 is a front perspective view of the shoe of FIGS. 1-7 shown in an open configuration;  
 FIG. 9 is a side view thereof;  
 FIG. 10 is a rear perspective view thereof;  
 FIG. 11 is a rear view thereof;  
 FIG. 12 is an opposite rear perspective view thereof;  
 FIG. 13 is an opposite side view thereof; and,  
 FIG. 14 is an opposite front perspective view thereof.  
 The broken lines immediately adjacent to the shaded area define the bounds of the claimed design and form no part thereof. The broken lines depicting the remainder of the shoe show features that form no part of the claimed design.

**1 Claim, 14 Drawing Sheets**

- (56) **References Cited**  
U.S. PATENT DOCUMENTS
- 1,716,346 A \* 6/1929 Rice ..... A43B 3/16  
36/7.3
- D128,475 S \* 7/1941 Bergman ..... D2/943
- D319,917 S \* 9/1991 Mishima ..... D2/903
- D436,433 S \* 1/2001 Laberge ..... D2/972
- D449,433 S \* 10/2001 Matis ..... D2/902
- D537,240 S \* 2/2007 Aussems ..... D2/919
- D626,737 S \* 11/2010 Dean ..... D2/923

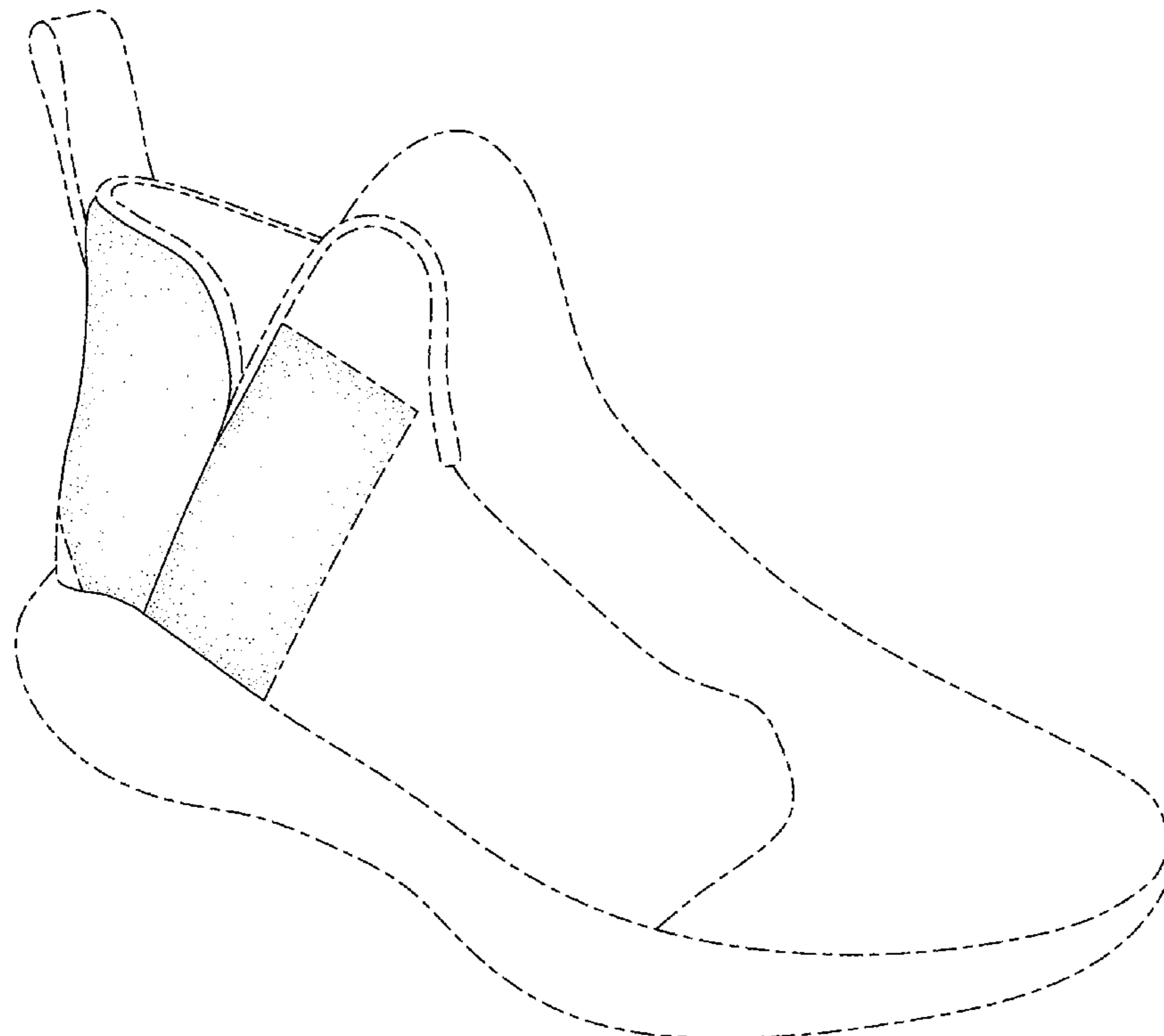

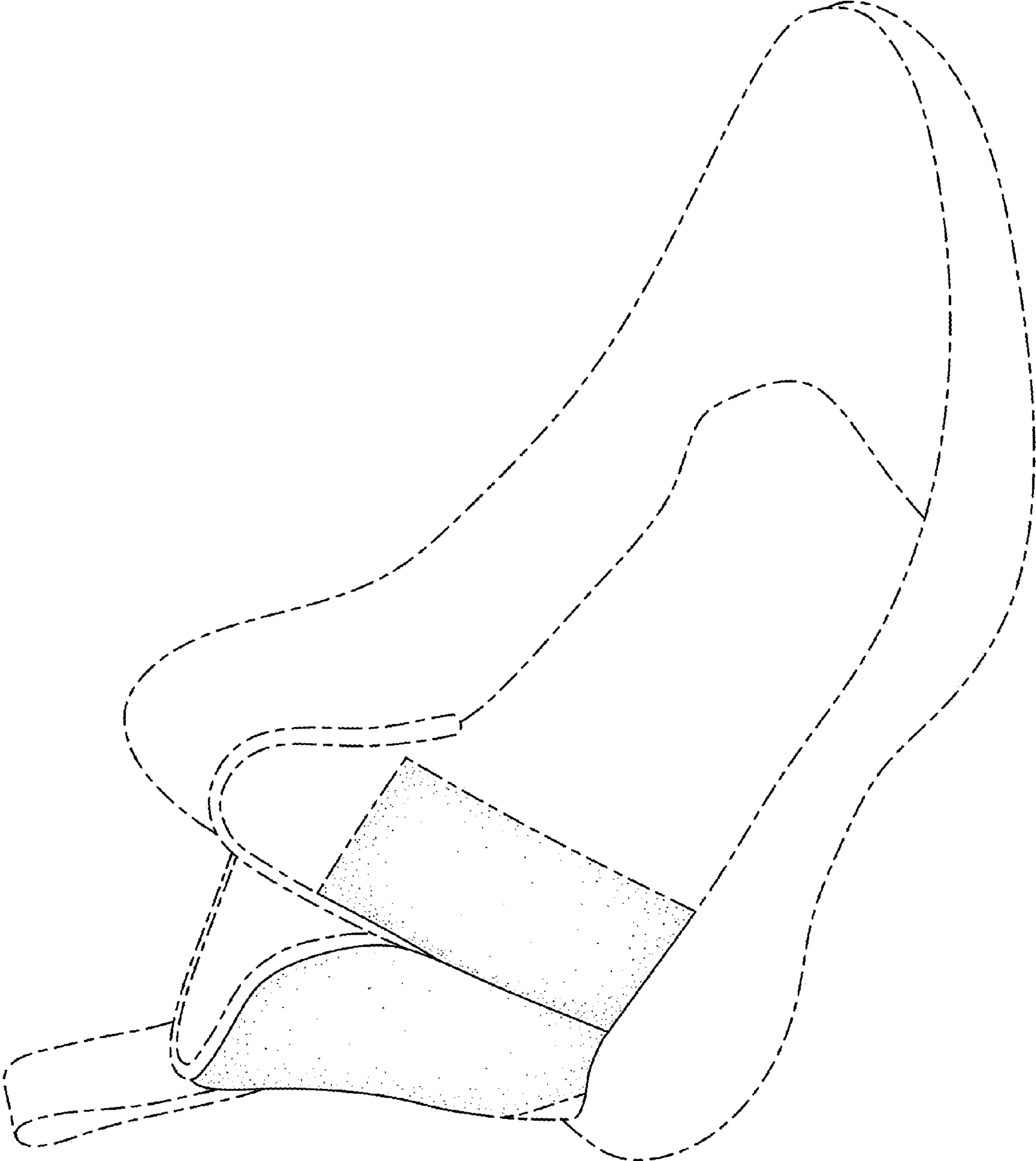

FIG. 1

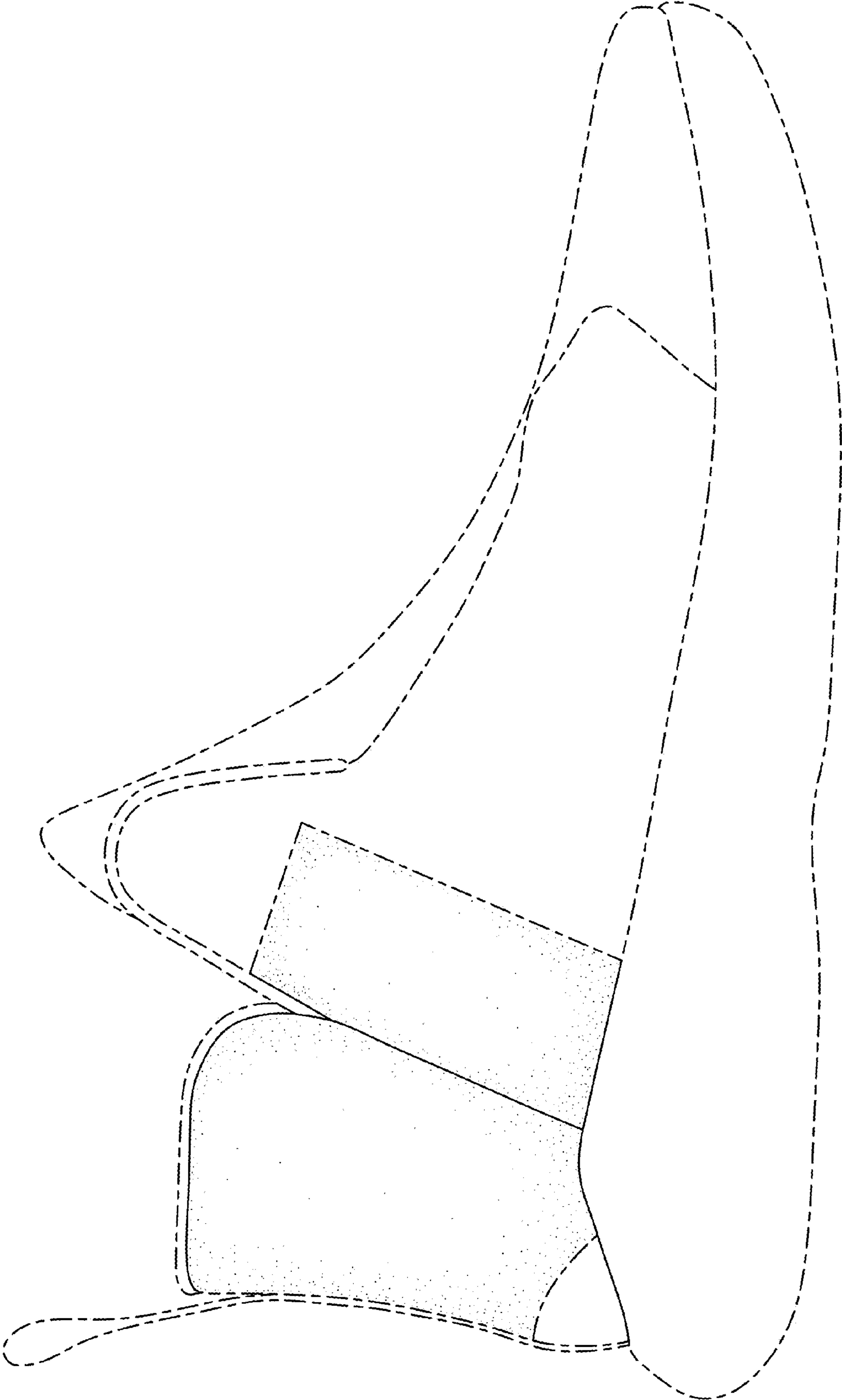

FIG. 2

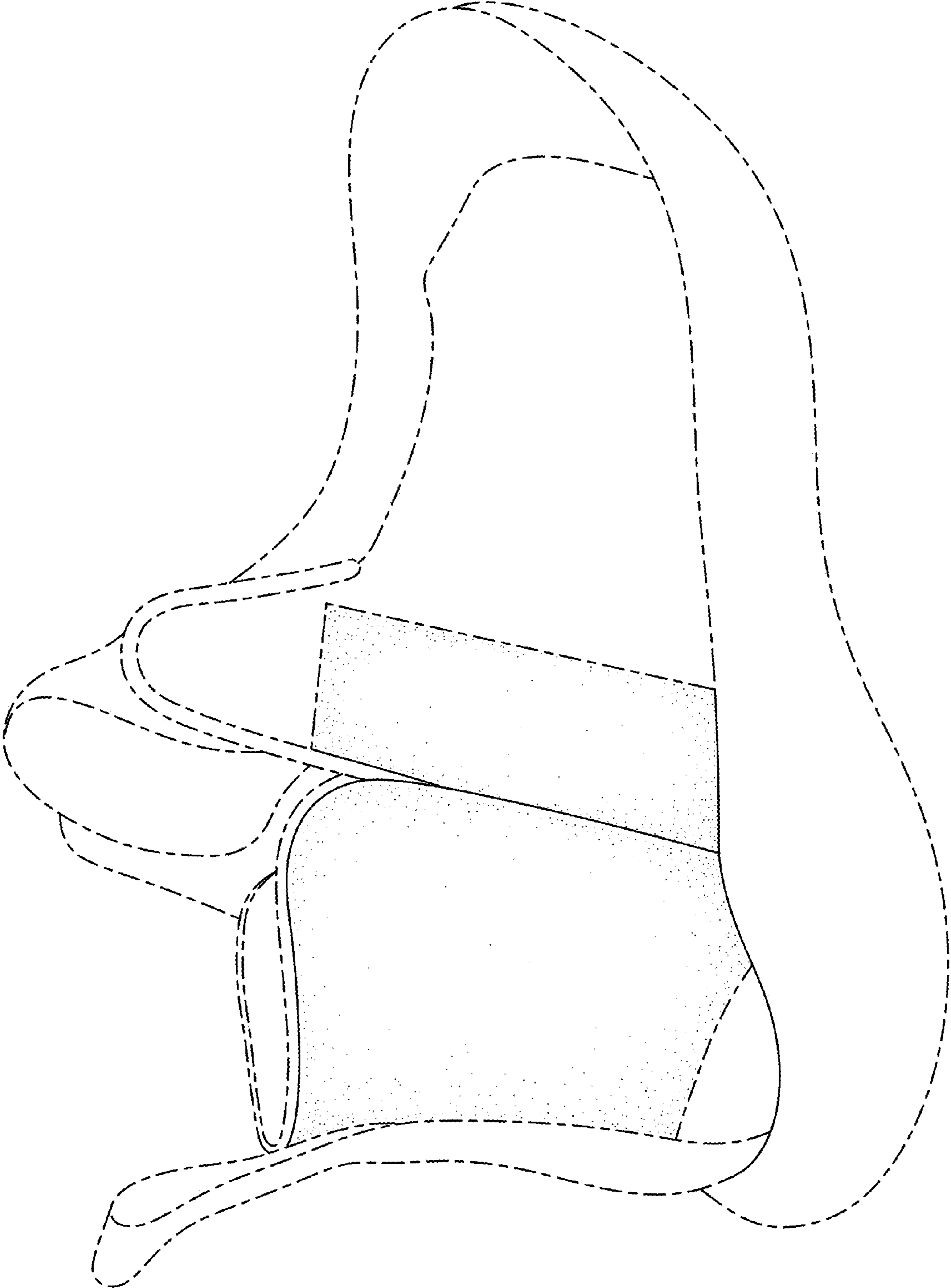

FIG. 3

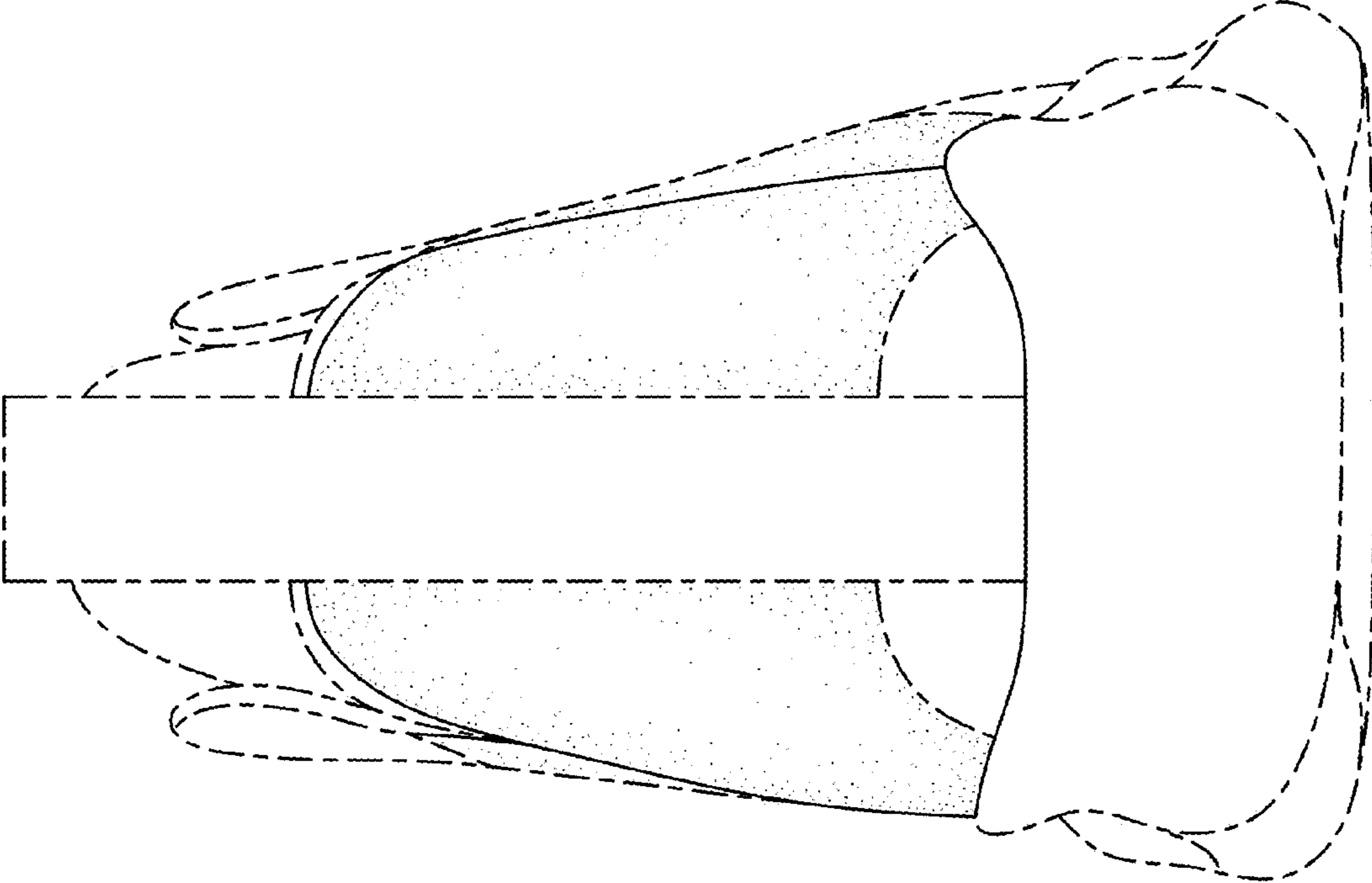

FIG. 4

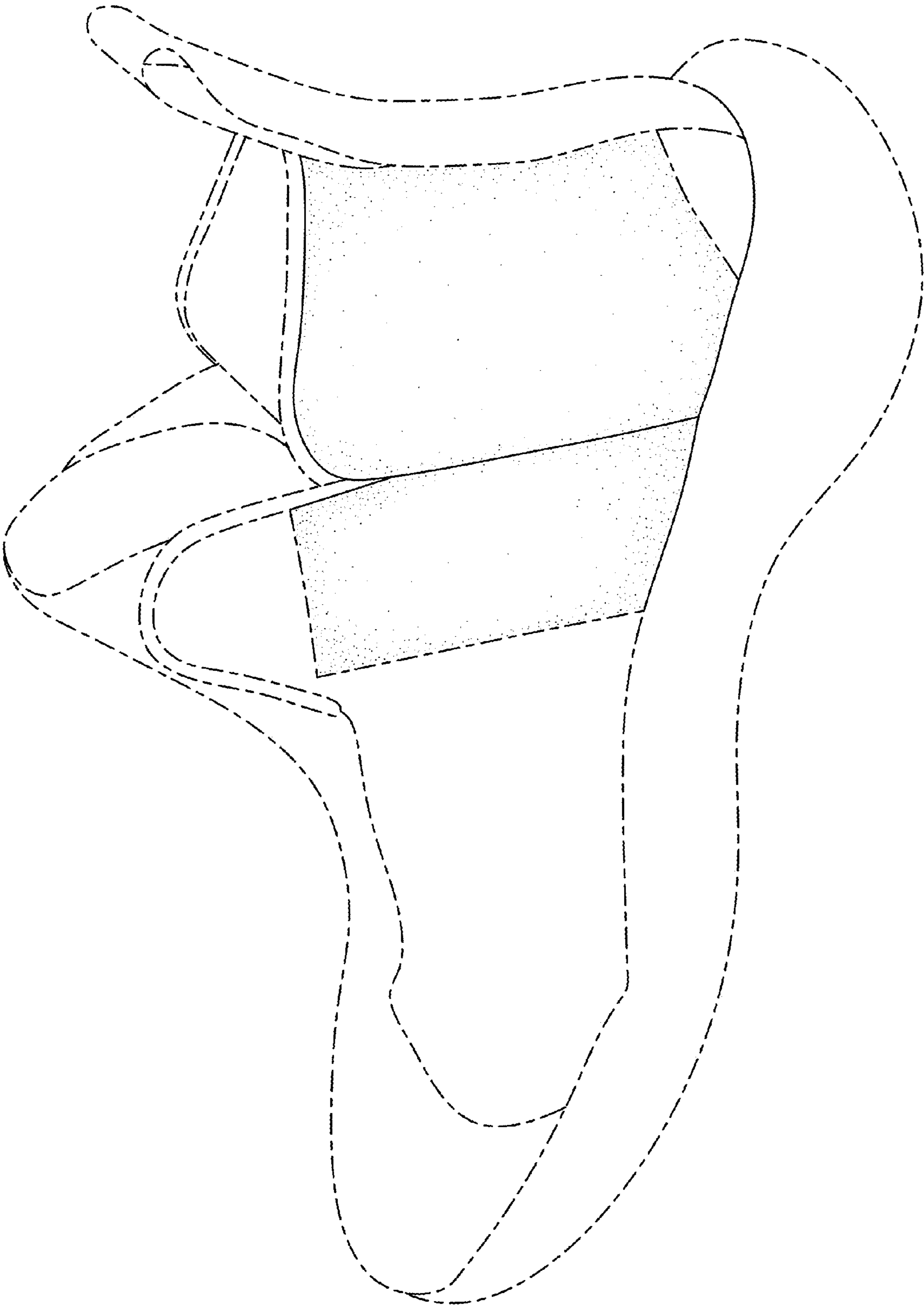

FIG. 5



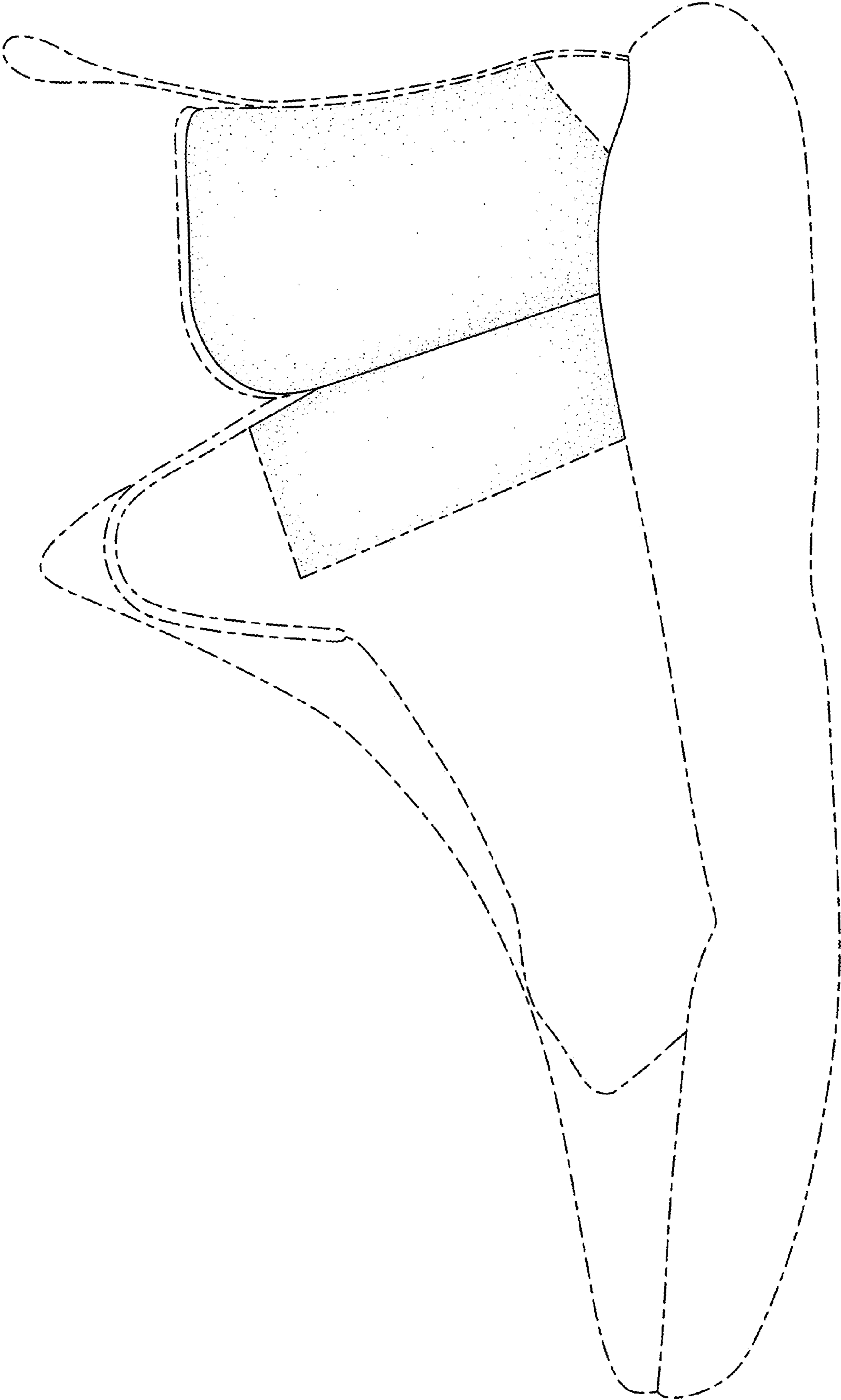

FIG. 6

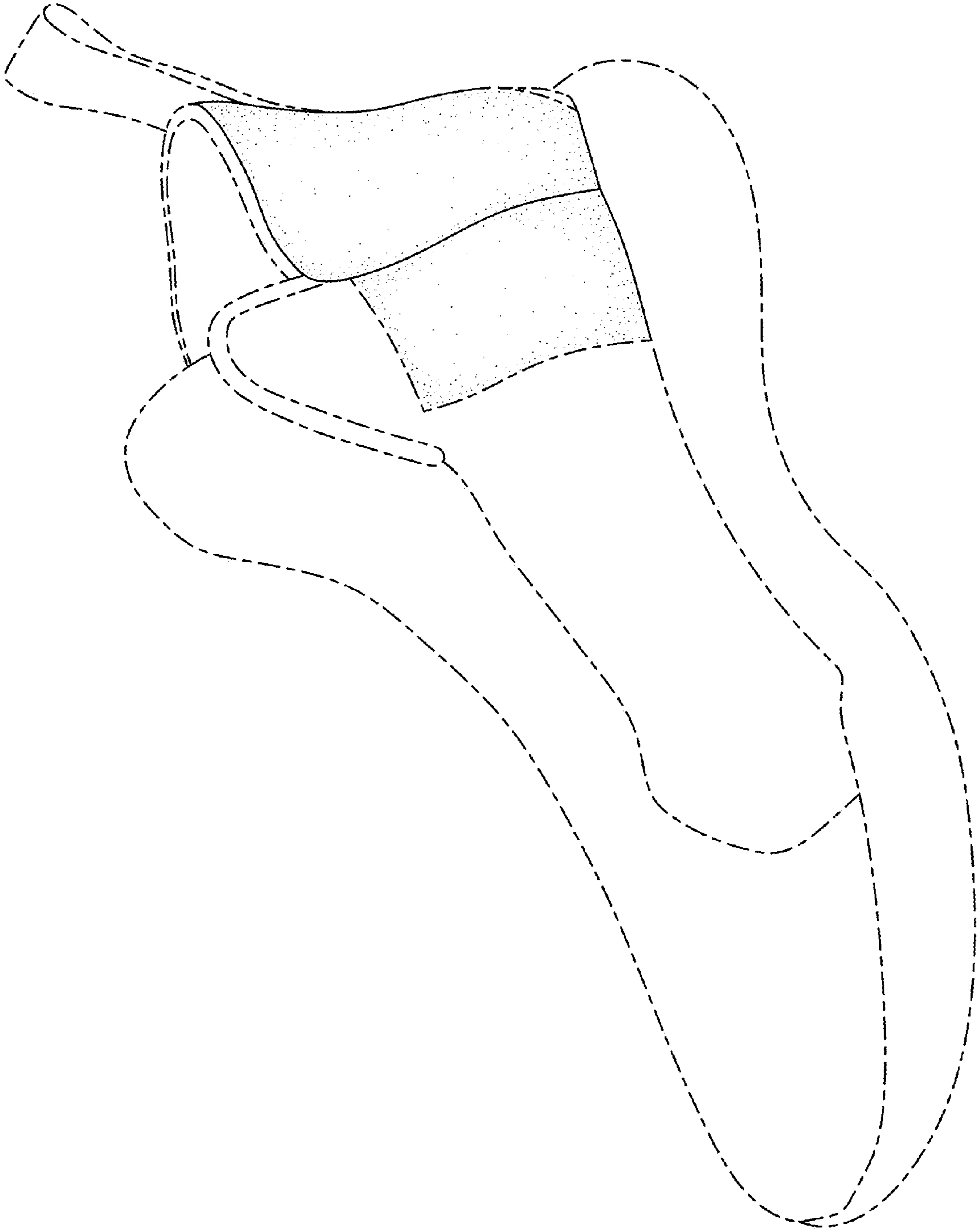

FIG. 7



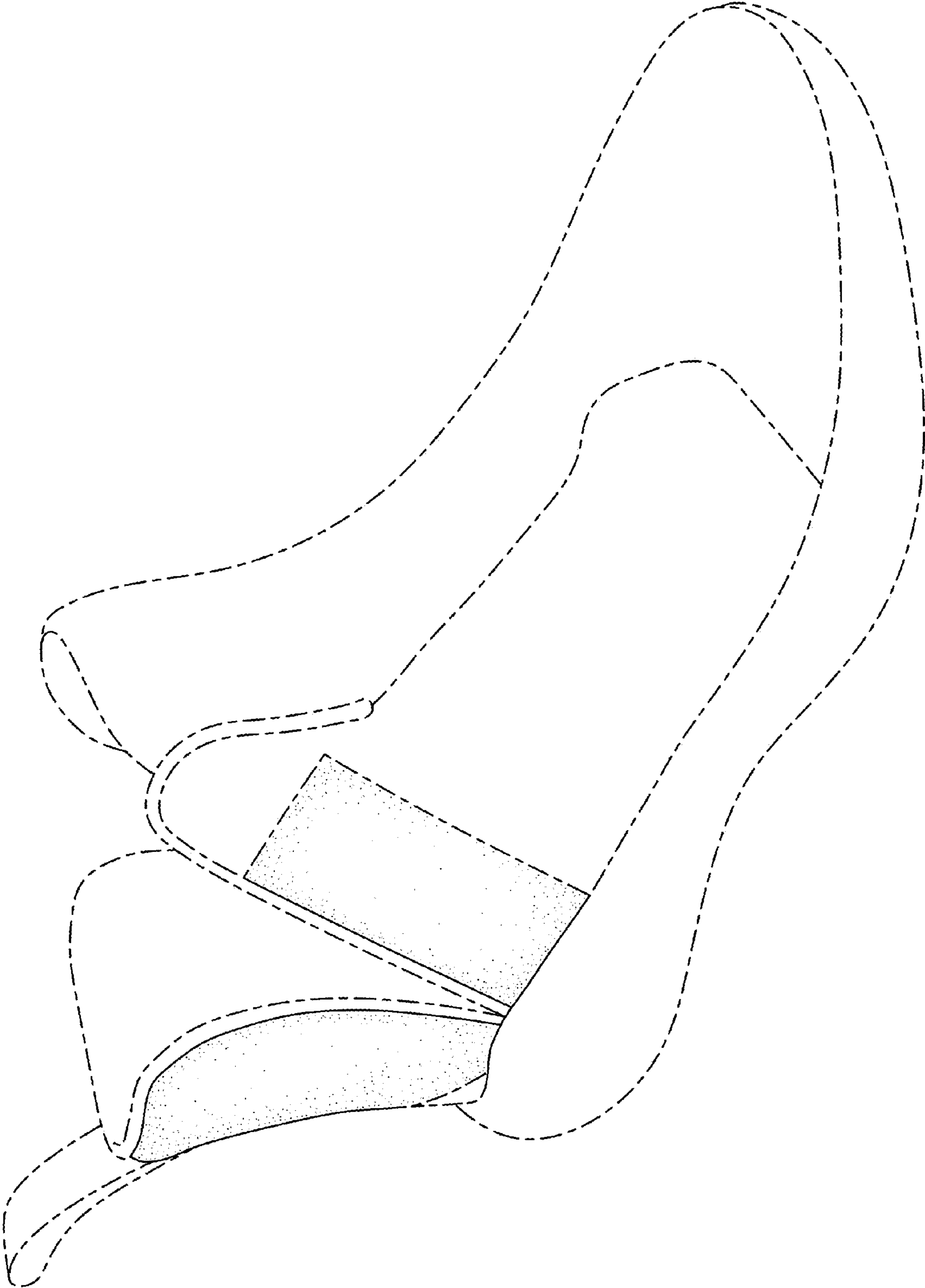

FIG. 8

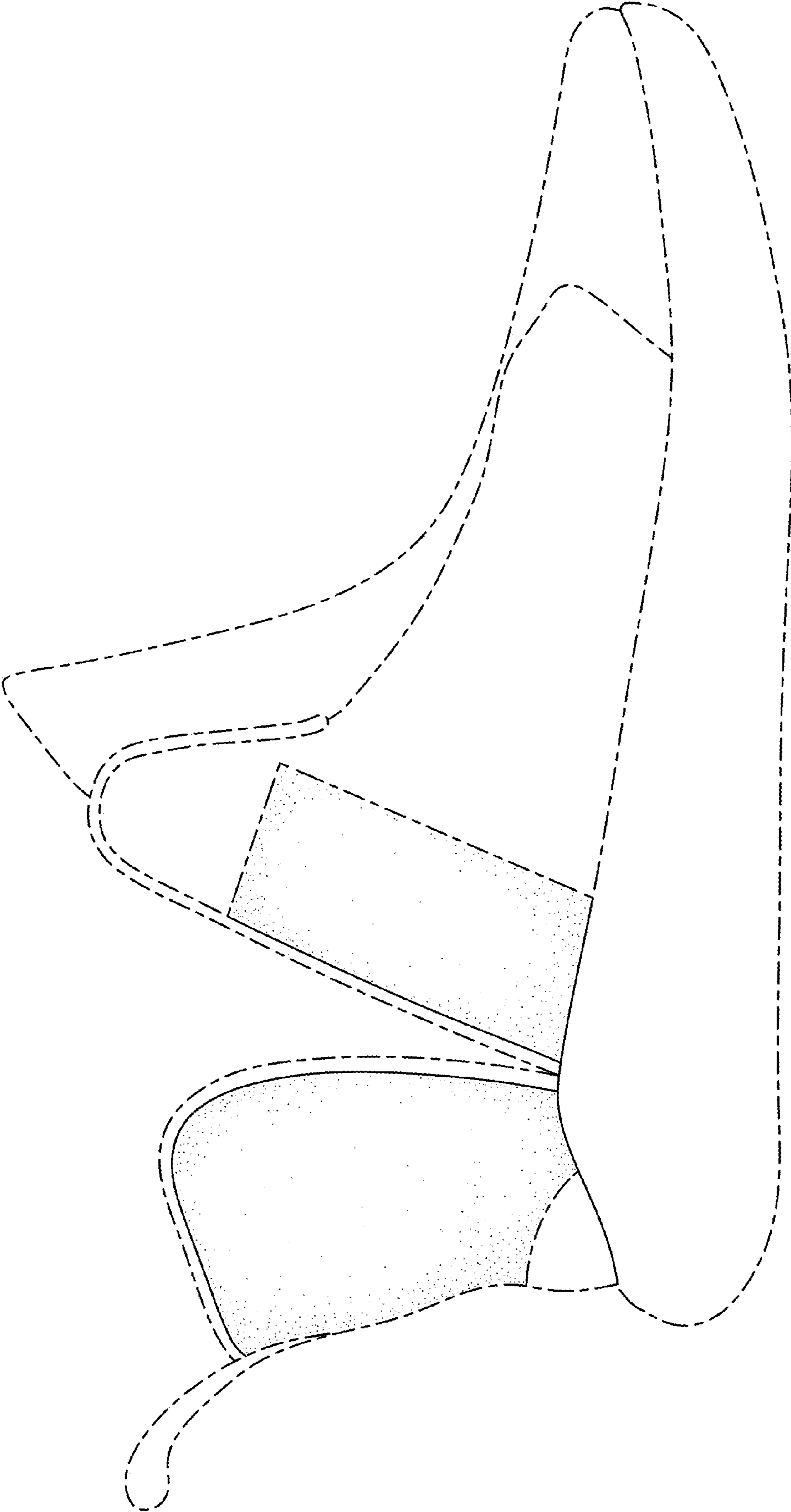

FIG. 9

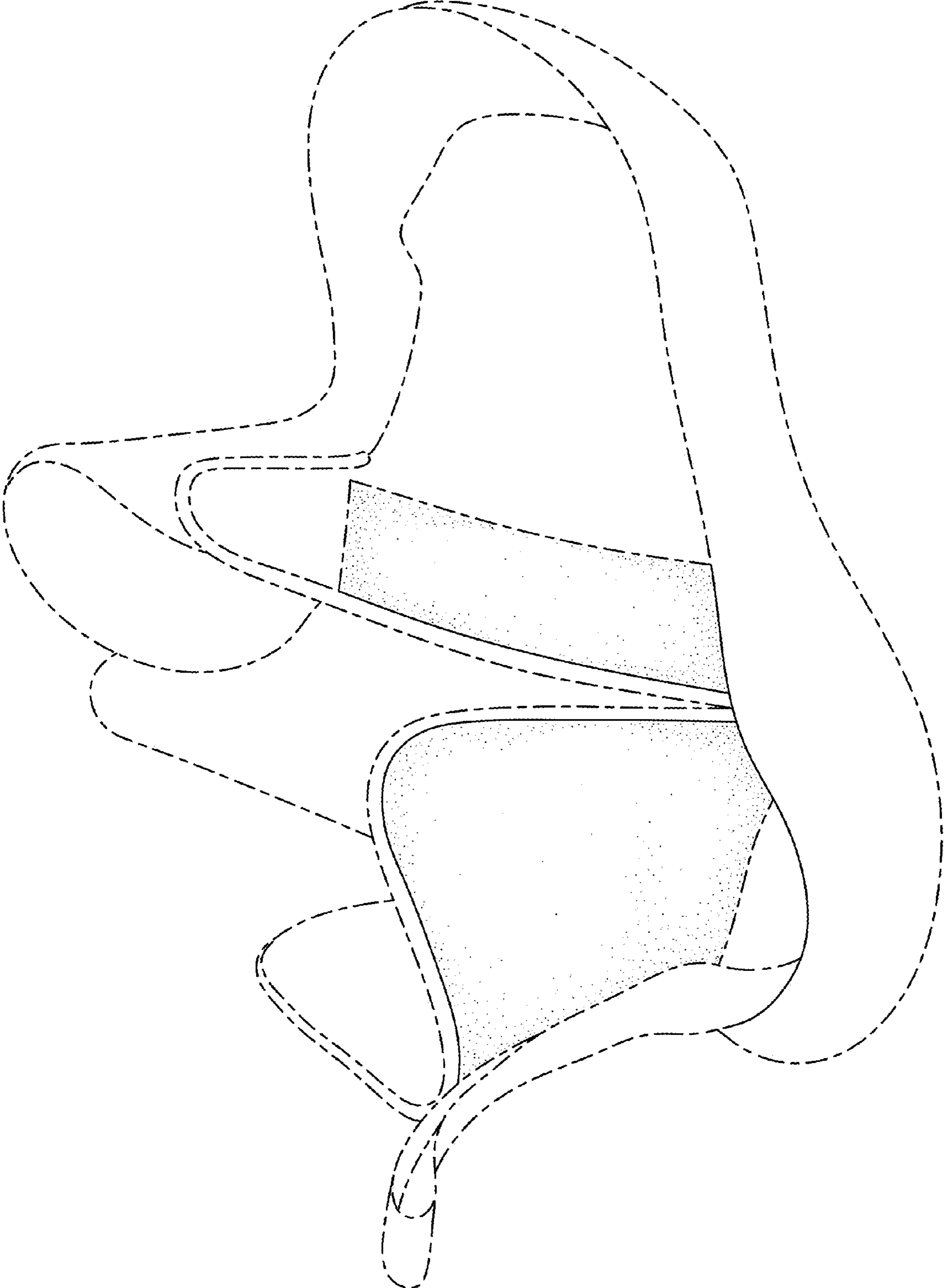

FIG. 10

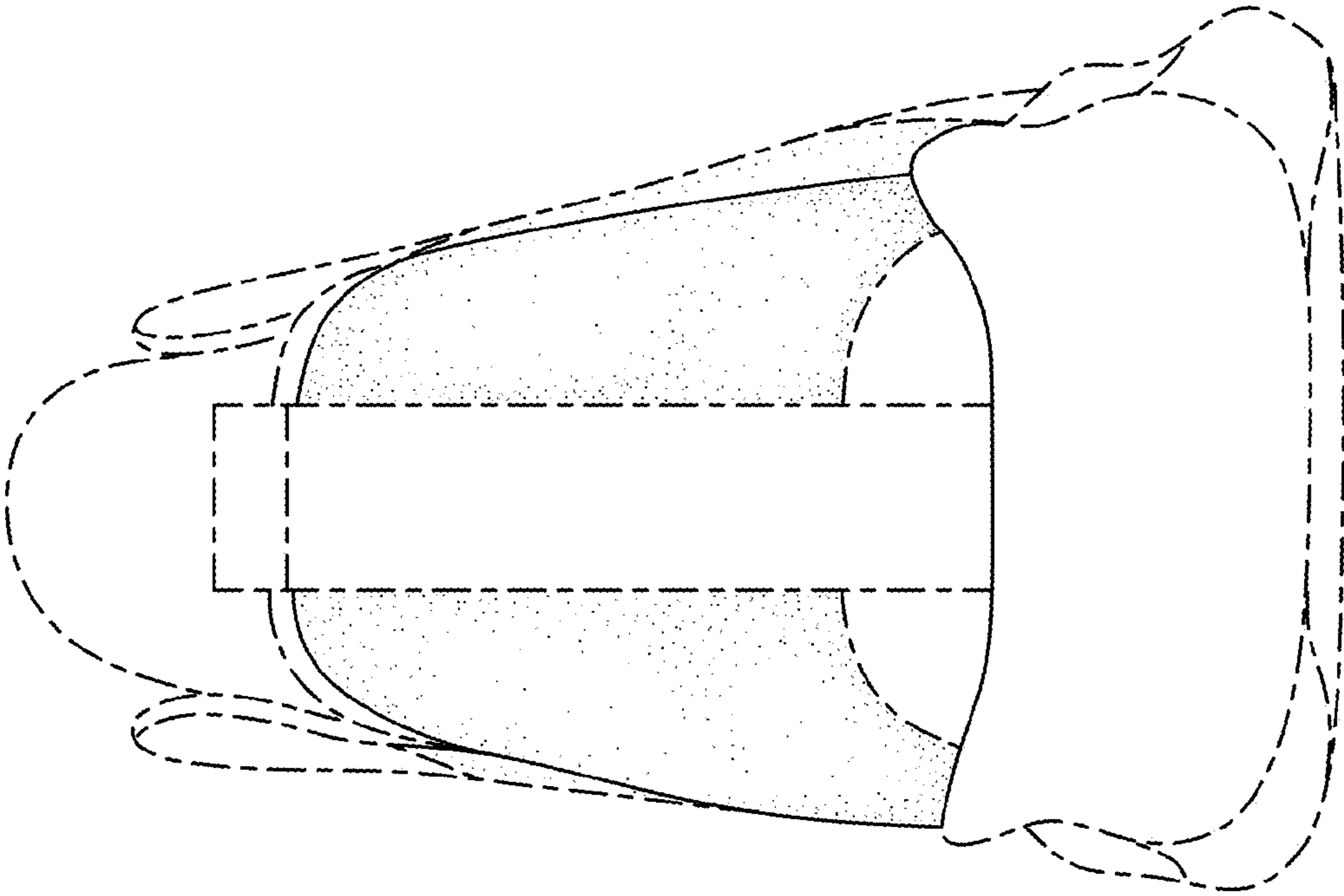

FIG. 11

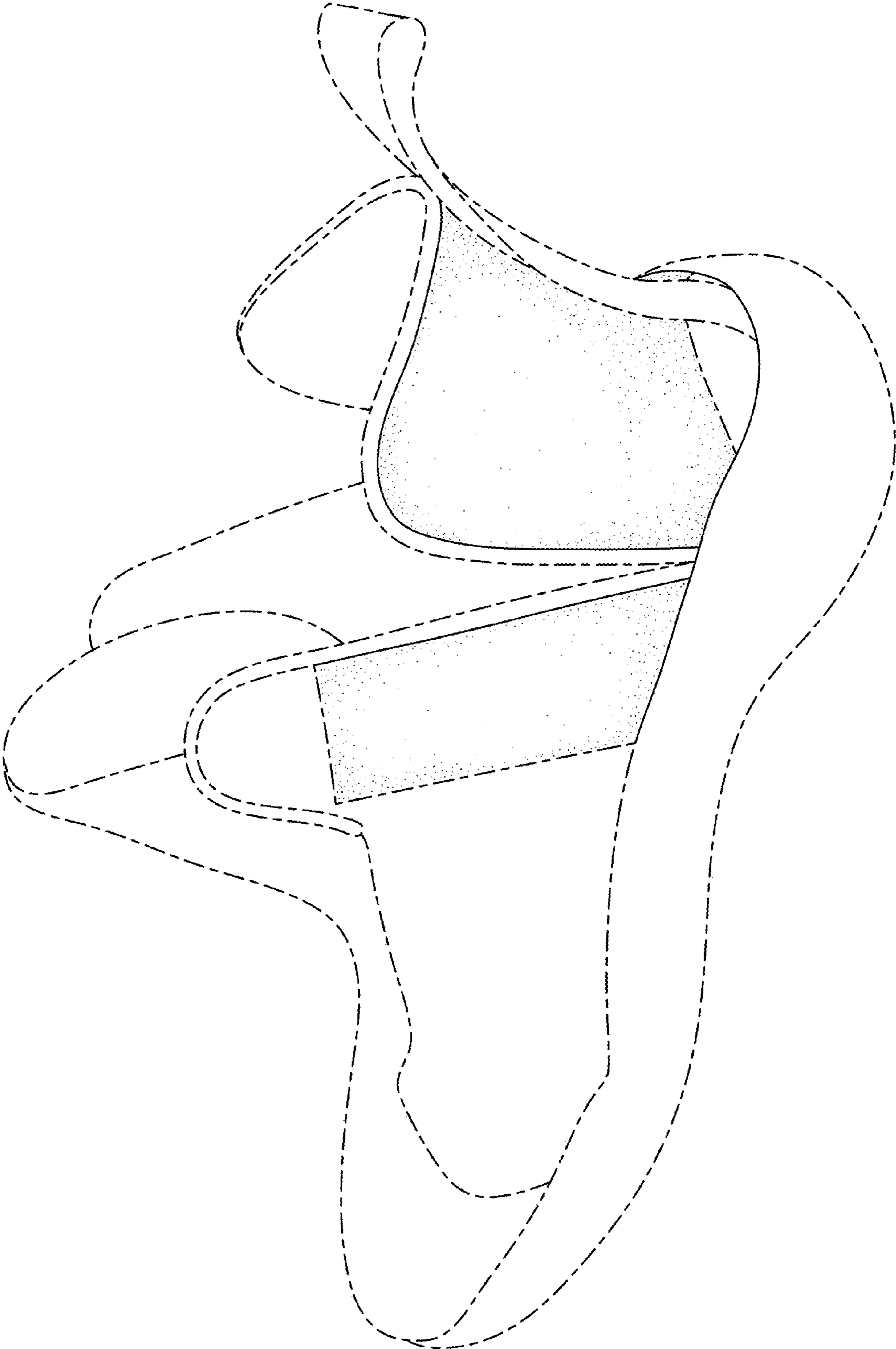

FIG. 12

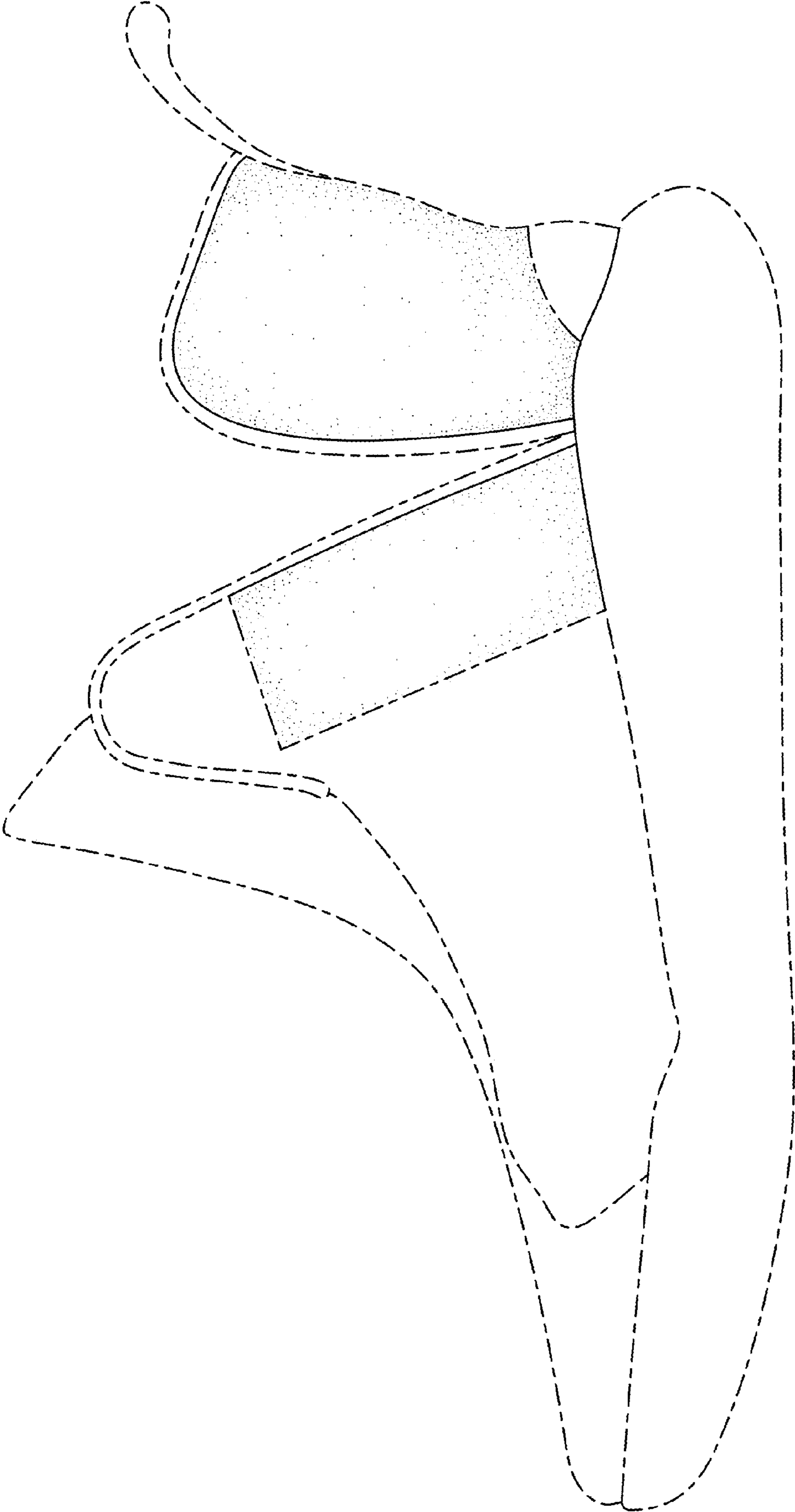

FIG. 13

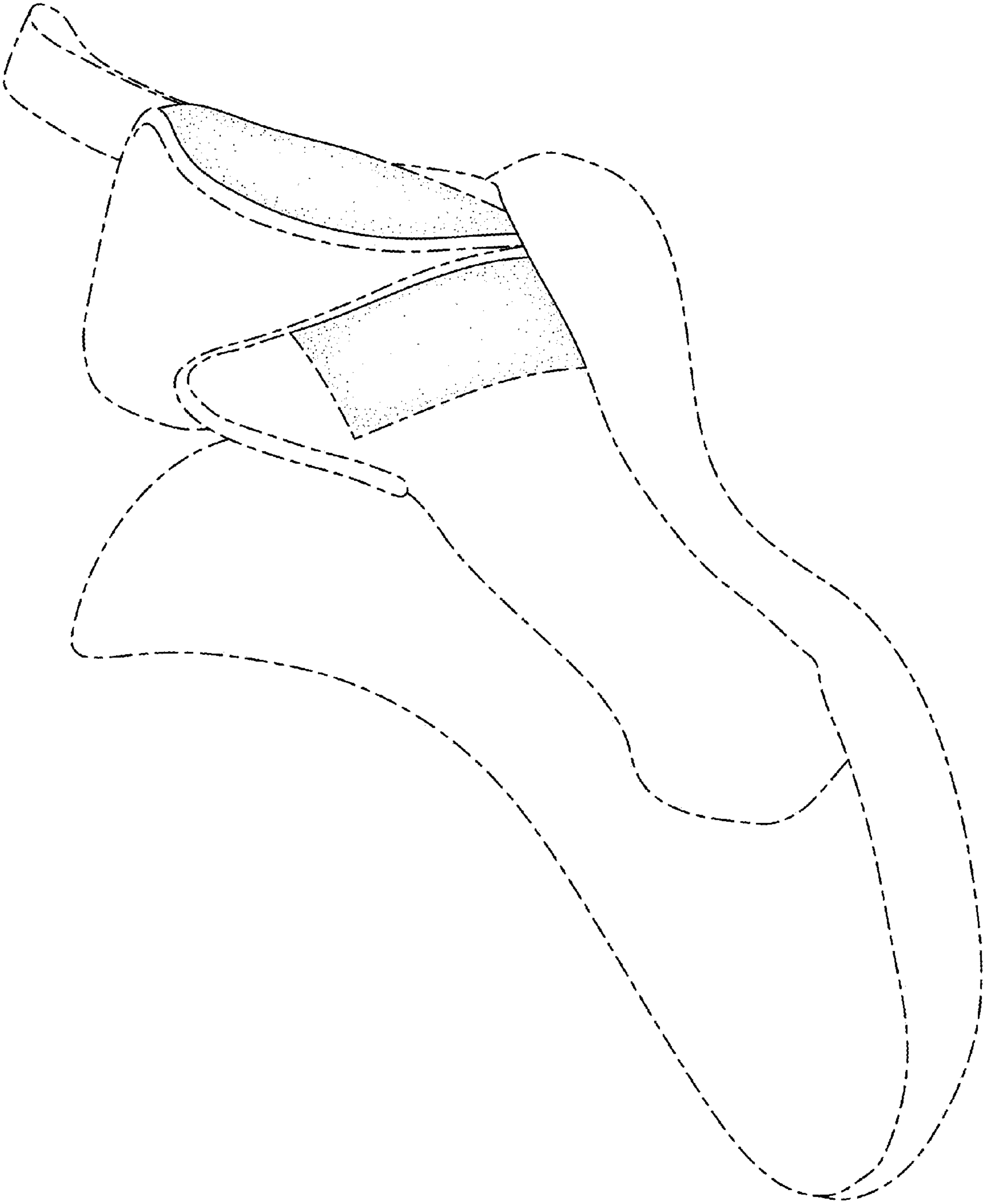

FIG. 14