



US00D879412S

(12) **United States Design Patent**  
**Colbert**

(10) **Patent No.:** **US D879,412 S**  
(45) **Date of Patent:** **\*\* Mar. 31, 2020**

(54) **COMBINATION SCARF AND VEST**

(71) Applicant: **Karl Colbert**, Chicago, IL (US)

(72) Inventor: **Karl Colbert**, Chicago, IL (US)

(\*\*) Term: **15 Years**

(21) Appl. No.: **29/644,960**

(22) Filed: **Apr. 23, 2018**

(51) **LOC (12) Cl.** ..... **02-02**

(52) **U.S. Cl.**

USPC ..... **D2/831; D2/501**

(58) **Field of Classification Search**

USPC ..... D2/501, 750, 759, 828-831, 845, 854,  
D2/865, 602; D29/101.1, 101.4;  
2/91-92, 102, 108; D24/206

CPC . A41D 1/02; A41D 1/04; A41D 23/00; A41D  
31/005; A41D 31/04

See application file for complete search history.

(56) **References Cited**

**U.S. PATENT DOCUMENTS**

2,269,491	A *	1/1942	Snyder	.....	A41D 1/04 2/90
D139,536	S *	11/1944	Baurer	.....	D2/829
4,495,660	A *	1/1985	Hayden	.....	A41D 23/00 2/91
4,620,324	A *	11/1986	Parr	.....	A41D 23/00 2/91
D304,257	S *	10/1989	Dorning	.....	D2/854
D588,339	S *	3/2009	Dudzik	.....	D2/826
D698,523	S *	2/2014	Roberts	.....	D2/829
D703,922	S *	5/2014	Roberts	.....	D2/829
D713,997	S *	9/2014	Daugherty	.....	D29/101.4
D762,348	S *	8/2016	Harris	.....	D2/854
D779,165	S *	2/2017	Valente	.....	D2/854
D791,441	S *	7/2017	Van Sisseren	.....	D2/828
D851,775	S *	6/2019	Jordanov	.....	D24/206

\* cited by examiner

*Primary Examiner* — Barbara Fox

*Assistant Examiner* — J. Thorn, Sr.

(74) *Attorney, Agent, or Firm* — Lesley A. Wallerstein, LLC

(57) **CLAIM**

The ornamental design for a combination scarf and vest, as shown and described.

**DESCRIPTION**

FIG. 1 is a front view of a combination scarf and vest according to the present invention.

FIG. 2 is a back view of the combination scarf and vest of FIG. 1.

FIG. 3 is a first right side view of the combination scarf and vest of FIG. 1. The combination scarf and vest of FIG. 1 also has a first left side view, not illustrated, which is a mirror image of the right side.

FIG. 4 is a second right side view of the combination scarf and vest of FIG. 1. The combination scarf and vest of FIG. 1 also has a second left side view, not illustrated, which is a mirror image of the alternative right side view.

FIG. 5 is an exploded, deconstructed and flat view of the combination scarf and vest of FIG. 1.

FIG. 6 is a top view of the combination scarf and vest of FIG. 1, shown separate from the person.

FIG. 7 is a top view of the combination scarf and vest of FIG. 1, shown worn on a person; and,

FIG. 8 is a bottom view of the combination scarf and vest of FIG. 6.

The broken line showing of the person depicts environment and forms no part of the claimed design.

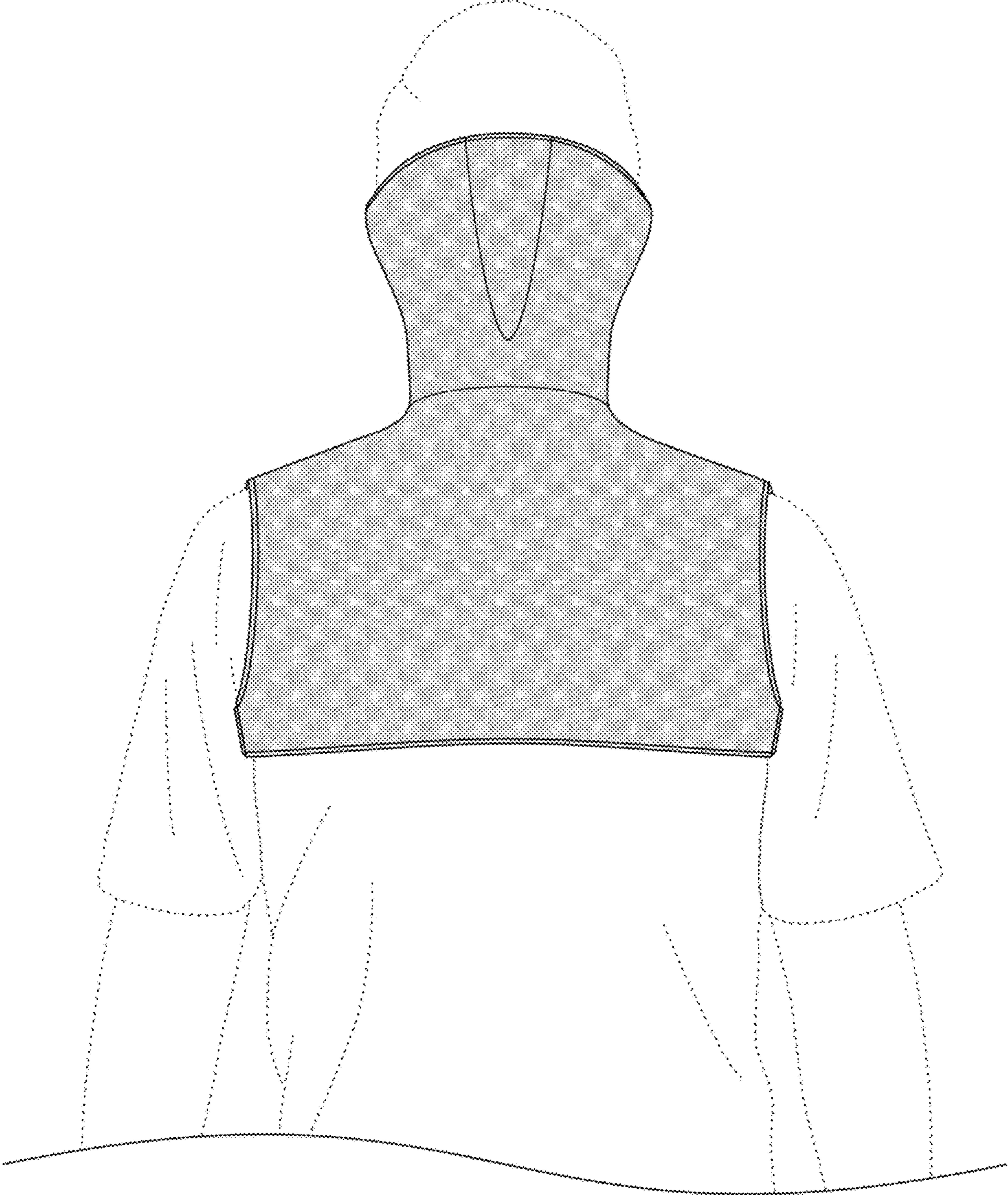
**1 Claim, 7 Drawing Sheets**



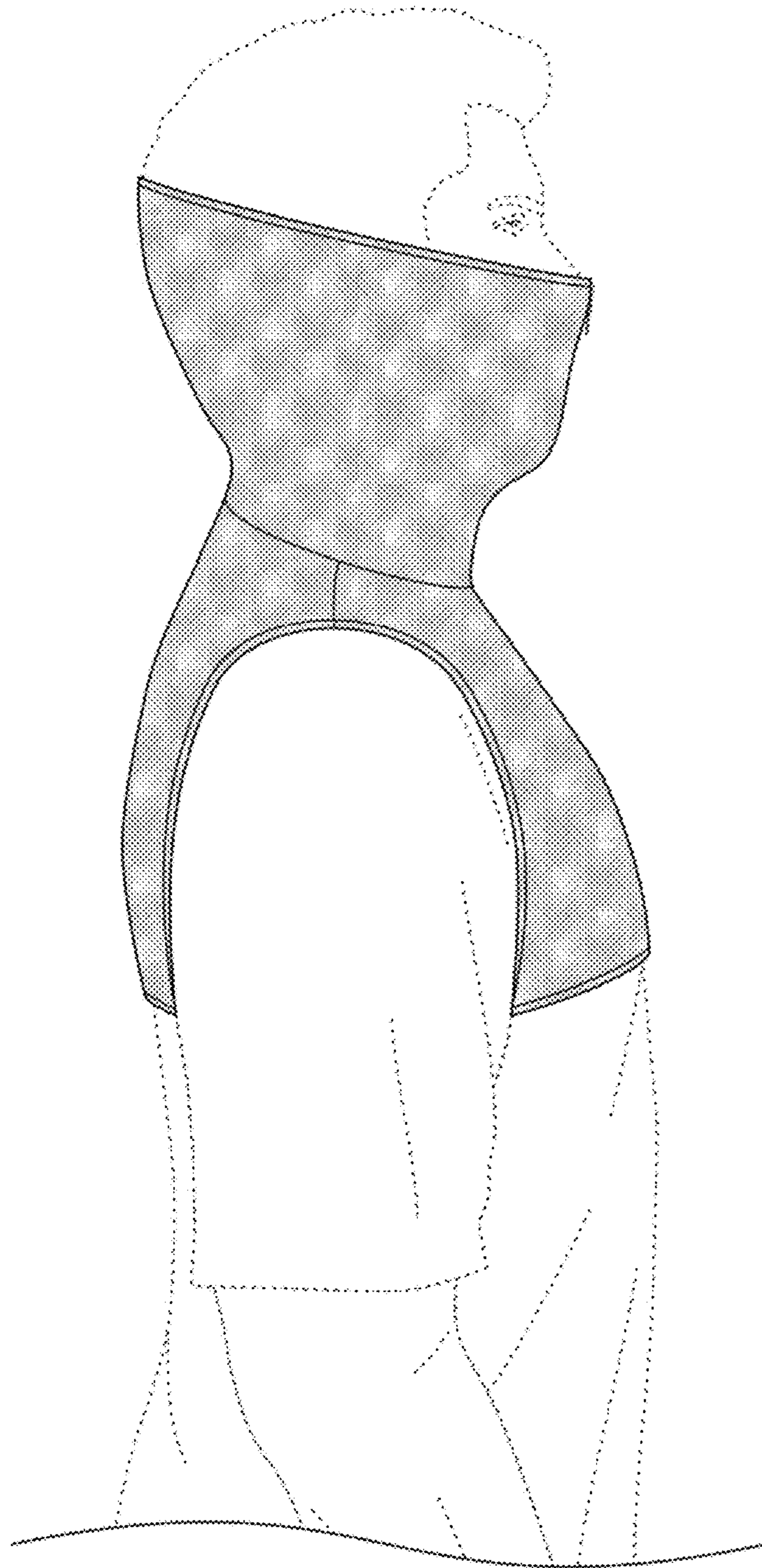


**FIG. 1**



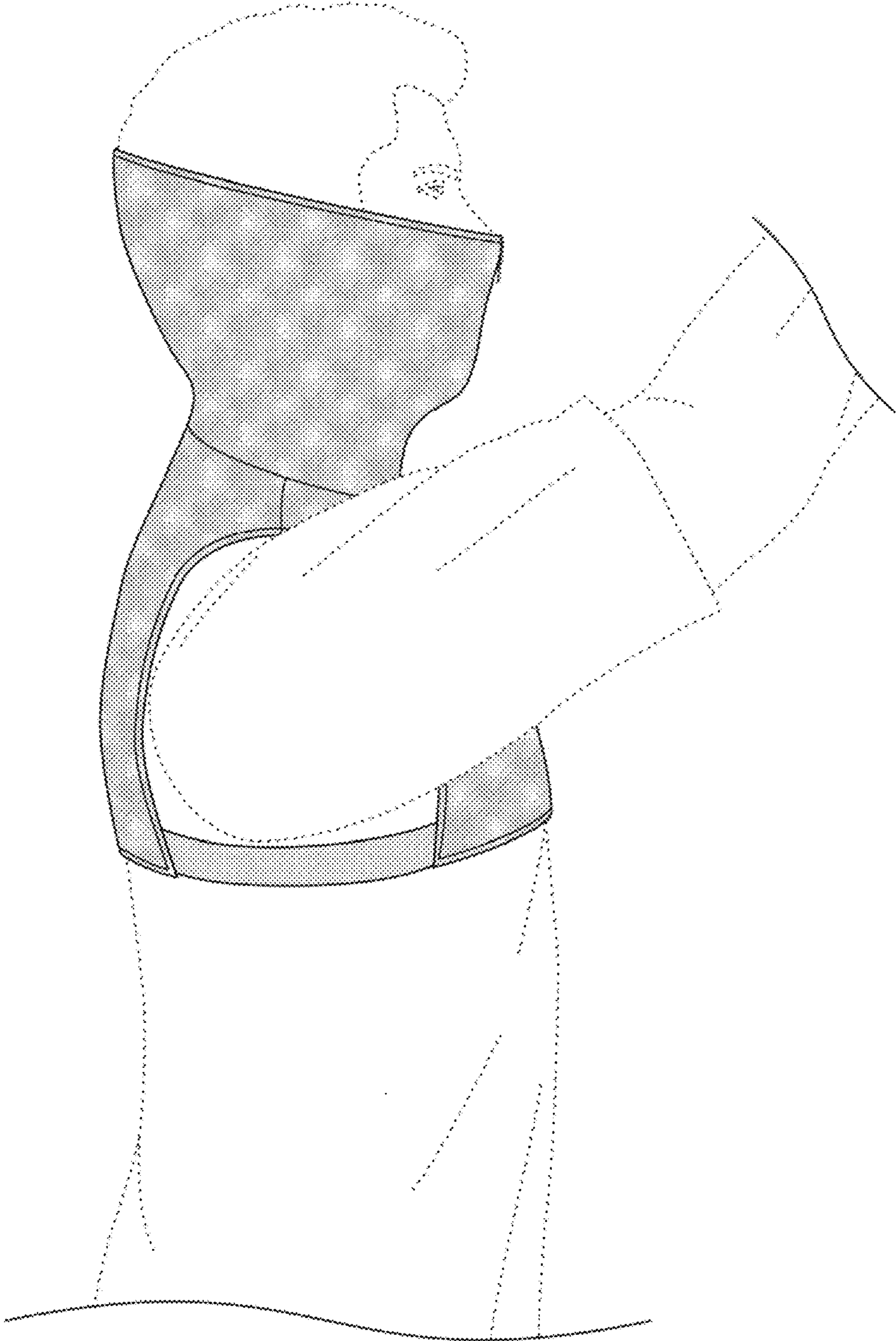


**FIG. 2**



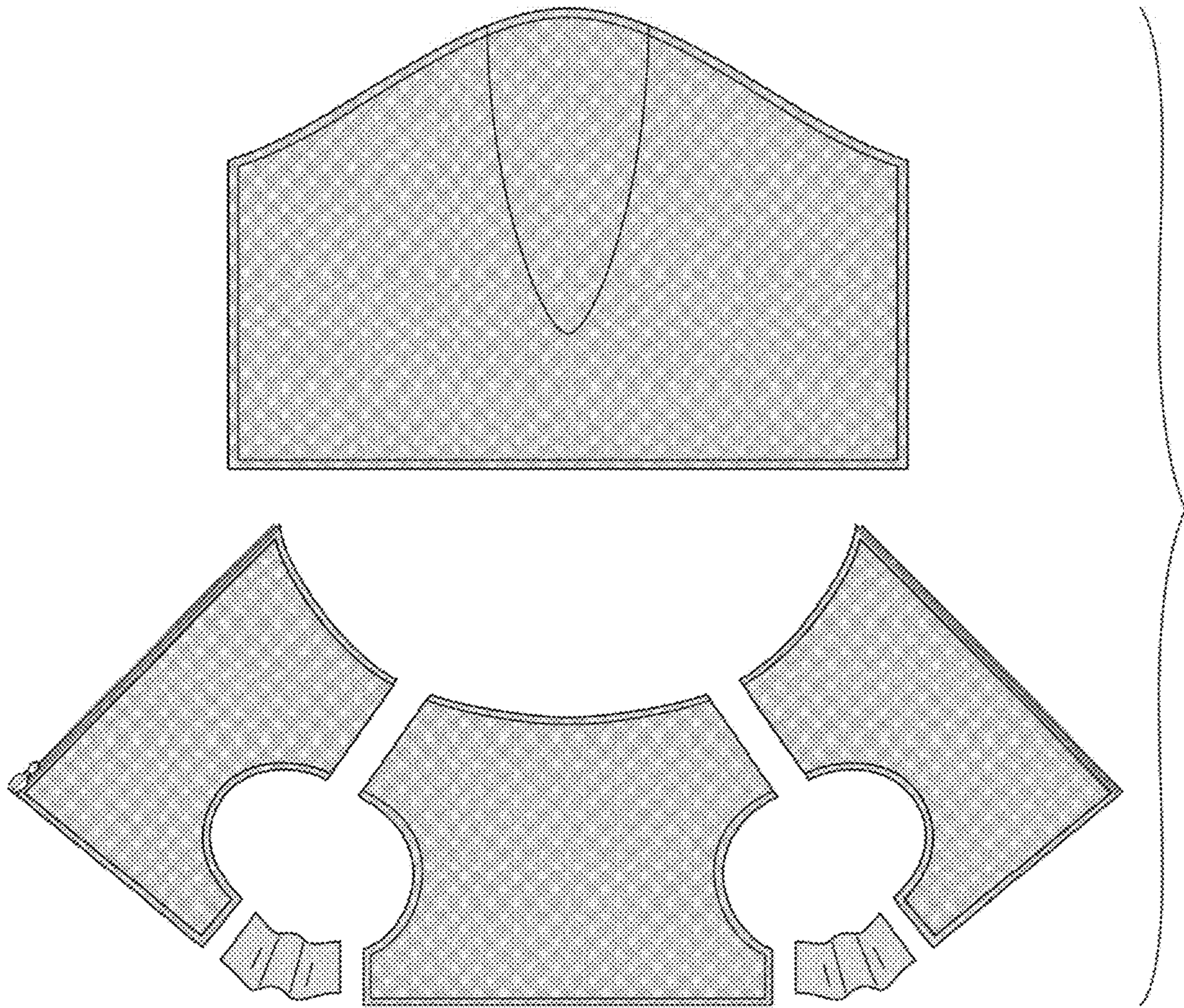
**FIG. 3**





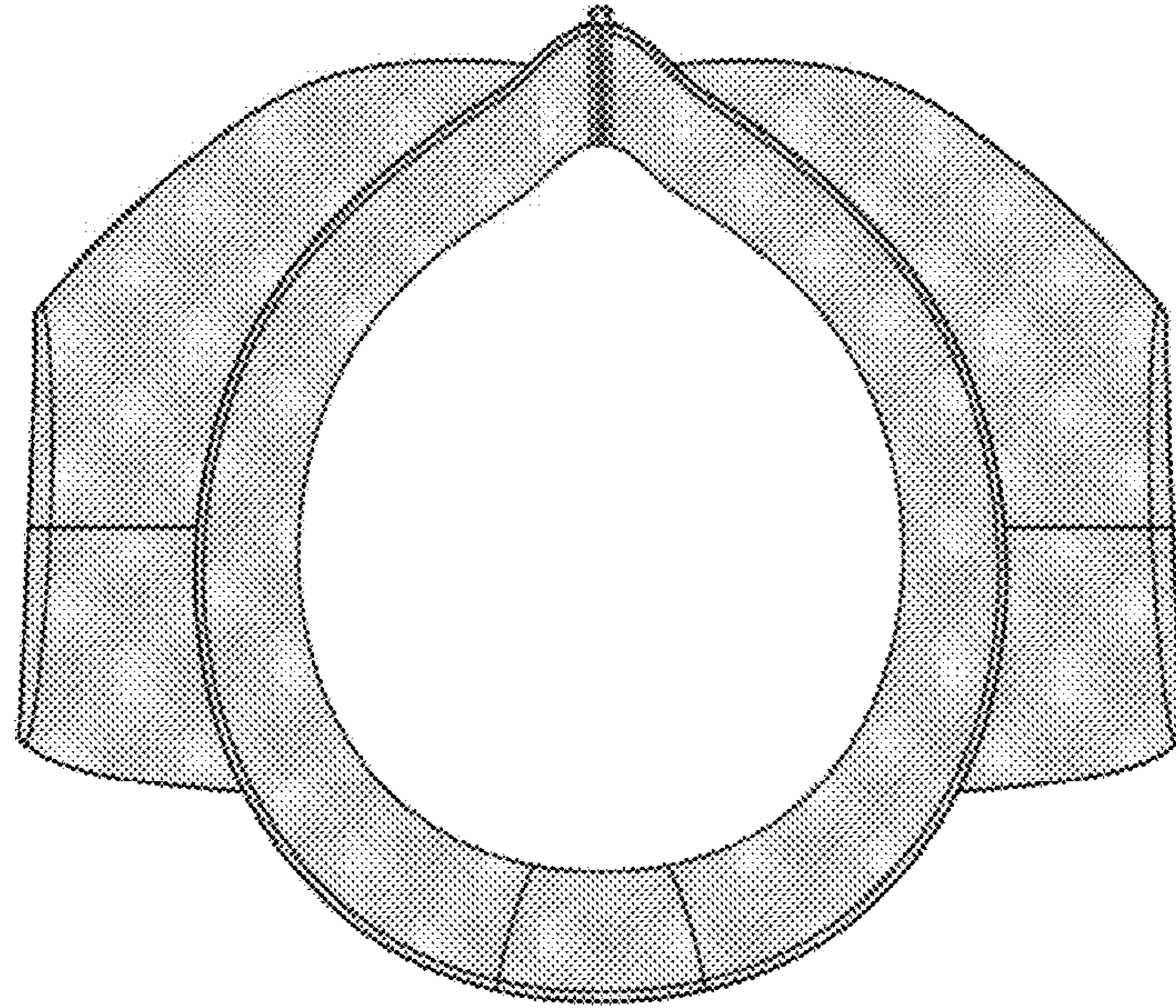
**FIG. 4**



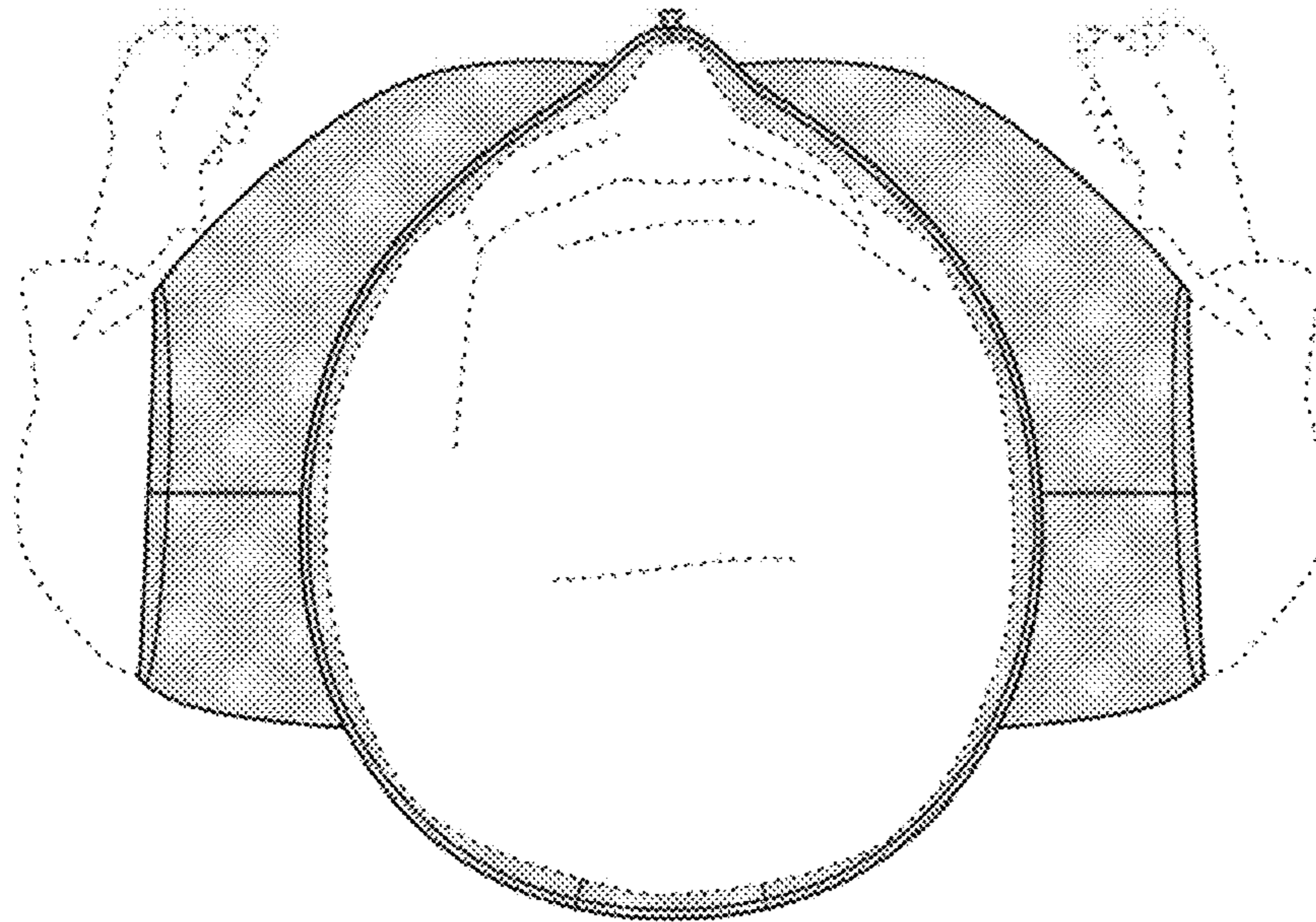


**FIG. 5**

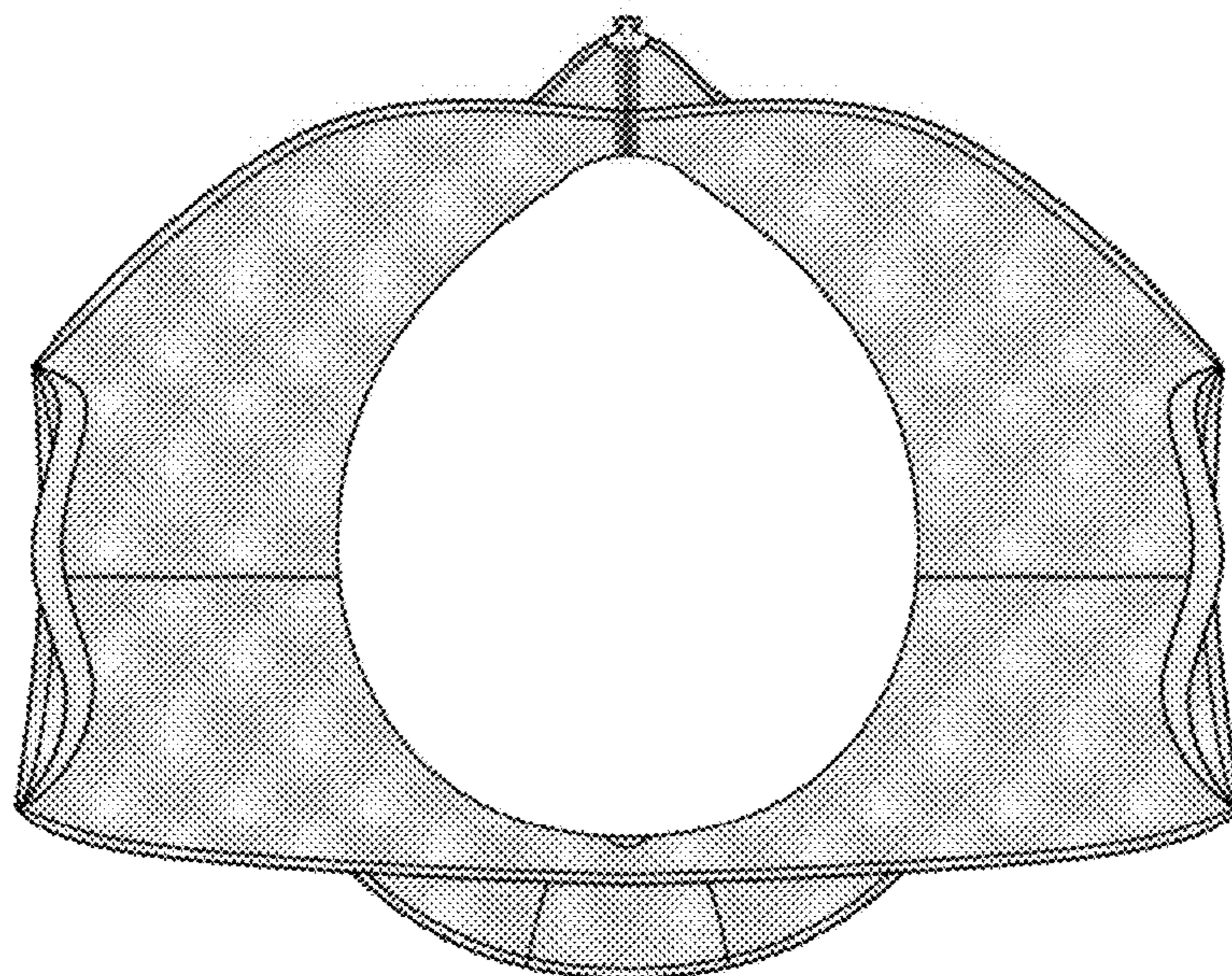




**FIG. 6**



**FIG. 7**



**FIG. 8**