



US00D879374S

(12) **United States Design Patent**
Liao

(10) **Patent No.:** **US D879,374 S**
(45) **Date of Patent:** **** Mar. 24, 2020**

- (54) **HAIR DRYER BRUSH**
- (71) Applicant: **Dongguan Shengming Industrial Co., Ltd**, Dongguan, Guangdong (CN)
- (72) Inventor: **Shengwang Liao**, Jiangxi (CN)
- (**) Term: **15 Years**
- (21) Appl. No.: **29/696,479**
- (22) Filed: **Jun. 27, 2019**
- (51) **LOC (12) Cl.** **28-03**
- (52) **U.S. Cl.**
USPC **D28/13**
- (58) **Field of Classification Search**
USPC D28/12-19; D4/128, 133
CPC A45D 20/00; A45D 20/08; A45D 20/50;
A45D 20/52
See application file for complete search history.

- 7,814,602 B2 * 10/2010 Stydahr A46B 7/10
132/120
- D776,345 S * 1/2017 Tang D28/13
- D821,648 S 6/2018 Qiu
- D842,538 S 3/2019 Rosenzweig

* cited by examiner

Primary Examiner — Zenia I Bennett
(74) *Attorney, Agent, or Firm* — Jie Yang; ZANIP

(57) **CLAIM**

The ornamental design for a hair dryer brush, as shown and described.

DESCRIPTION

FIG. 1 is a first perspective view of a hair dryer brush showing my design;
 FIG. 2 is a second perspective view thereof;
 FIG. 3 is a front view thereof;
 FIG. 4 is a back view thereof;
 FIG. 5 is a left side view thereof;
 FIG. 6 is a right side view thereof;
 FIG. 7 is top view thereof;
 FIG. 8 is a bottom view thereof;
 FIG. 9 is an enlarged view of the selected portion in FIG. 1; and,
 FIG. 10 is an enlarged view of the selected portion in FIG. 1.

The broken lines shown in the drawings depict portions of the hair dryer brush in which the design is embodied that form no part of the claimed design.

(56) **References Cited**

U.S. PATENT DOCUMENTS

- D383,245 S * 9/1997 Seifert D28/13
- D388,538 S 12/1997 Kip
- D430,348 S * 8/2000 Moreno D28/18
- 6,363,215 B1 * 3/2002 Cafaro A45D 20/50
132/118
- D471,718 S * 3/2003 Park D4/133
- D557,018 S * 12/2007 Park D4/128

1 Claim, 10 Drawing Sheets

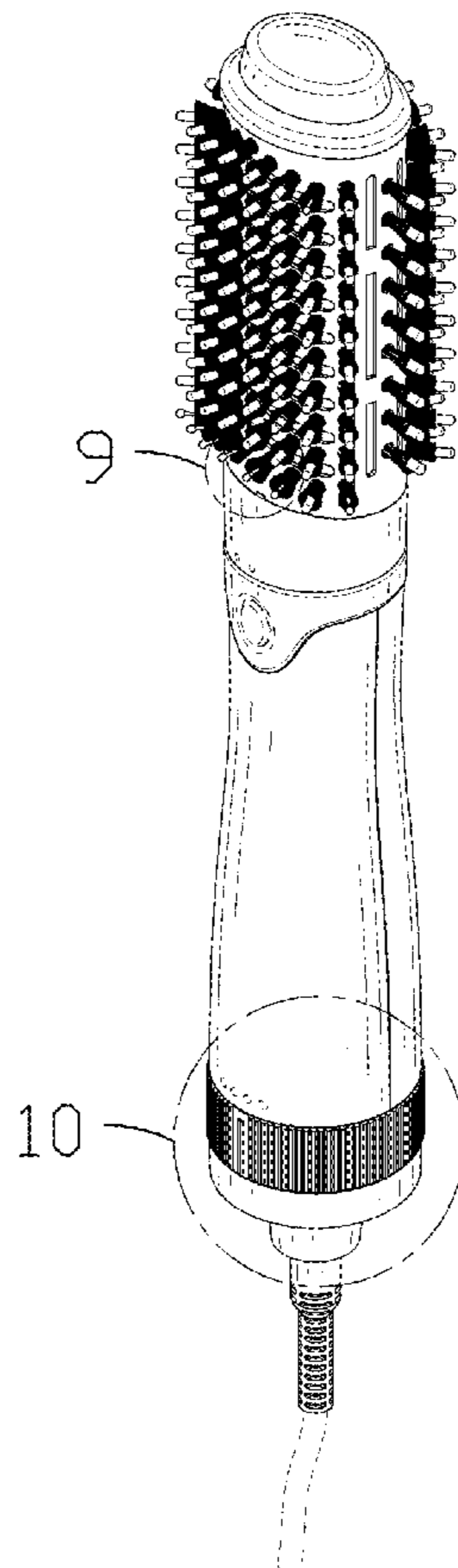

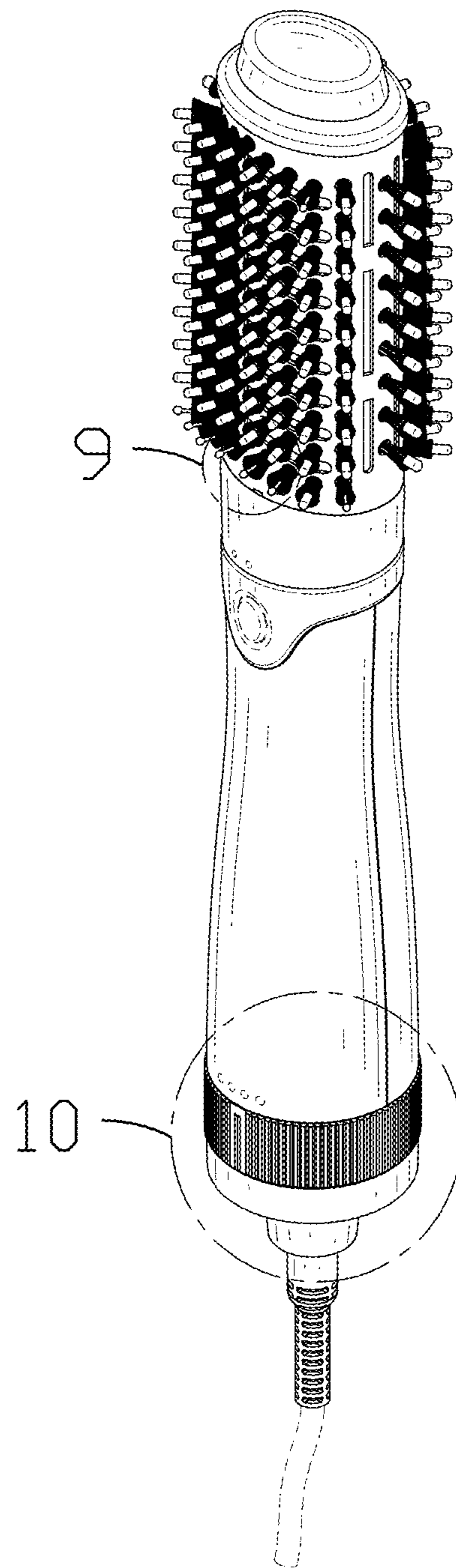

FIG. 1

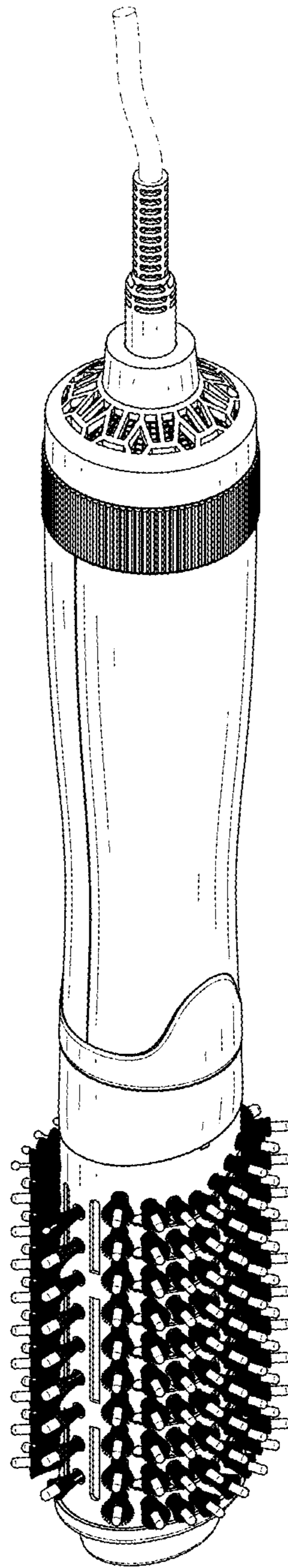

FIG. 2

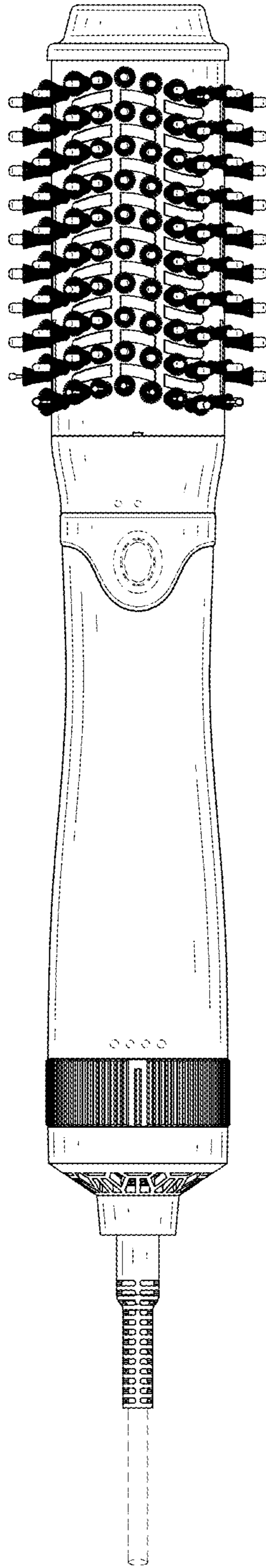

FIG. 3

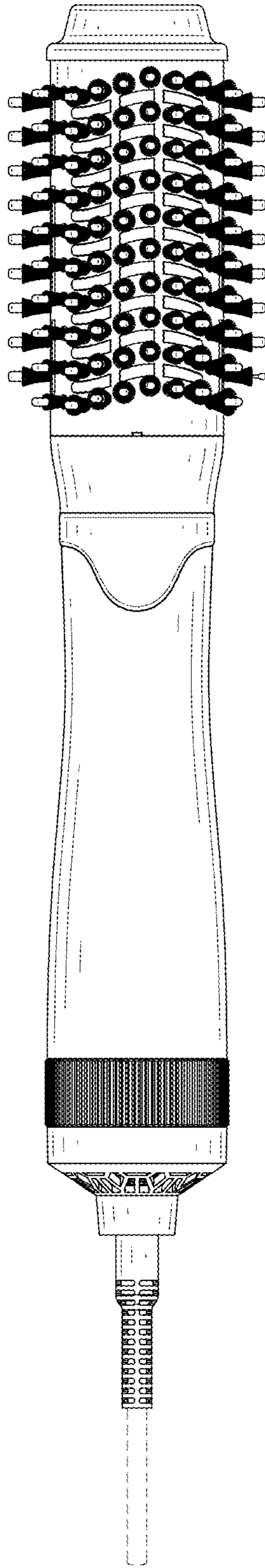

FIG. 4

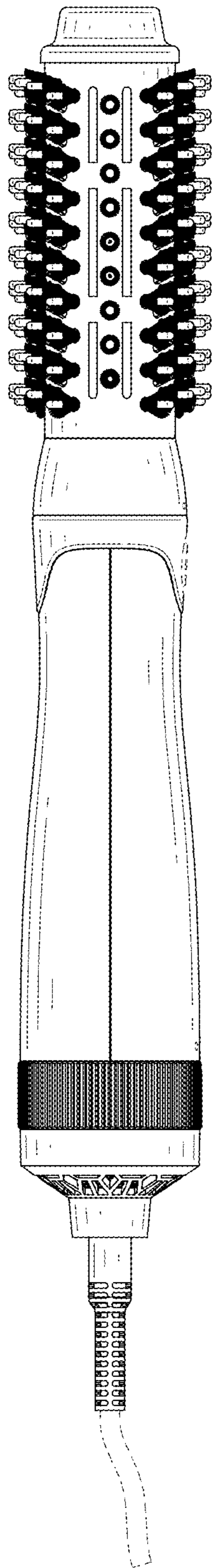

FIG. 5

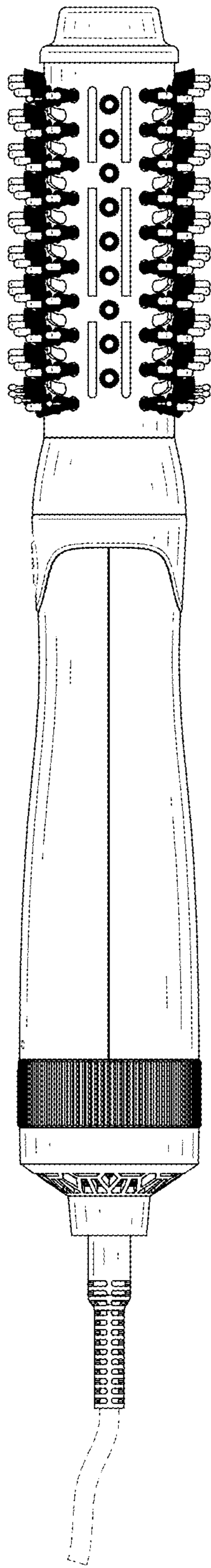

FIG. 6

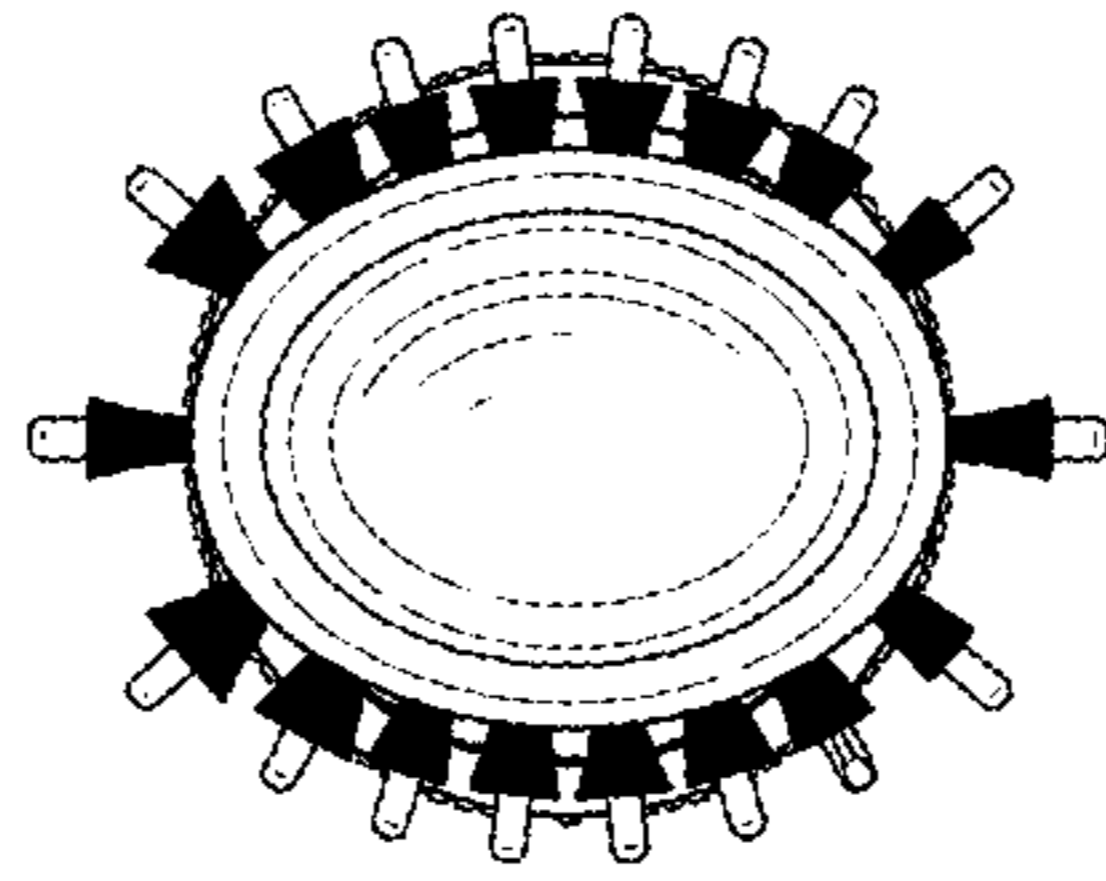

FIG. 7

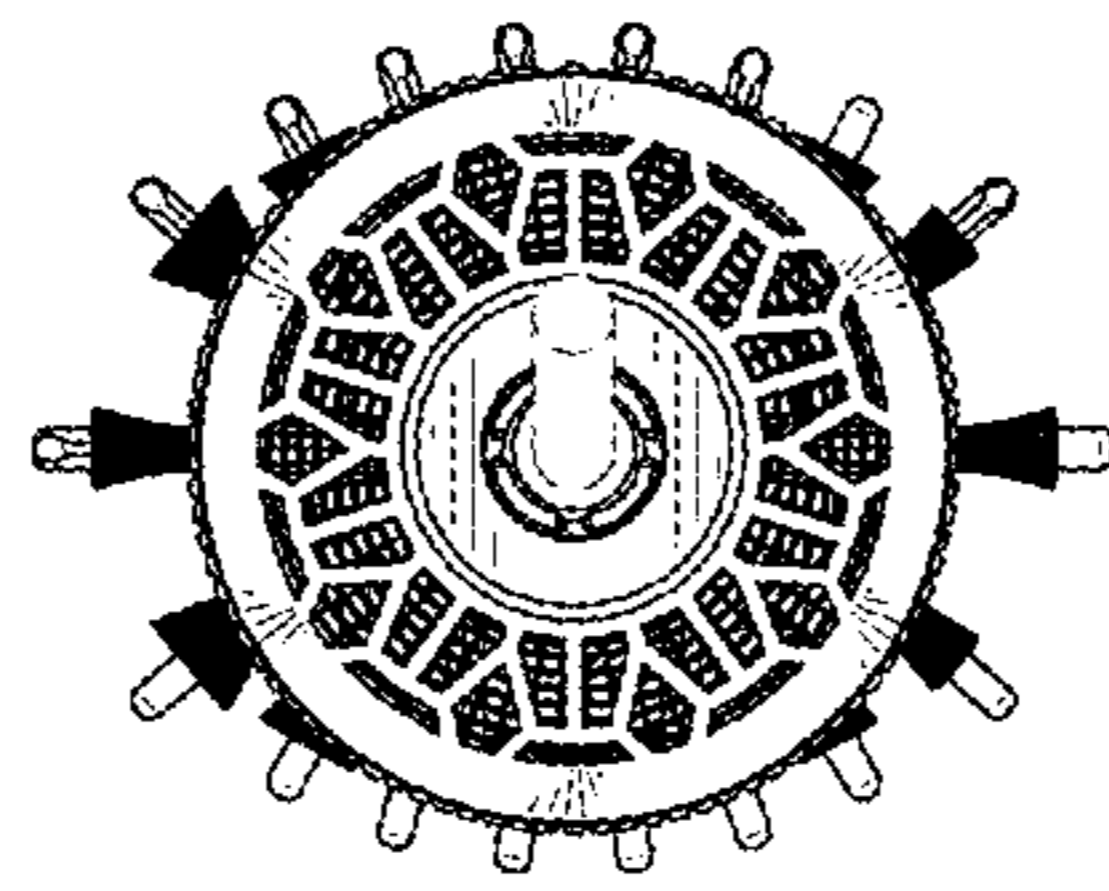

FIG. 8

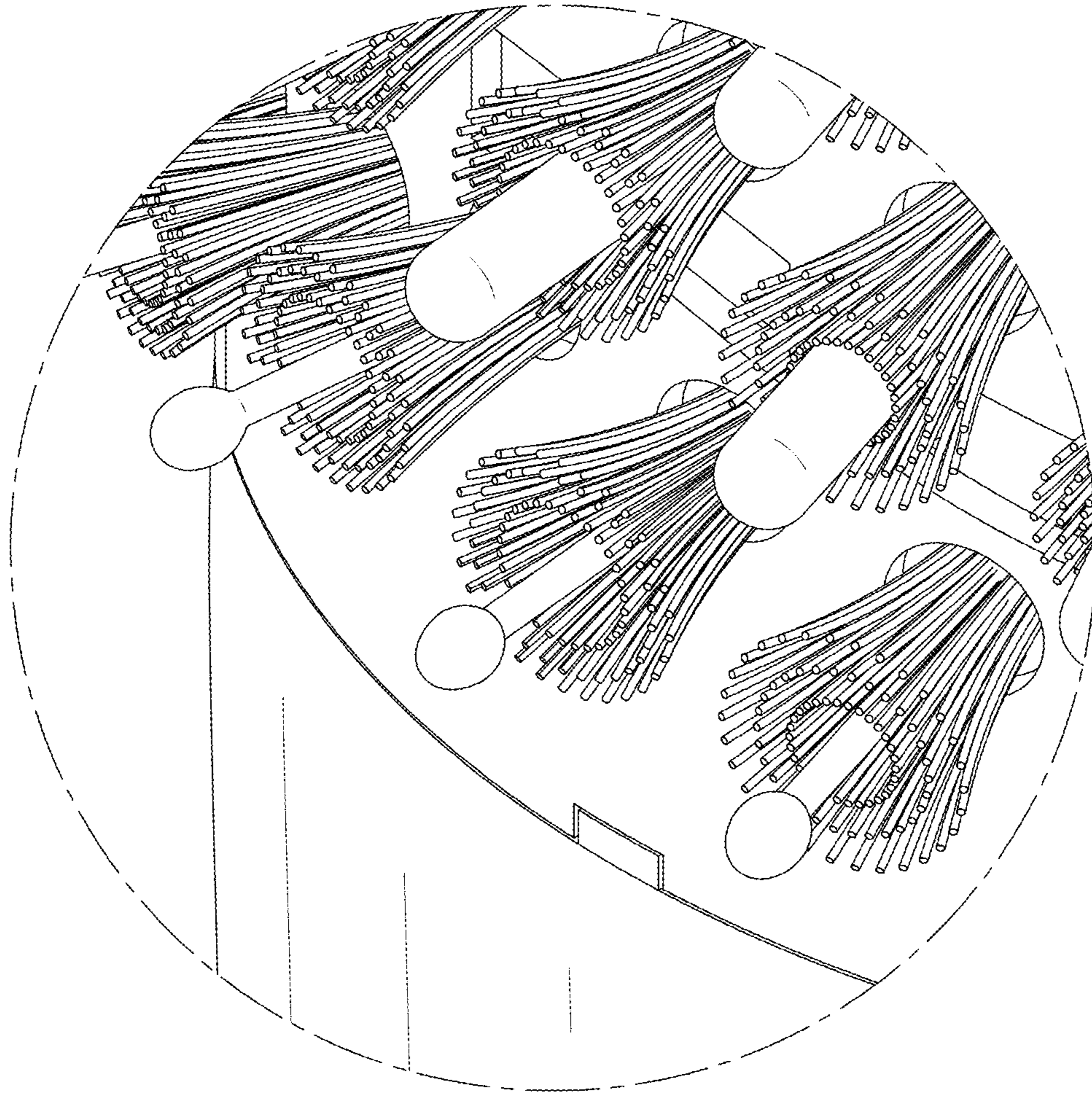

FIG. 9

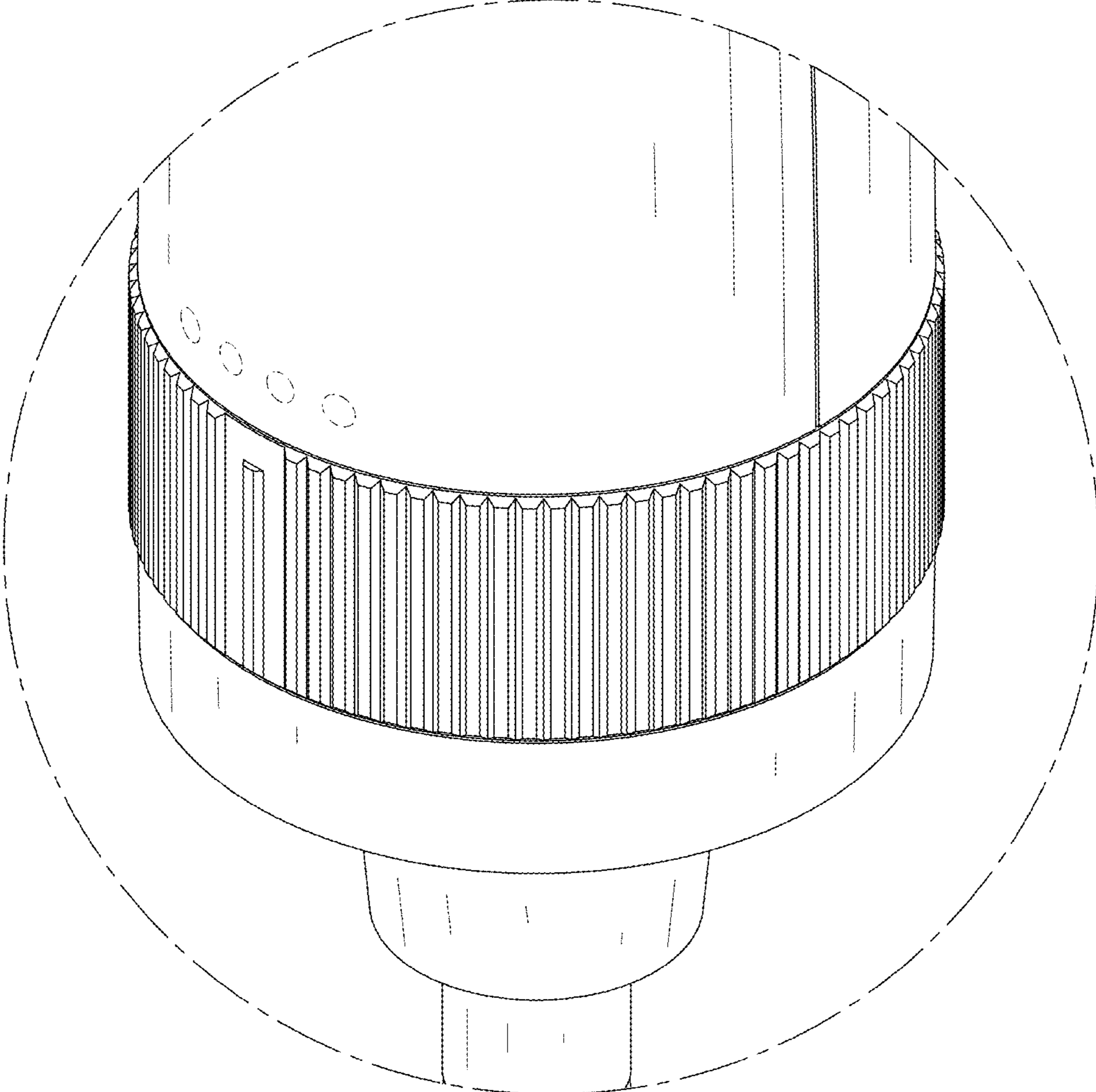

FIG. 10