



US00D879353S

(12) **United States Design Patent**
Lin

(10) **Patent No.:** **US D879,353 S**

(45) **Date of Patent:** **** Mar. 24, 2020**

- (54) **LIGHT**
- (71) Applicant: **SHENZHEN DENGHUI LIGHTING CO., LTD**, Zhongshan (CN)
- (72) Inventor: **Meilan Lin**, Zhanjiang (CN)
- (73) Assignee: **SHENZHEN DENGHUI LIGHTING CO., LTD**, Zhongshan (CN)
- (**) Term: **15 Years**
- (21) Appl. No.: **29/711,602**
- (22) Filed: **Nov. 1, 2019**
- (51) **LOC (12) Cl.** **26-03**
- (52) **U.S. Cl.**
USPC **D26/87; D26/86**
- (58) **Field of Classification Search**
USPC **D26/72, 80, 85, 86, 87, 92, 155**
CPC .. **F21S 8/033; F21S 8/035; F21S 8/036; F21S 8/046**

See application file for complete search history.

D829,957 S *	10/2018	Sonneman	D26/87
D835,324 S *	12/2018	Haubach	D26/86
D836,820 S *	12/2018	Sonneman	D26/86
D869,730 S *	12/2019	Lin	D26/80

OTHER PUBLICATIONS

Solfart Modern 3 Lights Warm Light 3000K LED Vanity Lights for Bathroom Wall Light Fixture—sold at amazon.com Nov. 24, 2019. (Year: 2019).*

Aipsun Modern LED Vanity Light 3 Lights Sold at amazon.com Dec. 6, 2019. (Year: 2019).*

Solfart 4 Lights Modern Glass Stainless Steel Vanity Wall Light sold at amazon.com Jul. 27, 2018. (Year: 2018).*

Mirrea Modern LED Vanity Light in 4 Lights, sold at amazon.com Mar. 12, 2015. (Year: 2015).*

* cited by examiner

Primary Examiner — Clare E Heflin

(57) **CLAIM**

The ornamental design for a light, as shown and described.

DESCRIPTION

FIG. 1 is a perspective view of a light showing my new design;

FIG. 2 is another perspective view thereof;

FIG. 3 is a front elevational view thereof;

FIG. 4 is a rear elevational view thereof;

FIG. 5 is a left side elevational view thereof;

FIG. 6 is a right side elevational view thereof;

FIG. 7 is a top plan view thereof;

FIG. 8 is a bottom plan view thereof; and,

FIG. 9 is an enlarged view of portion 9 shown in FIG. 2. The broken lines in the drawings depict portions of the light that form no part of the claimed design.

1 Claim, 9 Drawing Sheets

- (56) **References Cited**
U.S. PATENT DOCUMENTS
- | | | | | |
|--------------|---------|--------------|-------|--------|
| D168,260 S * | 11/1952 | Gregg | | D26/86 |
| D501,060 S * | 1/2005 | Lee | | D26/80 |
| D589,193 S | 3/2009 | Sabernig | | |
| D608,488 S * | 1/2010 | Miranda | | D26/86 |
| D638,566 S | 5/2011 | Goelz et al. | | |
| D646,424 S * | 10/2011 | Ho | | D26/85 |
| D765,300 S * | 8/2016 | Couture | | D26/85 |
| D770,664 S | 11/2016 | Orozco | | |
| D813,436 S * | 3/2018 | Verelst | | D26/72 |
| D816,881 S * | 5/2018 | Qiao | | D26/86 |
| D816,882 S * | 5/2018 | Qiao | | D26/86 |

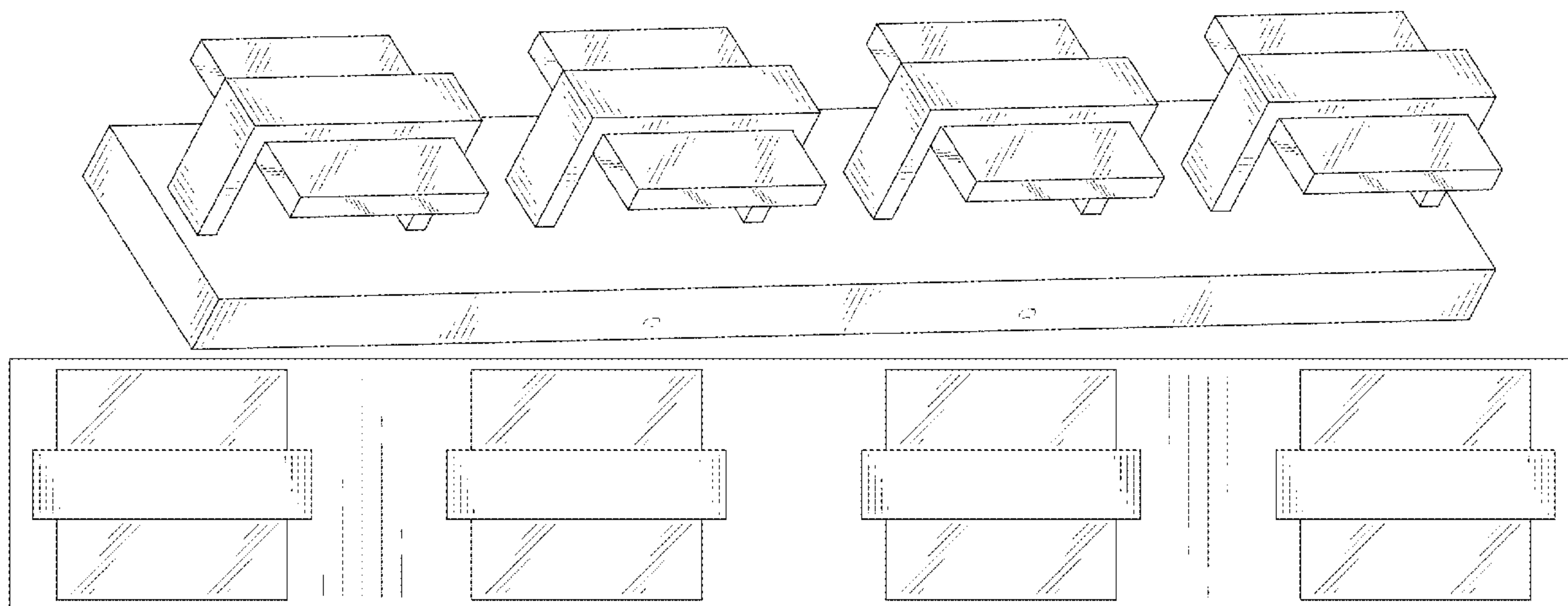

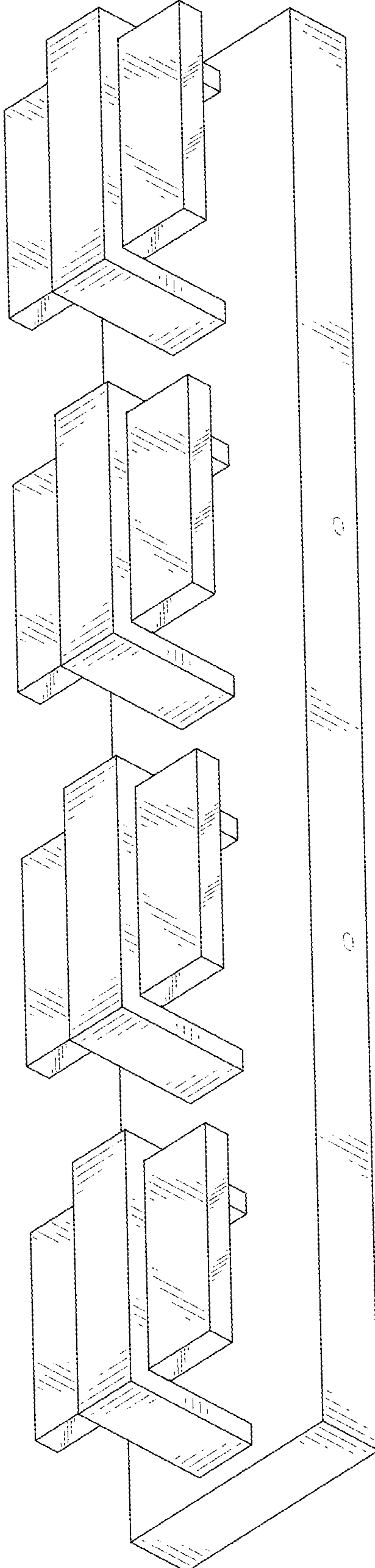

FIG. 1

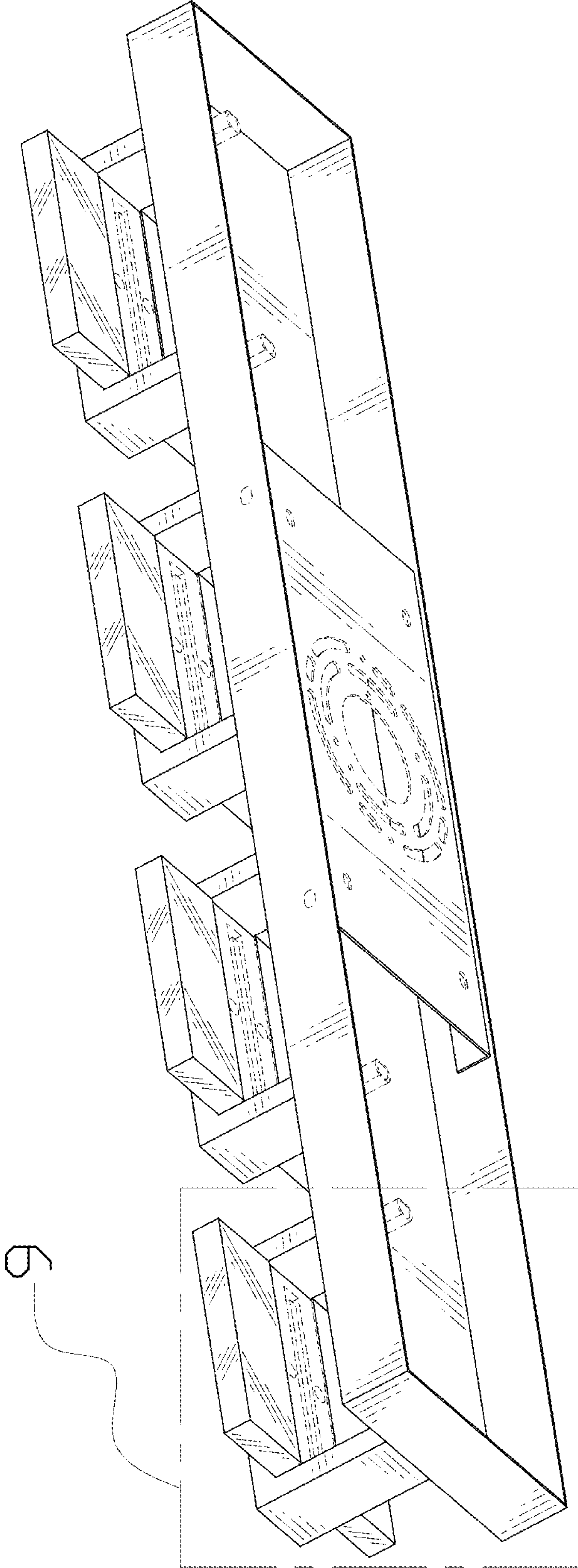

FIG. 2

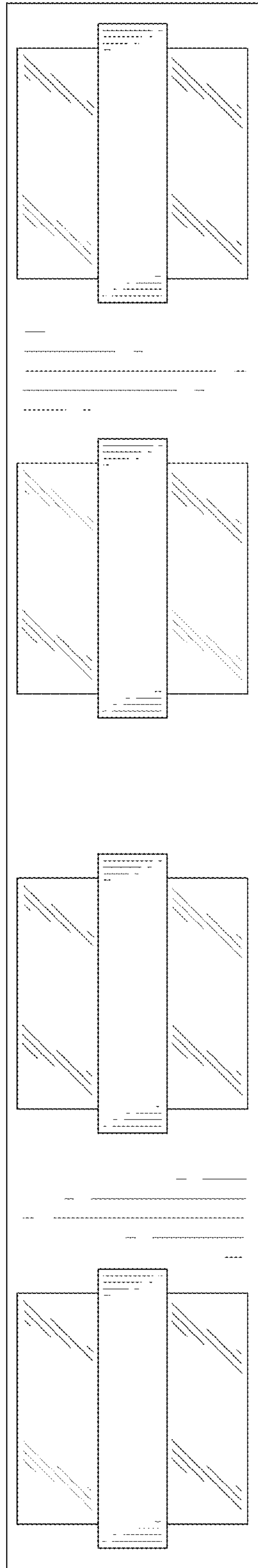

FIG. 3

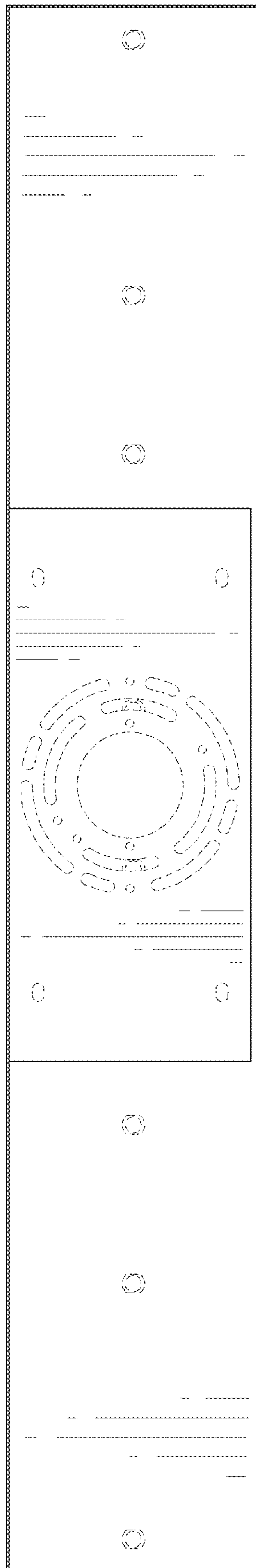

FIG. 4

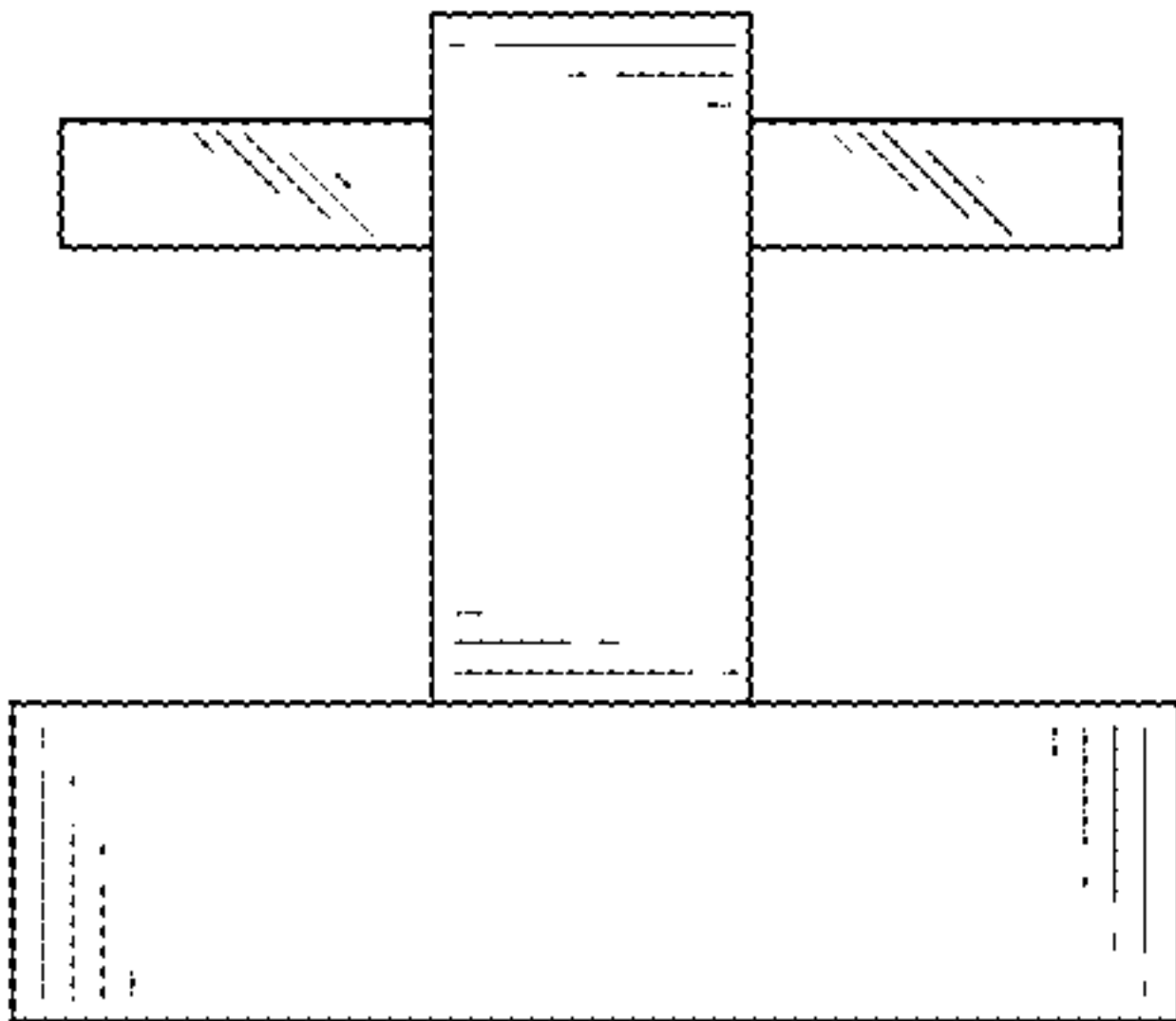

FIG. 5

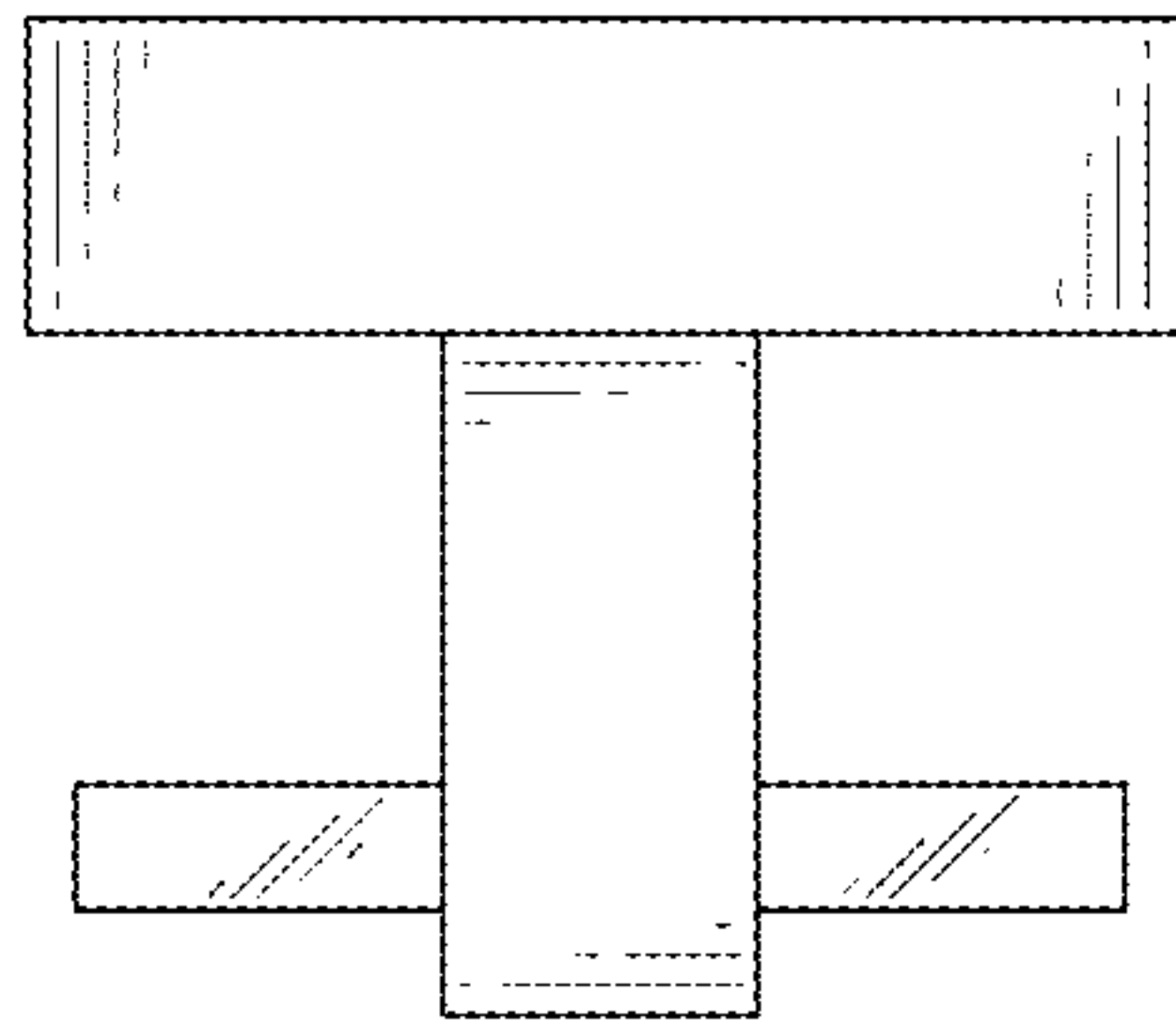

FIG. 6

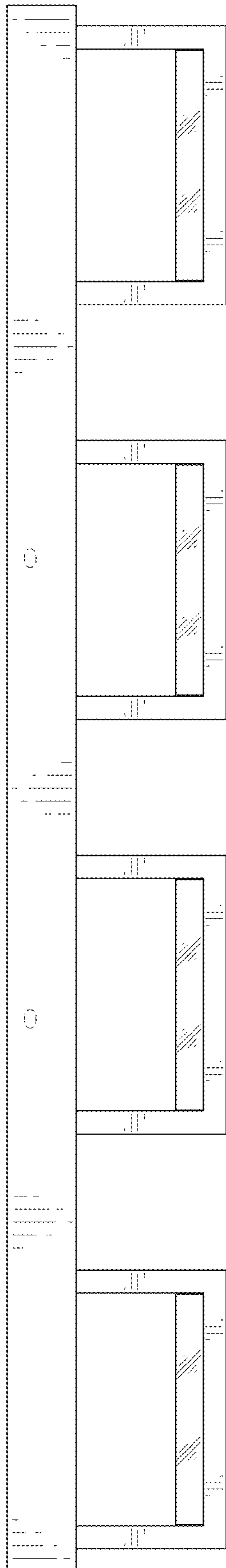

FIG. 7

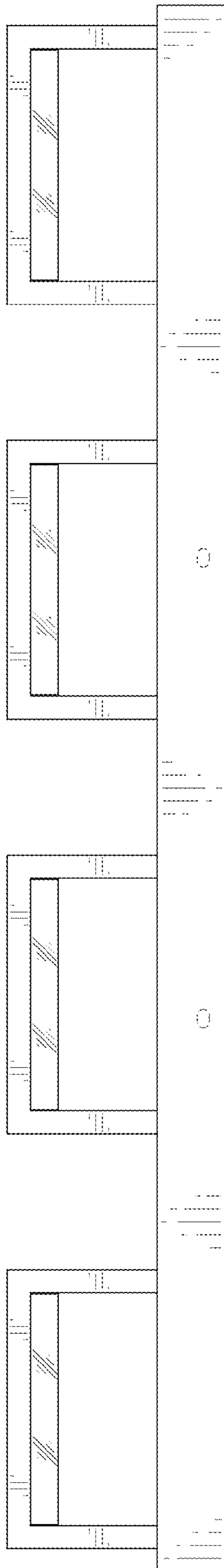

FIG. 8

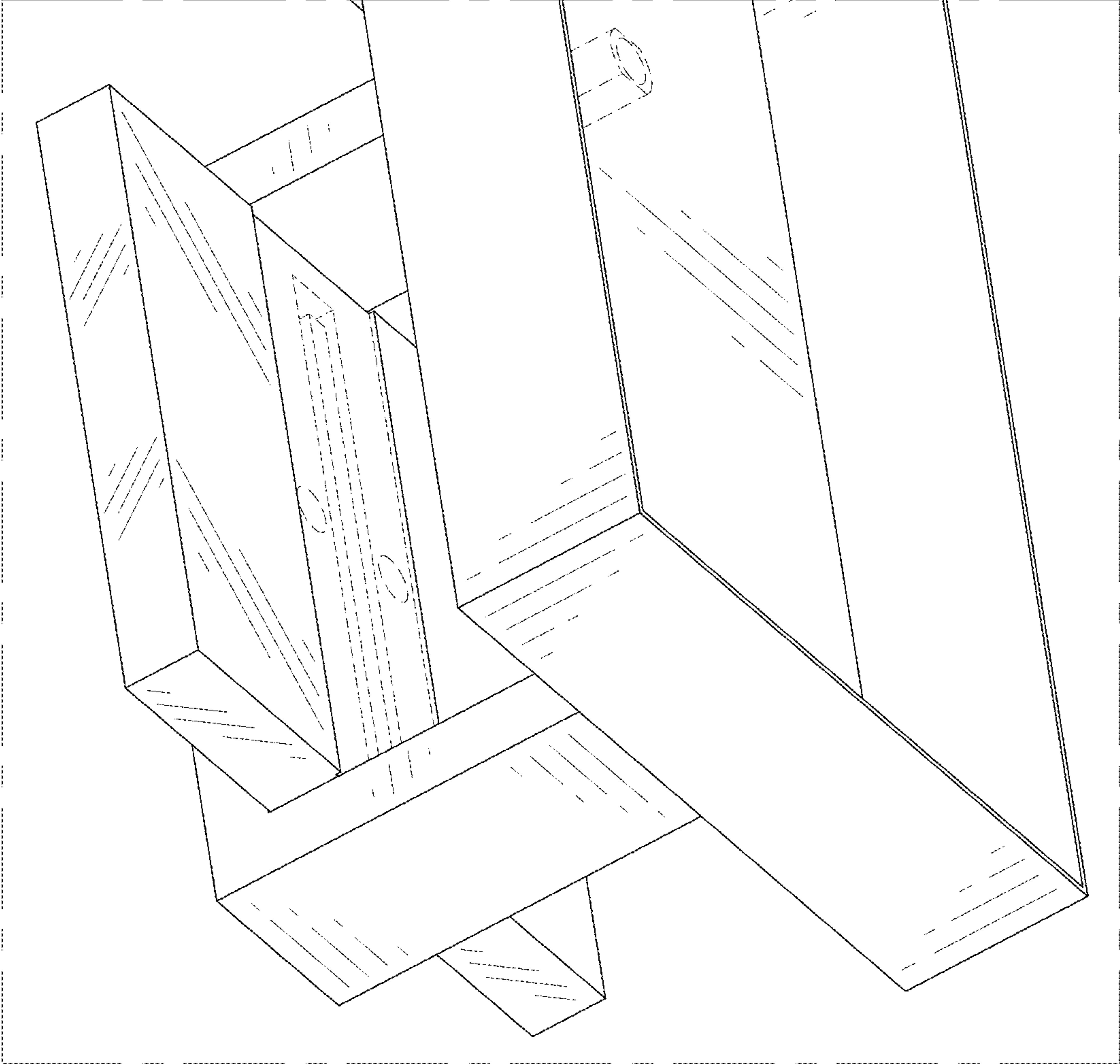

FIG. 9