



US00D879336S

(12) **United States Design Patent**
Eaves

(10) **Patent No.:** **US D879,336 S**

(45) **Date of Patent:** **** Mar. 24, 2020**

(54) **CANDLE COVER**

(71) Applicant: **Andrea G. Eaves**, Queensbury, NY
(US)

(72) Inventor: **Andrea G. Eaves**, Queensbury, NY
(US)

(**) Term: **15 Years**

(21) Appl. No.: **29/580,197**

(22) Filed: **Oct. 6, 2016**

(51) **LOC (12) Cl.** **26-01**

(52) **U.S. Cl.**
USPC **D26/9**

(58) **Field of Classification Search**
USPC D26/6-26; D7/305, 523, 507, 598,
D7/619.1; D9/516, 499, 444
CPC B29C 66/83411; B65D 81/3876; B65D
83/0463; B65D 1/0207; A47G 23/0216;
A47G 23/0241

See application file for complete search history.

(56) **References Cited**

U.S. PATENT DOCUMENTS

D269,638 S *	7/1983	Frye, Jr.	D26/9
4,667,278 A *	5/1987	Poyer	F21S 8/00 362/267
D410,757 S *	6/1999	Clark	D26/23
D451,183 S *	11/2001	Hirano	D23/366
D522,671 S *	6/2006	Niemeyer	D26/20
D542,437 S *	5/2007	Snow	D26/22
D543,647 S *	5/2007	Goldenberg	D26/11
D575,444 S *	8/2008	Lissoni	D26/137
D631,580 S *	1/2011	Franklin	D26/22

D631,581 S *	1/2011	Franklin	D26/22
D634,038 S *	3/2011	Ritzenhoff	D26/22
D658,792 S *	5/2012	Baraky	D26/22
D660,996 S *	5/2012	Rein	D26/22
D678,560 S *	3/2013	Laurenceau	D26/22
D682,448 S *	5/2013	Nugent	D26/22
D767,810 S *	9/2016	Li	D26/96
D788,953 S *	6/2017	Khan	D26/22
D790,749 S *	6/2017	Li	D26/96
D791,391 S *	7/2017	Li	D26/96
D791,392 S *	7/2017	Li	D26/96
D801,574 S *	10/2017	Amato	D26/118
D817,525 S *	5/2018	Miller	D26/22

* cited by examiner

Primary Examiner — Shannon W Morgan

Assistant Examiner — Keith Frank

(57) **CLAIM**

I claim the ornamental design for a candle cover, as shown and described.

DESCRIPTION

FIG. 1 is a perspective view of a candle cover illustrating my new design;

FIG. 2 is a right side view thereof;

FIG. 3 is a left side view thereof;

FIG. 4 is a top view thereof;

FIG. 5 is a bottom view thereof; and,

FIG. 6 is a top perspective view thereof.

The broken lines in FIG. 5 represent portions of the candle cover that forms no part of the claimed design.

The broken lines in FIG. 6 are directed to an environment and forms no part of the claimed design.

1 Claim, 6 Drawing Sheets

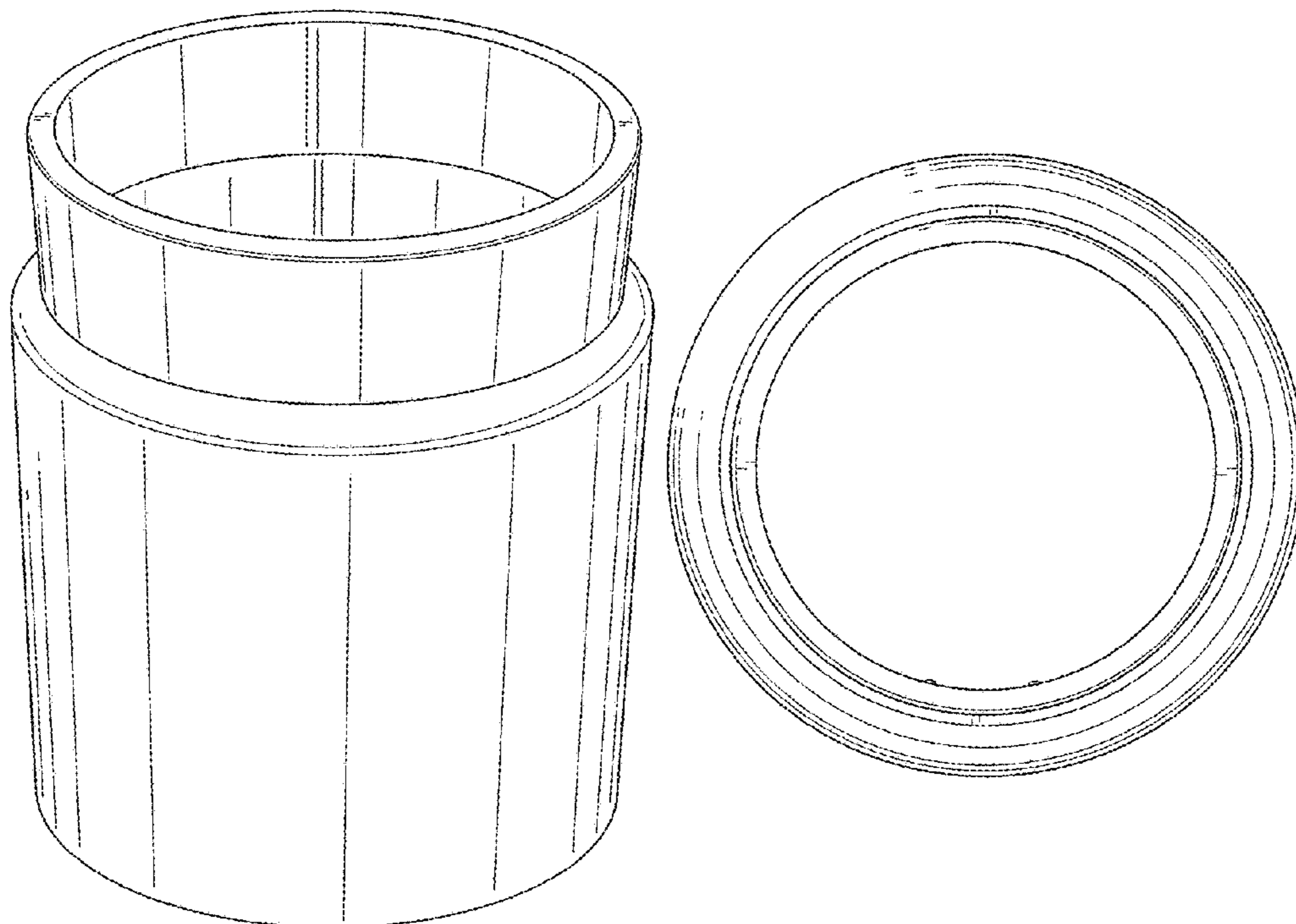

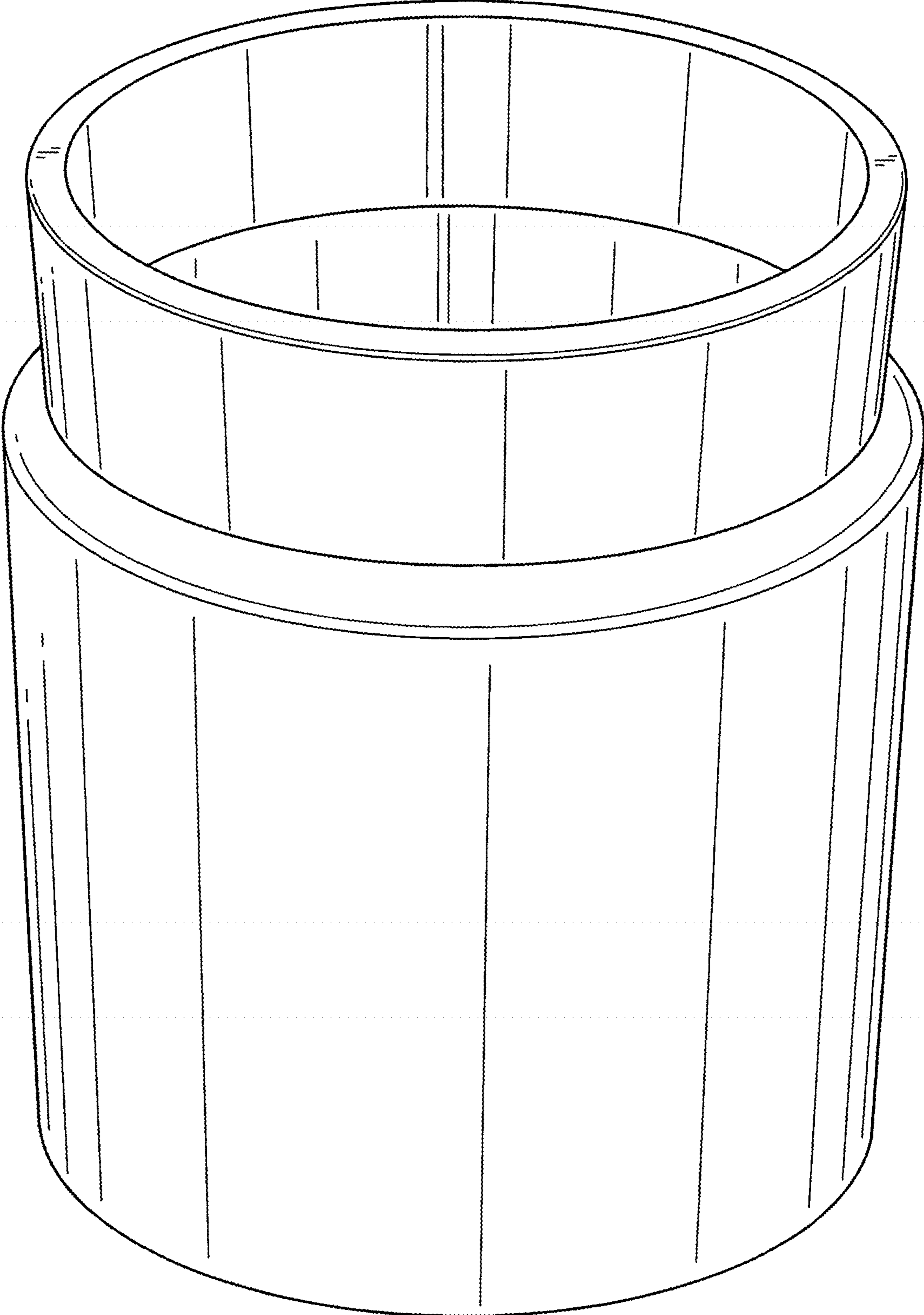

FIG. 1

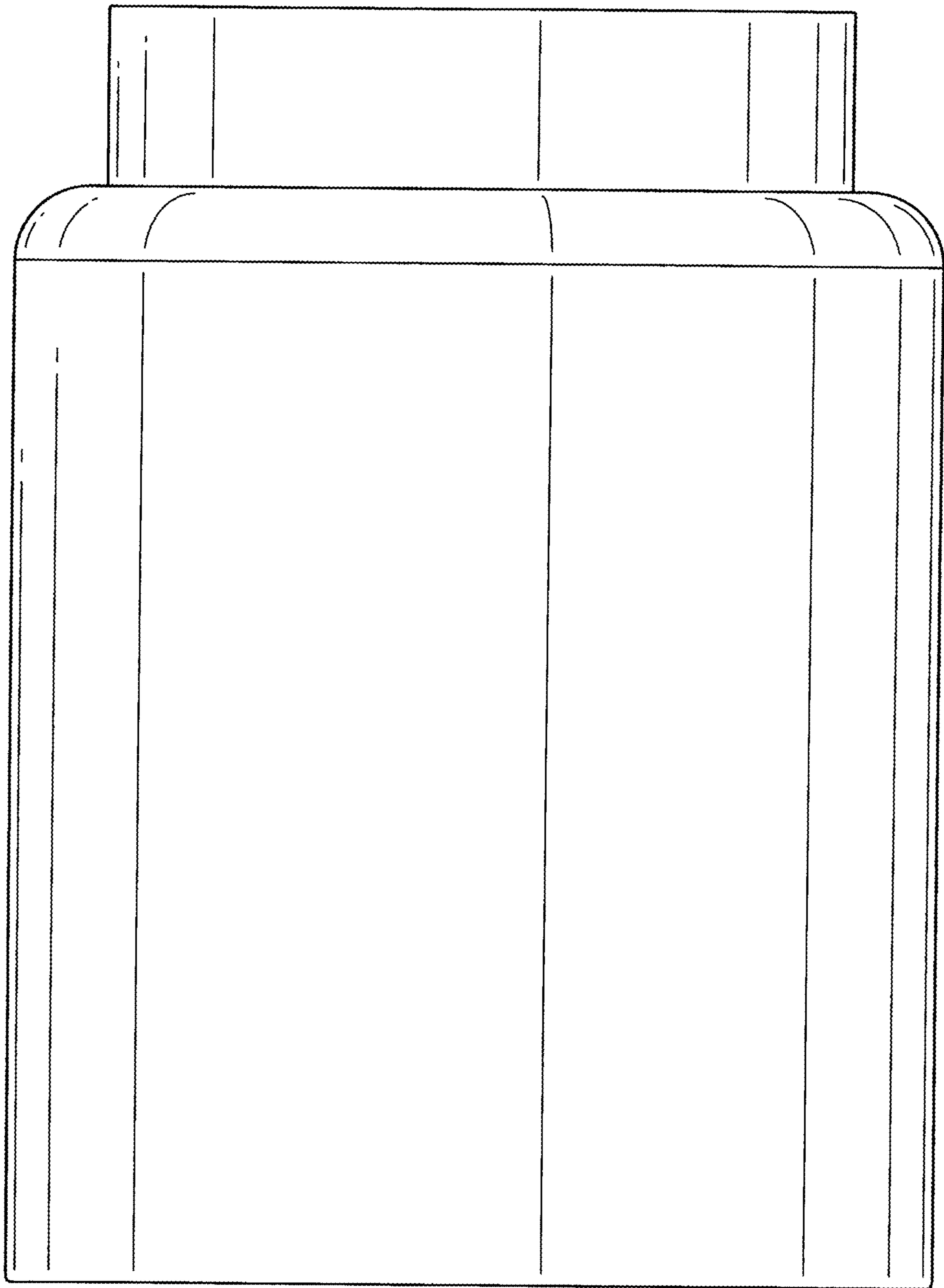

FIG. 2

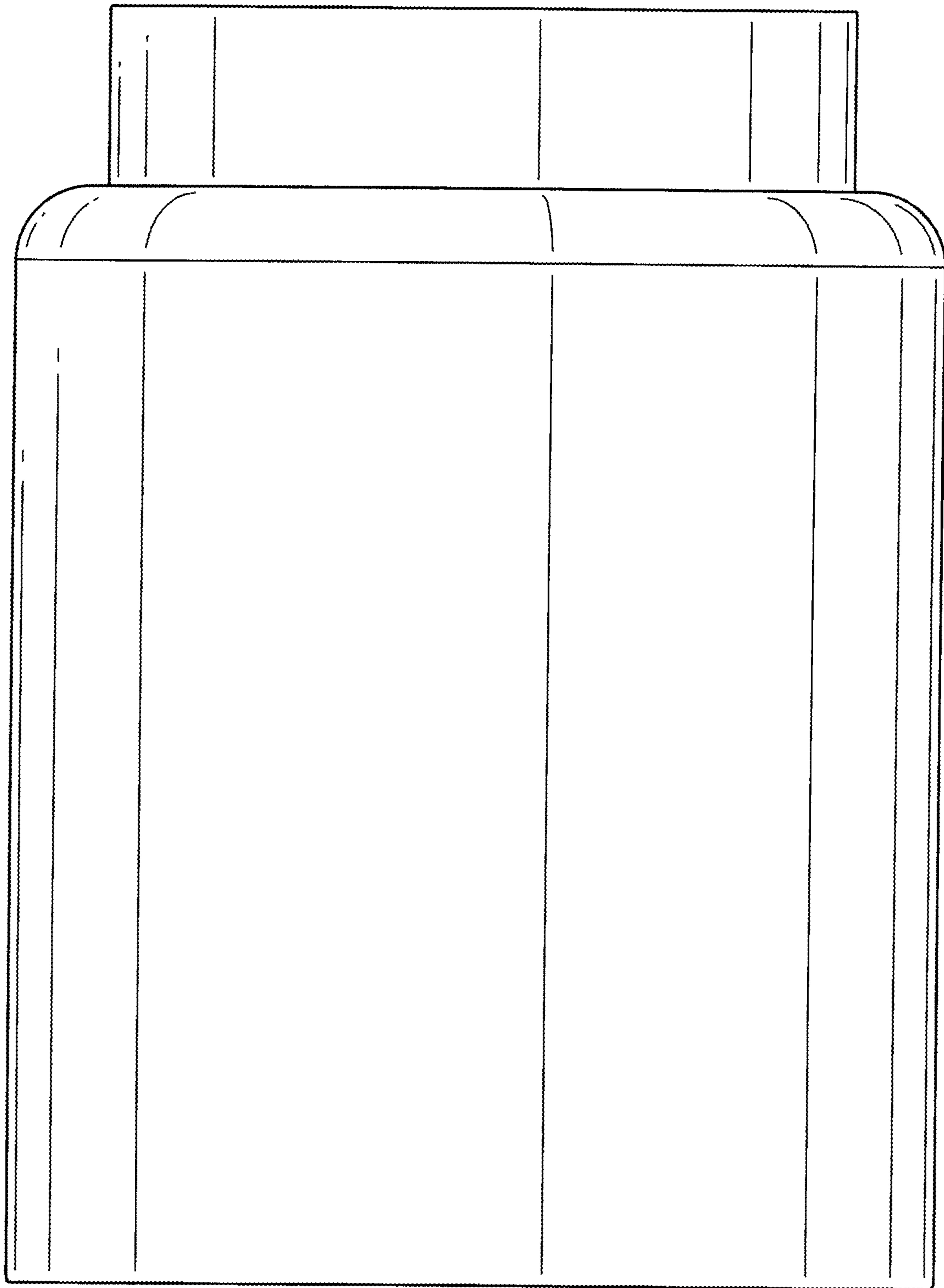

FIG. 3

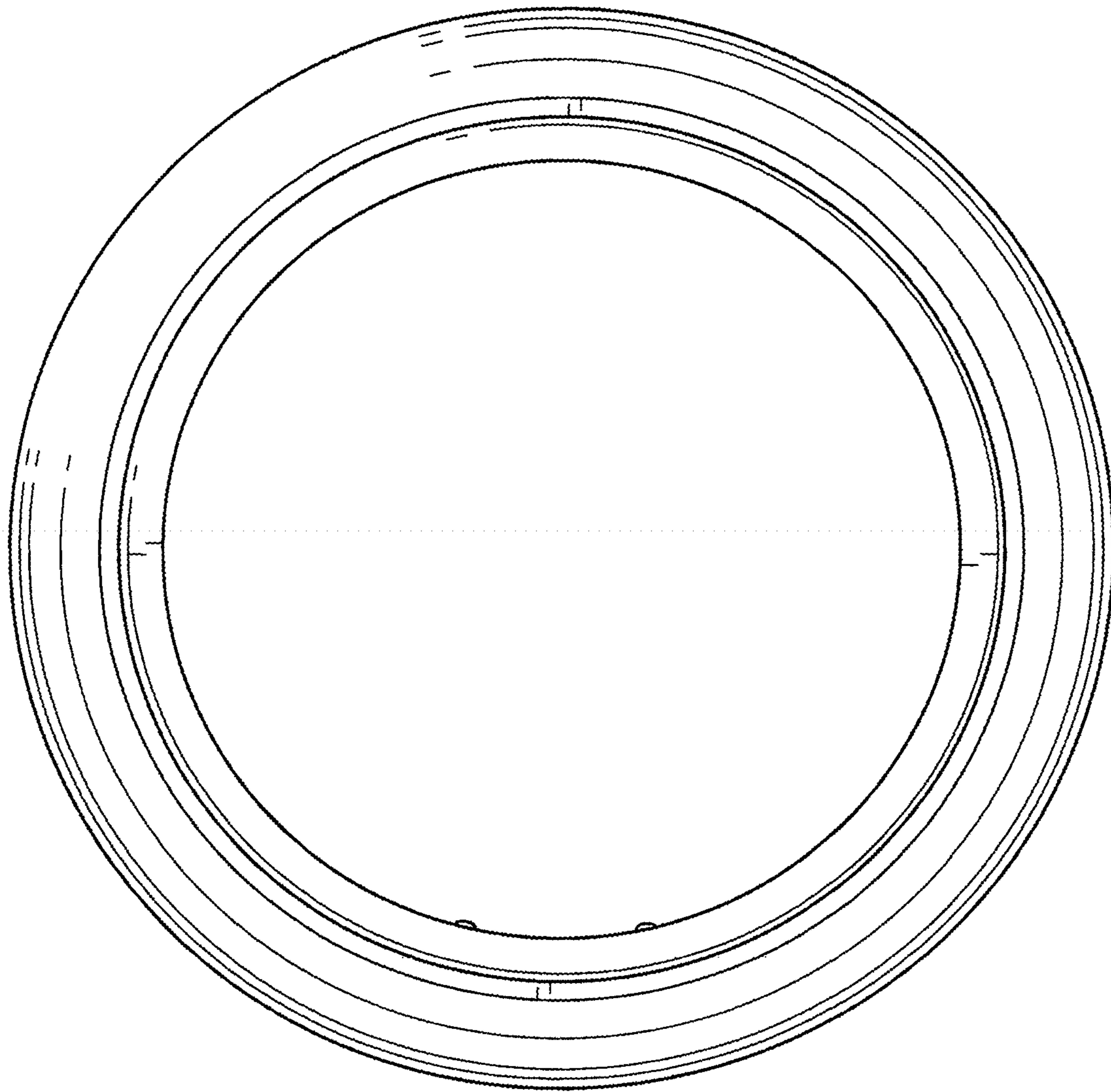

FIG 4

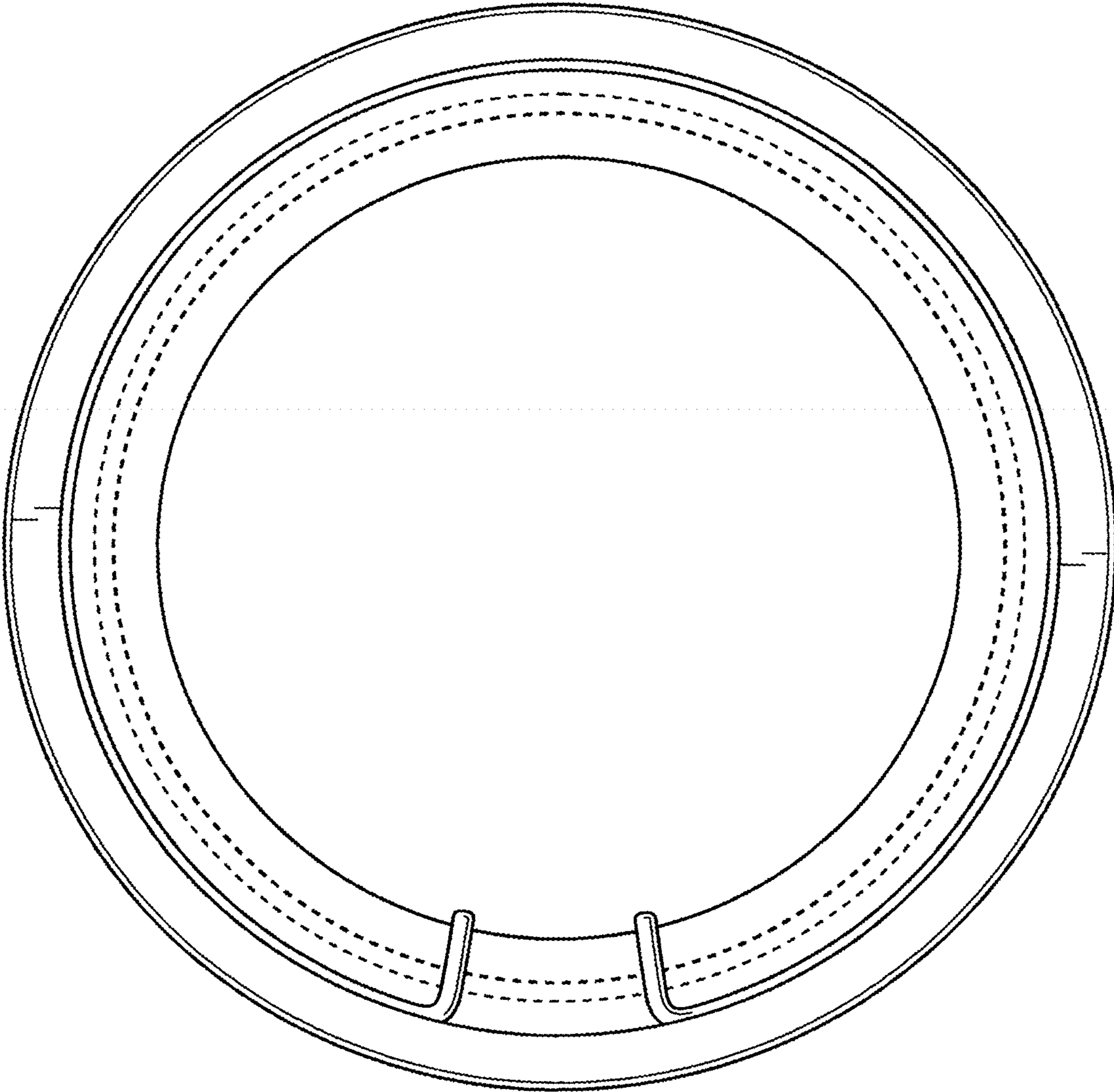

FIG 5

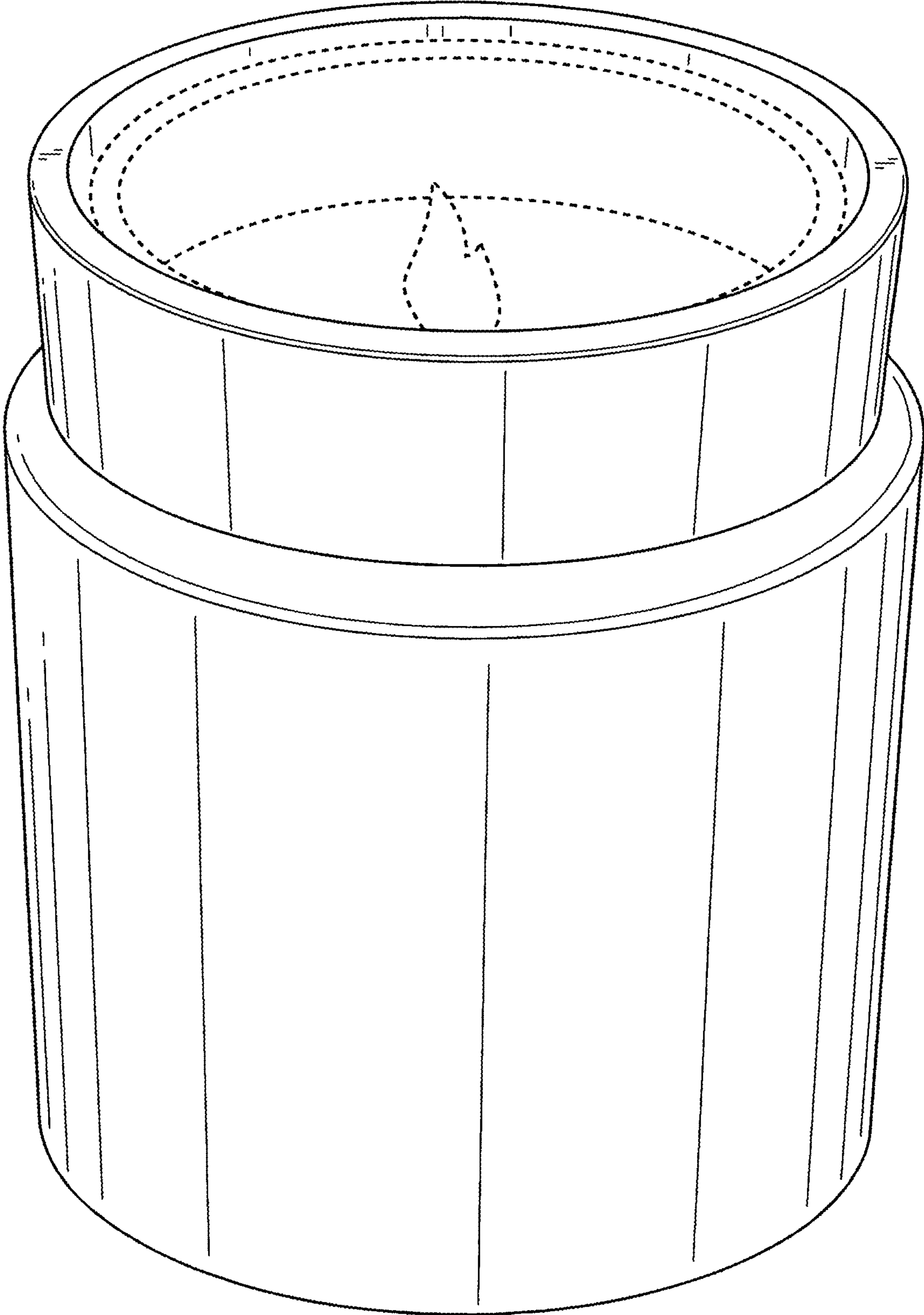

FIG 6