



US00D879267S

(12) **United States Design Patent** (10) **Patent No.:** **US D879,267 S**
Terrill et al. (45) **Date of Patent:** **** Mar. 24, 2020**

(54) **COUNTERTOP**

D681,982 S * 5/2013 Clegg D6/707.19
D759,795 S * 6/2016 LeTourneau D23/284

(71) Applicant: **DENTAL COMPONENTS LLC**,
Newberg, OR (US)

* cited by examiner

(72) Inventors: **David A. Terrill**, Newberg, OR (US);
Austin E. Unsworth, Fort Mill, SC
(US)

Primary Examiner — Sheryl Lane

Assistant Examiner — Samantha N Wood

(74) *Attorney, Agent, or Firm* — Alston & Bird LLP

(73) Assignee: **DENTAL COMPONENTS LLC**,
Newberg, OR (US)

(57) **CLAIM**

We claim the ornamental design for a countertop, as shown
and described.

(**) Term: **15 Years**

DESCRIPTION

(21) Appl. No.: **29/636,653**

FIG. 1 is a perspective view of a countertop showing a first
embodiment of our new design;

(22) Filed: **Feb. 9, 2018**

FIG. 2 is a top plan view thereof;

(51) **LOC (12) Cl.** **23-02**

FIG. 3 is a bottom plan view thereof;

(52) **U.S. Cl.**

FIG. 4 is a front elevation view thereof;

USPC **D23/308**

FIG. 5 is a rear elevation view thereof;

(58) **Field of Classification Search**

FIG. 6 is a right side elevation view thereof;

USPC D23/308, 303, 270, 284, 285, 286, 287,

FIG. 7 is a left side elevation view thereof; and

D23/288, 289, 290, 291, 292, 293.1;

FIG. 8 is another perspective view thereof shown in the
environment of a cabinet;

D6/702, 707, 707.16, 707.19, 707.22,

FIG. 9 is a perspective view of a countertop showing a
second embodiment of our new design;

D6/707.23, 707.24, 691, 691.3

FIG. 10 is a top plan view thereof;

CPC A47B 5/00; A47B 5/02; A47B 5/04; A47B

FIG. 11 is a bottom plan view thereof;

17/04; A47B 1/00; A47B 77/06; A47B

FIG. 12 is a front elevation view thereof;

77/04; E03C 1/18; E03C 1/181

FIG. 13 is a rear elevation view thereof;

See application file for complete search history.

FIG. 14 is a right side elevation view thereof;

(56) **References Cited**

FIG. 15 is a left side elevation view thereof; and,

U.S. PATENT DOCUMENTS

FIG. 16 is another perspective view thereof shown in the
environment of a cabinet.

D106,299 S * 10/1937 Krick D6/668.2

The broken lines showing portions of the cabinet, faucets,
and soap dispensers are included for the purpose of showing
the environmental structure and form no part of the claimed
design.

D241,395 S * 9/1976 Perl D6/707.18

D333,228 S * 2/1993 Hosoe D6/696.3

D452,626 S * 1/2002 Petri D6/707.22

D468,142 S * 1/2003 Plavsic D6/707.22

D499,469 S * 12/2004 Trepanier D23/286

D650,612 S * 12/2011 Frinier D6/691.3

1 Claim, 10 Drawing Sheets

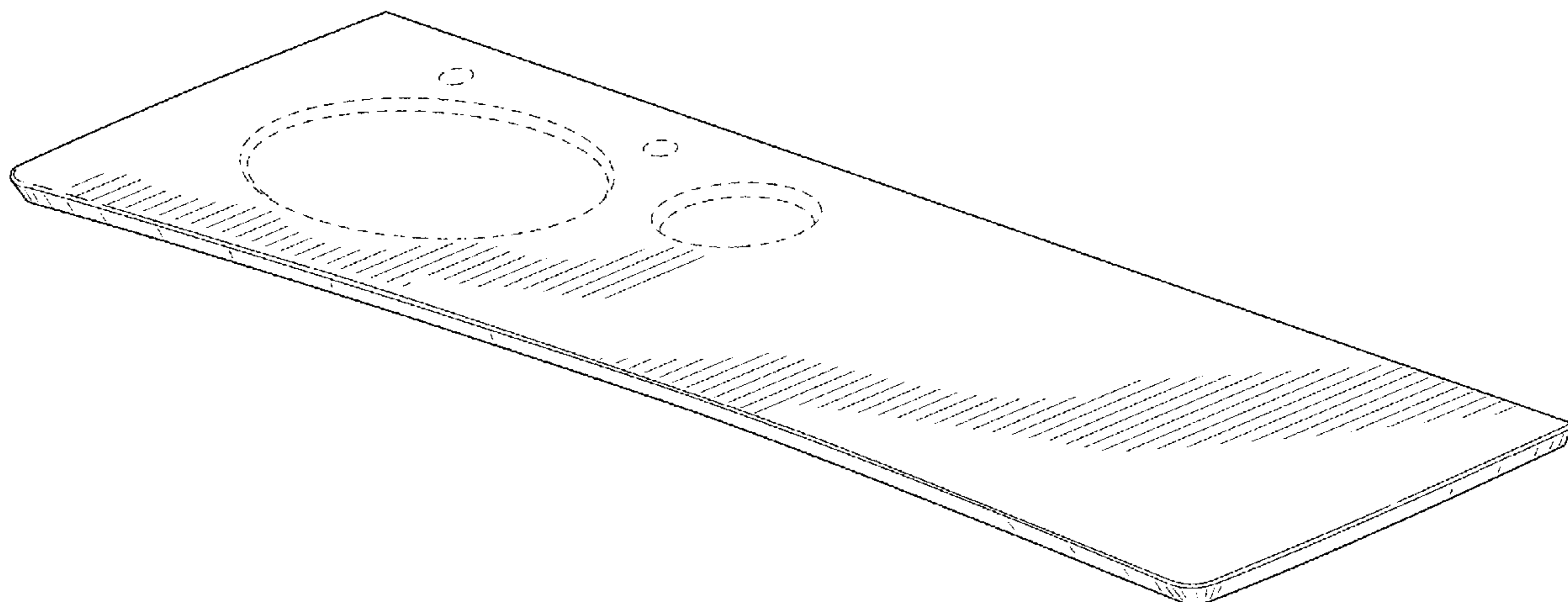

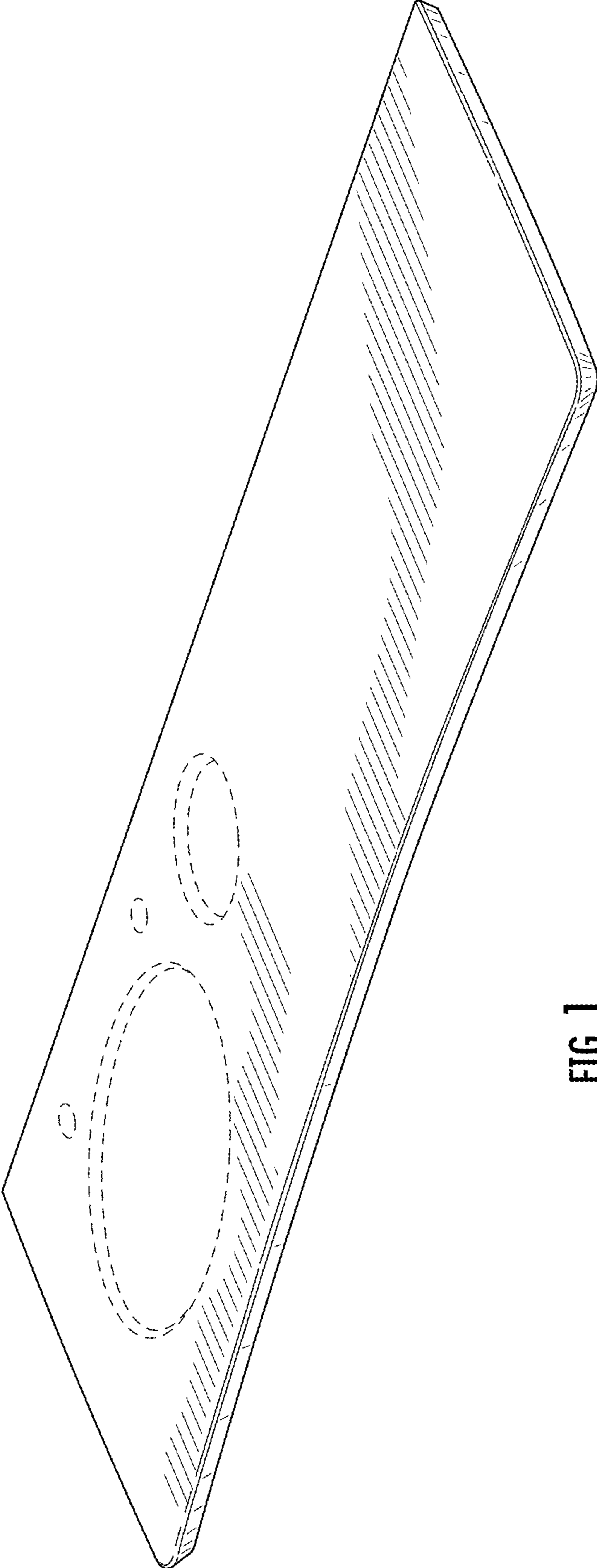

FIG. 1

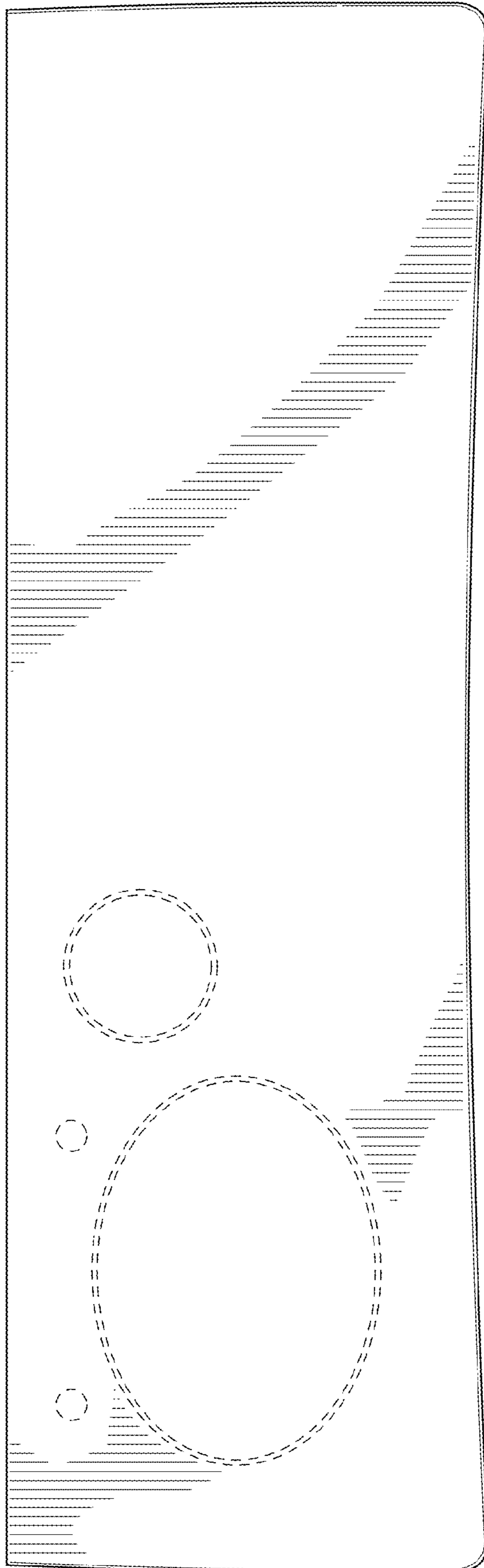

FIG. 2

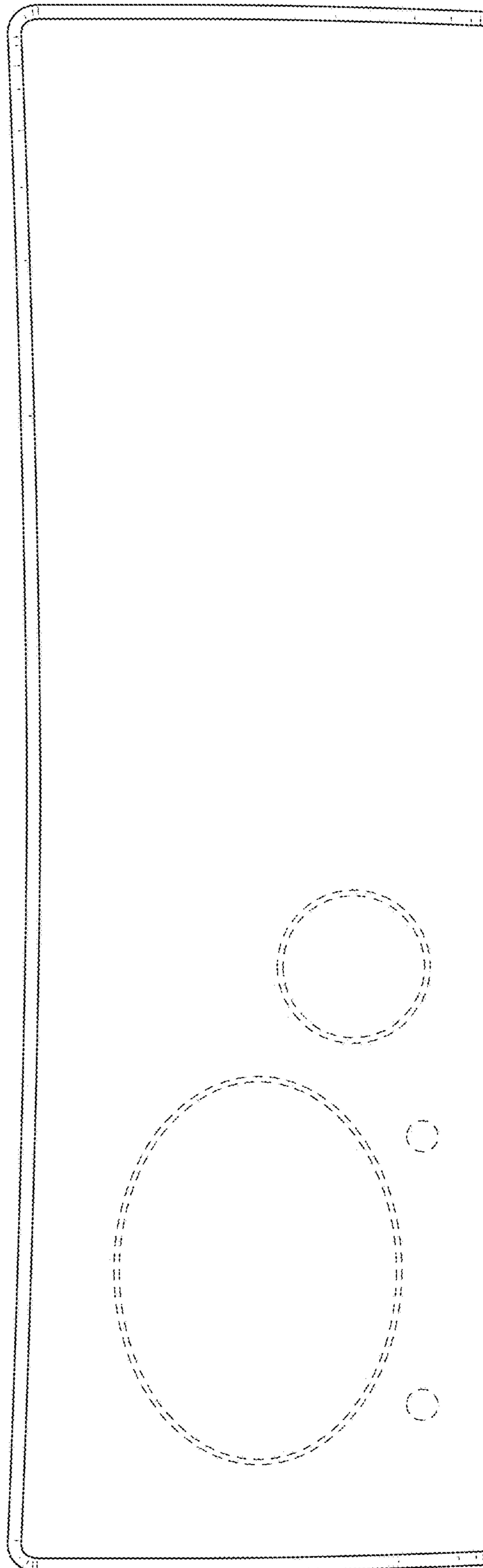

FIG. 3

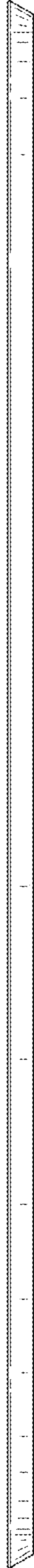

FIG. 4

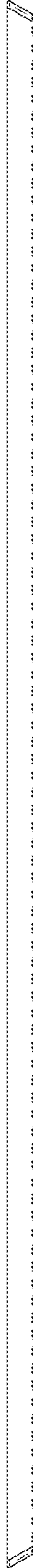

FIG. 5



FIG. 6



FIG. 7

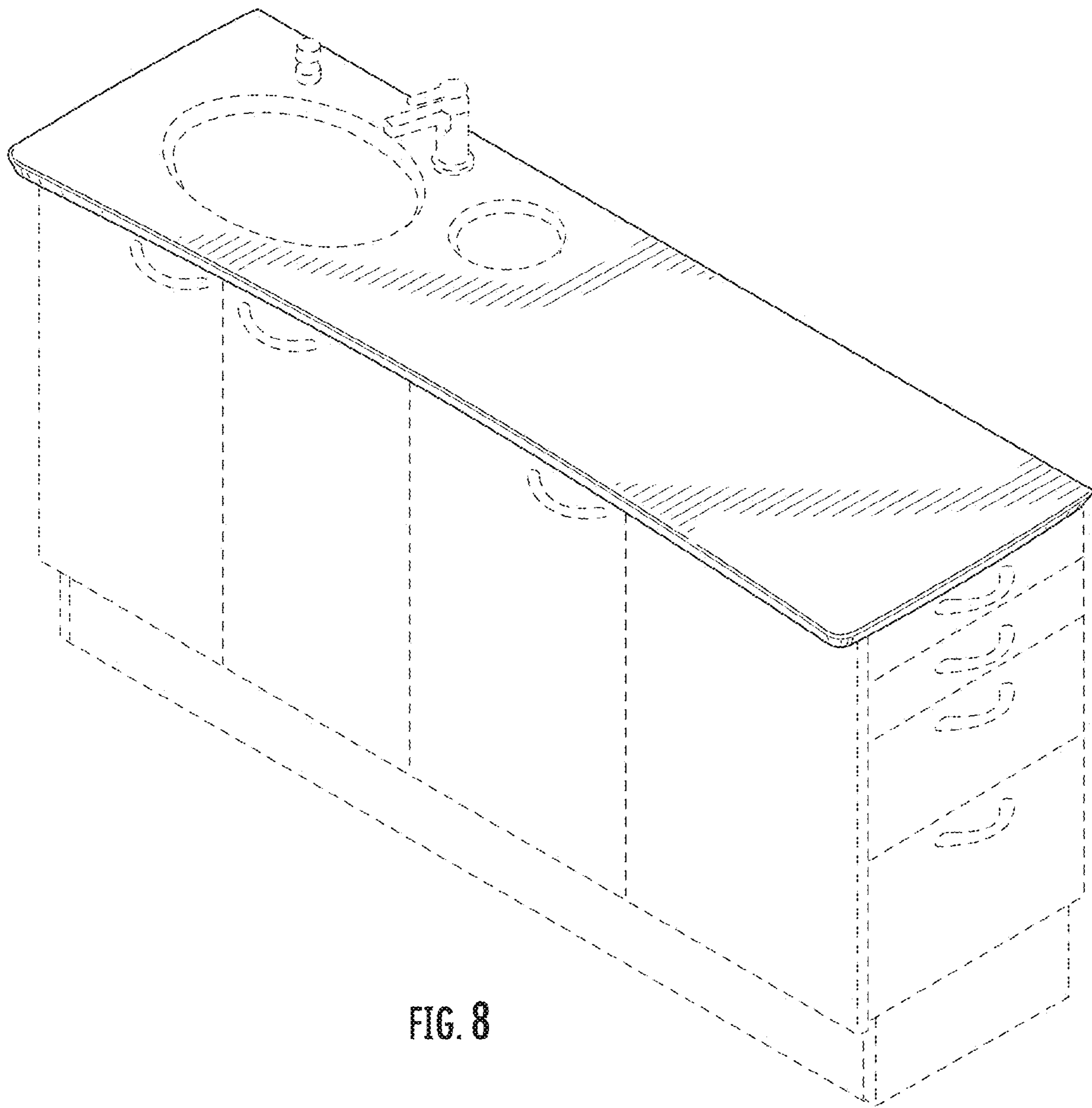

FIG. 8

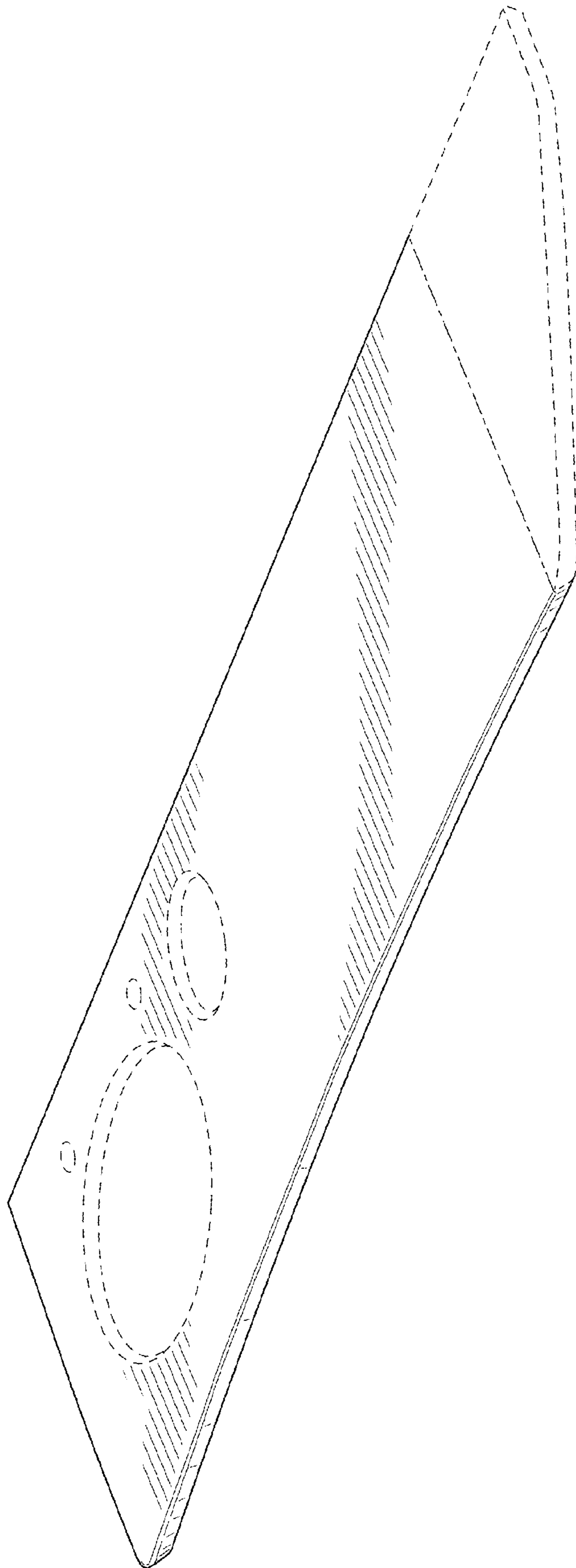

FIG. 9

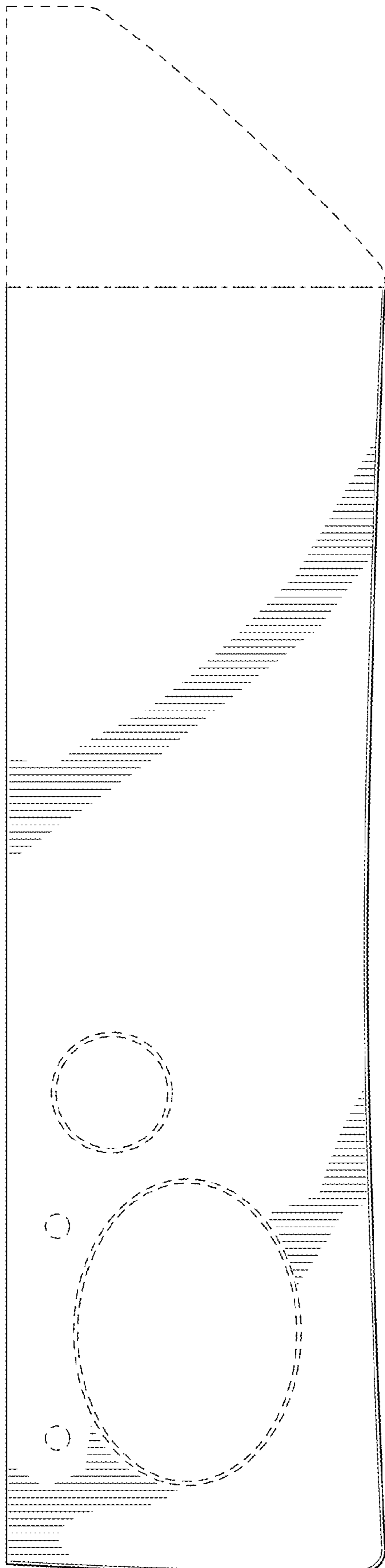

FIG. 10

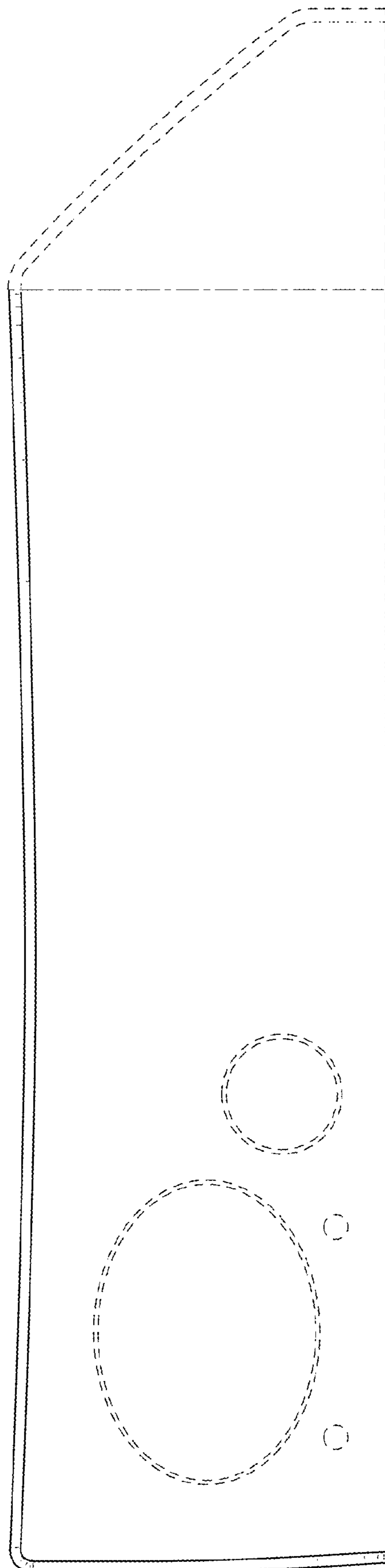

FIG. 11



FIG. 12

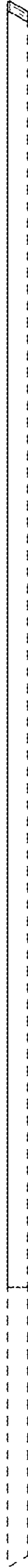

FIG. 13

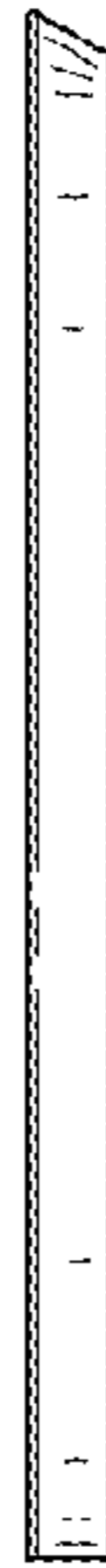

FIG. 14

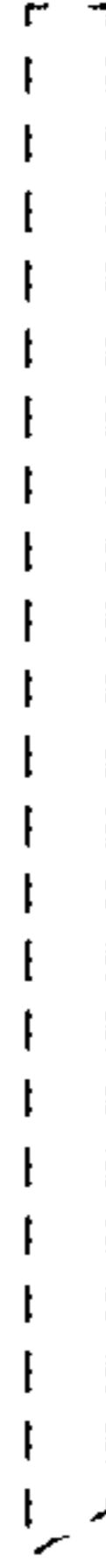

FIG. 15

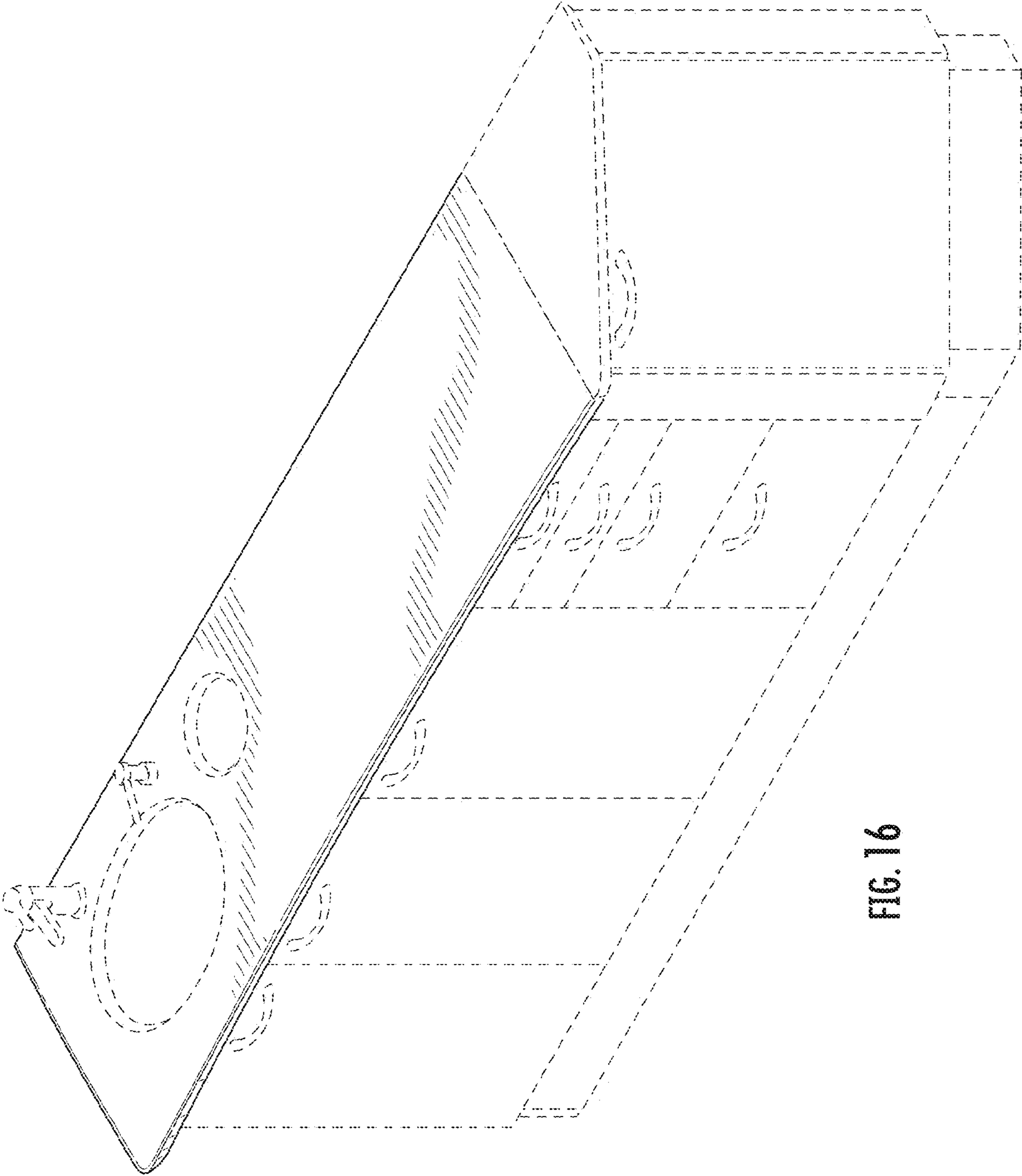

FIG. 16