



US00D879247S

(12) **United States Design Patent**  
**Stoler**

(10) **Patent No.:** **US D879,247 S**

(45) **Date of Patent:** **\*\* Mar. 24, 2020**

- (54) **HAND SHOWER**
- (71) Applicant: **DELTA FAUCET COMPANY**,  
Indianapolis, IN (US)
- (72) Inventor: **Benjamin Stoler**, Carmel, IN (US)
- (73) Assignee: **DELTA FAUCET COMPANY**,  
Indianapolis, IN (US)
- (\*\*) Term: **15 Years**
- (21) Appl. No.: **29/680,604**
- (22) Filed: **Feb. 18, 2019**
- (51) **LOC (12) Cl.** ..... **23-01**
- (52) **U.S. Cl.**  
USPC ..... **D23/223; D23/213**
- (58) **Field of Classification Search**  
USPC ..... D23/213, 214, 215, 223, 224, 226, 229,  
D23/230  
CPC ..... A61H 9/0021; A61H 33/00; B05B 1/00;  
B05B 1/14; B05B 1/185; B05B 1/08;  
B05B 1/02; B05B 1/26; B05B 12/002;  
B05B 1/18; B05B 9/01  
See application file for complete search history.

(56) **References Cited**

**U.S. PATENT DOCUMENTS**

D487,498 S *	3/2004	Blomstrom	.....	D23/213
D508,730 S *	8/2005	Blomstrom	.....	D23/229
D524,412 S *	7/2006	Blomstrom	.....	D23/229
D680,619 S *	4/2013	Zhadanov	.....	D23/223
D681,776 S *	5/2013	Cutler	.....	D23/223
D694,357 S *	11/2013	Brodey	.....	D23/213
D694,359 S *	11/2013	Schoenherr	.....	D23/213
D707,330 S *	6/2014	Schoenherr	.....	D23/223
D713,004 S *	9/2014	Schoenherr	.....	D23/223
D713,496 S *	9/2014	Schoenherr	.....	D23/213
D718,418 S *	11/2014	Georgeson	.....	D23/213
D730,493 S *	5/2015	Sehl	.....	D23/261
D733,258 S *	6/2015	Sandee	.....	D23/223
D737,931 S *	9/2015	Schoenherr	.....	D23/223

D737,932 S *	9/2015	Nikles	.....	D23/223
D743,507 S *	11/2015	Georgeson	.....	D23/252
D746,955 S *	1/2016	Corder	.....	D23/261
D752,711 S *	3/2016	Georgeson	.....	D23/213
9,387,495 B2 *	7/2016	Schumacher	.....	B05B 1/30
D778,404 S *	2/2017	Schoenherr	.....	D23/223
D779,038 S *	2/2017	Hanna	.....	D23/223
D779,039 S *	2/2017	Hanna	.....	D23/223
D801,475 S *	10/2017	Naslund	.....	D23/213
D803,350 S *	11/2017	Tian	.....	D23/213
D808,499 S *	1/2018	Naslund	.....	D23/213
D809,094 S *	1/2018	Naslund	.....	D23/213
D810,233 S *	2/2018	Winter	.....	D23/213
D810,861 S *	2/2018	Weaver	.....	D23/213

(Continued)

**OTHER PUBLICATIONS**

[https://www.amazon.com/Faucet-59552-PN-PK-Shower-Polished-Nickel/dp/B00P41TGPA/ref=sr\\_1\\_466?keywords=delta+hand+shower&qid=1578947607&s=hi&sr=1-466](https://www.amazon.com/Faucet-59552-PN-PK-Shower-Polished-Nickel/dp/B00P41TGPA/ref=sr_1_466?keywords=delta+hand+shower&qid=1578947607&s=hi&sr=1-466) (Year: 2014).\*

*Primary Examiner* — Manpreet S Matharu

*Assistant Examiner* — Keith J Wilson

(74) *Attorney, Agent, or Firm* — Edgar A. Zarins; Nirav D. Parikh

(57) **CLAIM**

The ornamental design for a hand shower, as shown and described.

**DESCRIPTION**

FIG. 1 is a front perspective view of a hand shower showing my new design;  
FIG. 2 is a rear perspective view thereof;  
FIG. 3 is a front elevational view thereof;  
FIG. 4 is a left side view thereof;  
FIG. 5 is a rear view thereof;  
FIG. 6 is a right side view thereof;  
FIG. 7 is a top plan view thereof; and,  
FIG. 8 is a bottom view thereof.

**1 Claim, 4 Drawing Sheets**

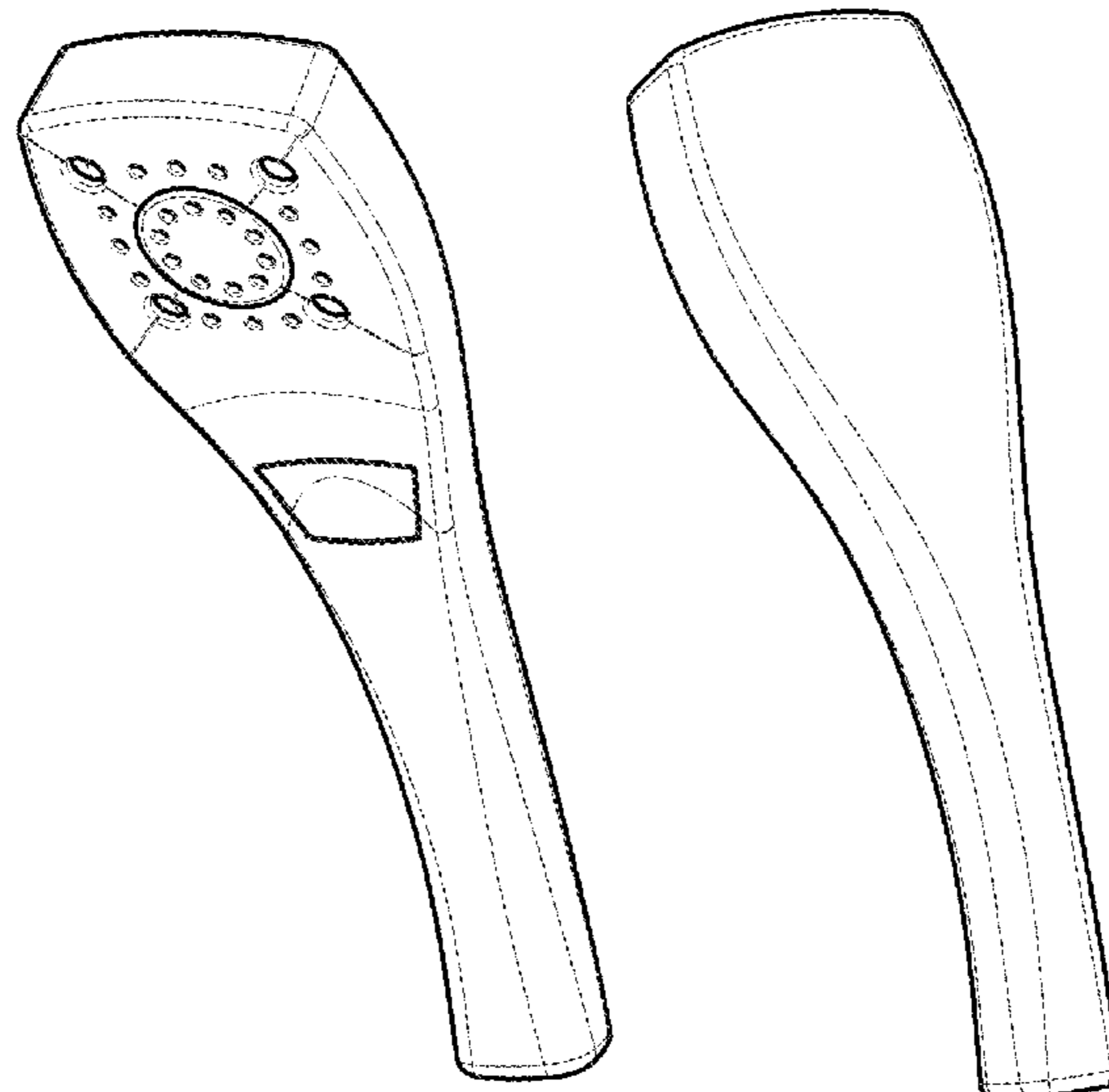

(56)

**References Cited**

U.S. PATENT DOCUMENTS

D811,524 S *	2/2018	Bossini .....	D23/223
D820,388 S *	6/2018	Seum .....	D23/213
D820,949 S *	6/2018	Reinecker .....	D23/213
D821,542 S *	6/2018	Reinecker .....	D23/213
D824,485 S *	7/2018	Montoya .....	D23/213
D833,575 S *	11/2018	Soulier .....	D23/223
D839,384 S *	1/2019	Svendsen .....	D23/213
D840,503 S *	2/2019	Stein .....	D23/213
D841,121 S *	2/2019	Kiefer .....	D23/213
D841,125 S *	2/2019	Lai .....	D23/223
D842,429 S *	3/2019	Huang .....	D23/213
D842,430 S *	3/2019	Huang .....	D23/213
D842,431 S *	3/2019	Cacka .....	D23/213
D842,967 S *	3/2019	Farley .....	D23/213
D858,700 S *	9/2019	Stoler .....	D23/223

\* cited by examiner

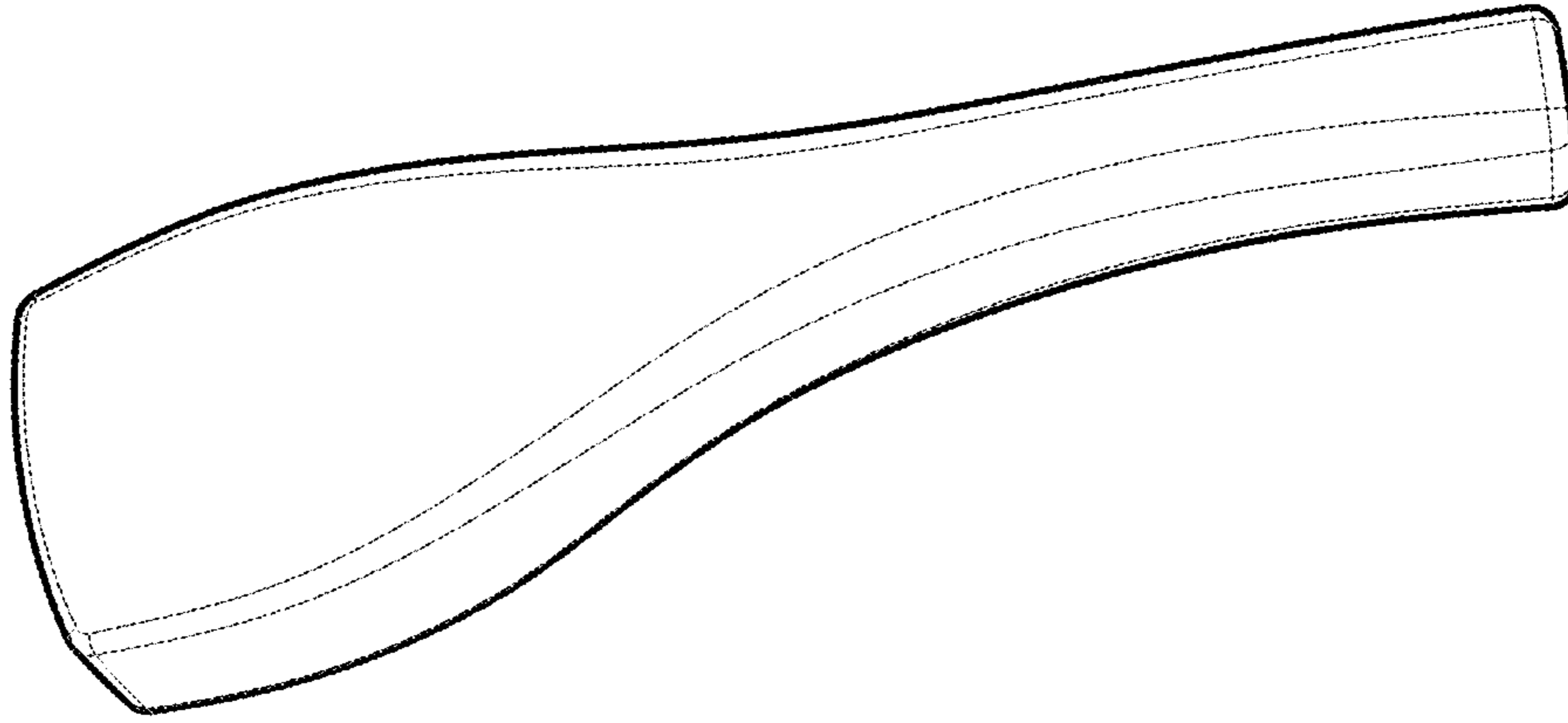

FIG - 2

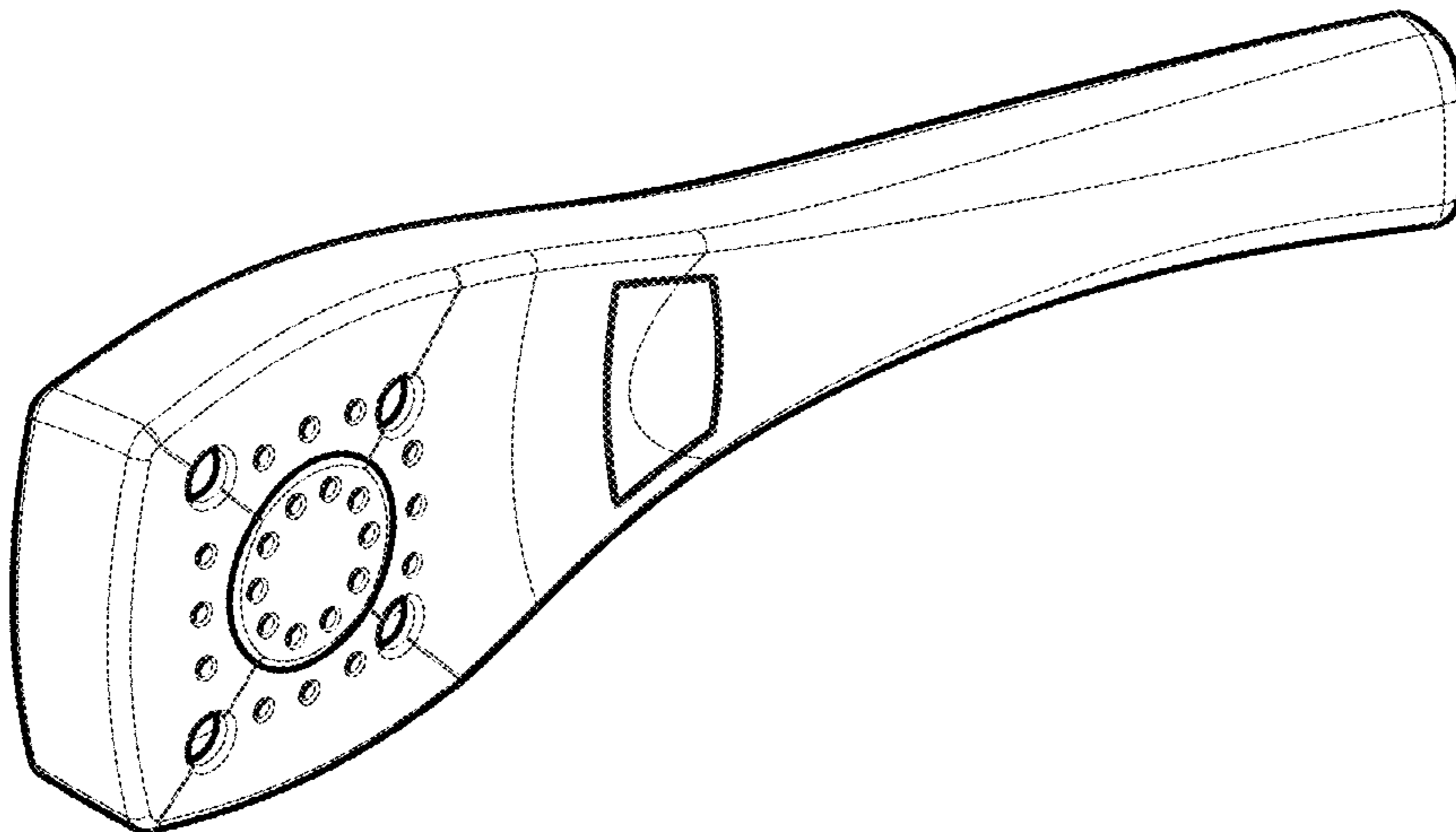

FIG - 1



FIG - 4

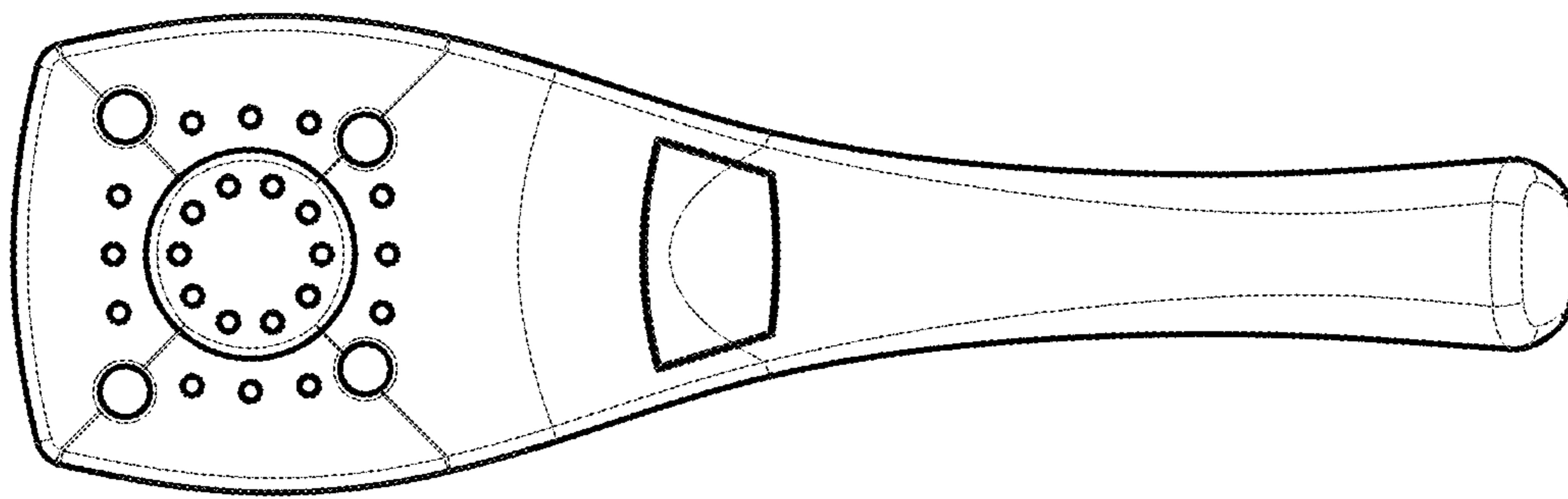

FIG - 3



FIG - 6

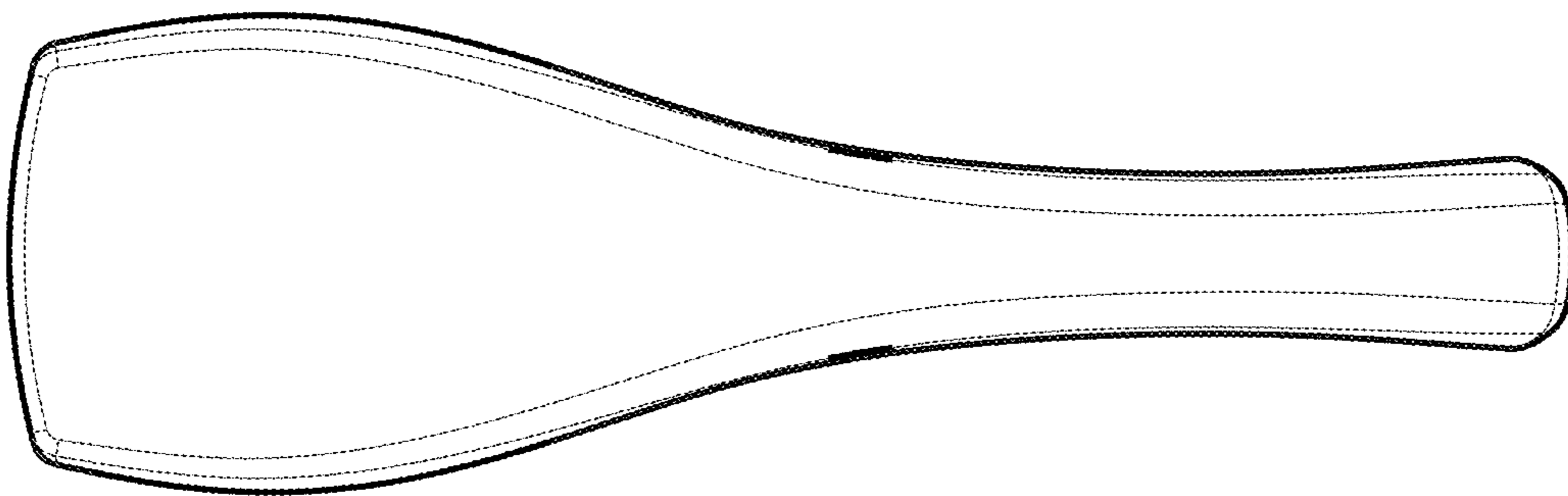

FIG - 5

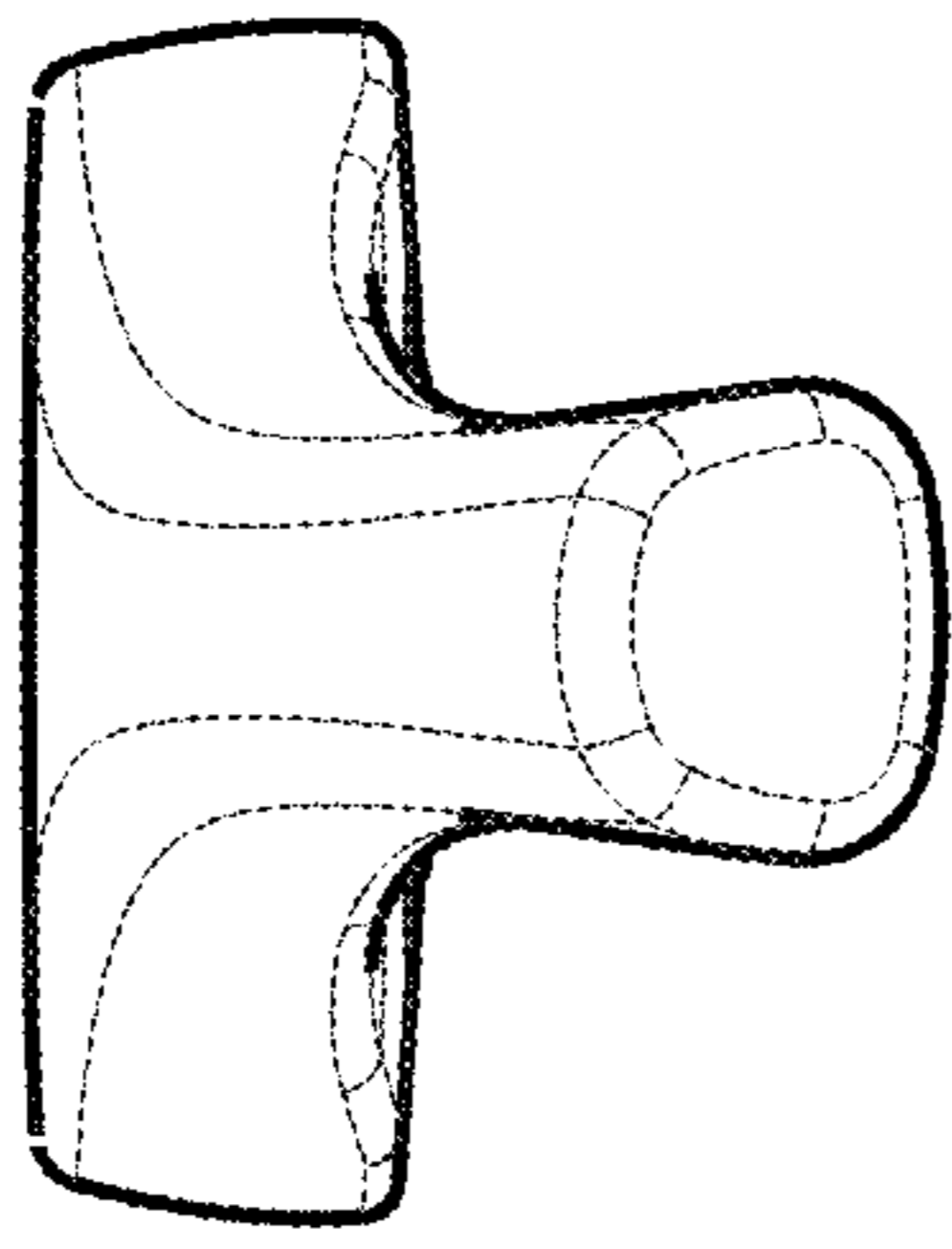

FIG - 8

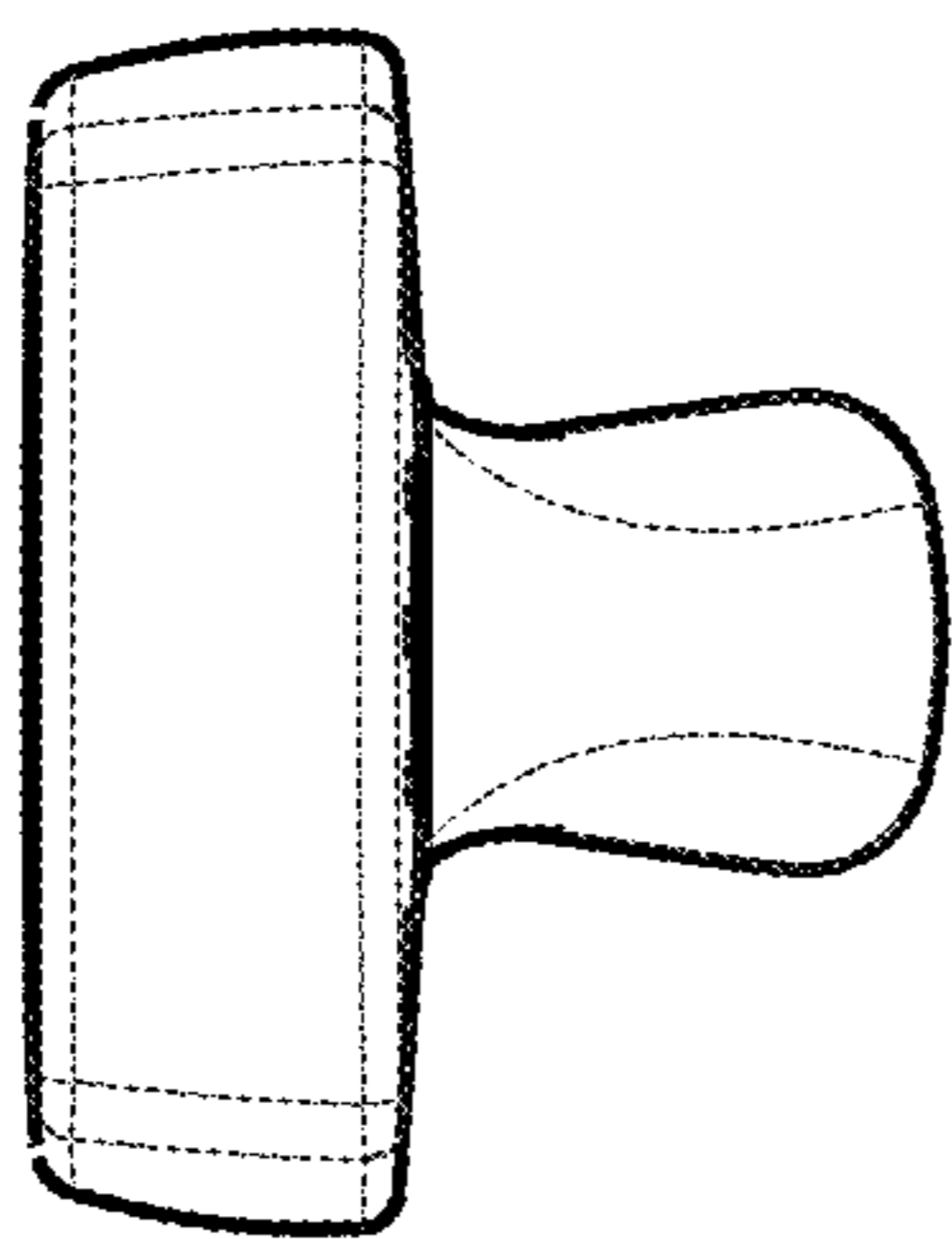

FIG - 7