



US00D879093S

(12) **United States Design Patent**
Khoeun

(10) **Patent No.:** **US D879,093 S**

(45) **Date of Patent:** **** Mar. 24, 2020**

(54) **AUTO STEREO MOUNTING DEVICE**

(71) Applicant: **Metra Electronics Corporation**, Holly Hill, FL (US)

(72) Inventor: **Pieckdey Khoeun**, Holly Hill, FL (US)

(73) Assignee: **Metra Electronics Corporation**, Holly Hill, FL (US)

(**) Term: **15 Years**

(21) Appl. No.: **29/699,555**

(22) Filed: **Jul. 26, 2019**

(51) **LOC (12) Cl.** **14-03**

(52) **U.S. Cl.**
USPC **D14/258**

(58) **Field of Classification Search**
USPC D12/192, 195, 415, 420; D14/496,
D14/498-506, 154, 157, 168-171,
D14/188-198, 257-258; 248/27.1, 27.3,
248/558; 455/347, 350
CPC B60R 11/02; B60K 37/04; B60K 37/06
See application file for complete search history.

(56) **References Cited**

U.S. PATENT DOCUMENTS

D512,670 S * 12/2005 Pfeiffer D12/192
D727,889 S * 4/2015 Fiore, IV D12/192

D756,347 S * 5/2016 Fiore, IV D14/258
D769,862 S * 10/2016 Quilling, II D14/258
D781,842 S * 3/2017 Quilling, II D14/258
D826,920 S * 8/2018 Wellard D14/258

* cited by examiner

Primary Examiner — Sandra L Morris

(74) *Attorney, Agent, or Firm* — J. Wiley Horton

(57) **CLAIM**

The ornamental design for an “auto stereo mounting device”, as shown and described.

DESCRIPTION

FIG. 1 is a perspective view of an auto stereo mounting device, showing my design;
FIG. 2 is a front elevation view of FIG. 1;
FIG. 3 is a rear elevation view of FIG. 1;
FIG. 4 is a left side elevation view of FIG. 1;
FIG. 5 is a right side elevation view of FIG. 1;
FIG. 6 is a top plan view of FIG. 1; and,
FIG. 7 is a bottom plan view of FIG. 1.
The broken lines shown in all views illustrate mounting features which form no part of the claimed design.

1 Claim, 7 Drawing Sheets

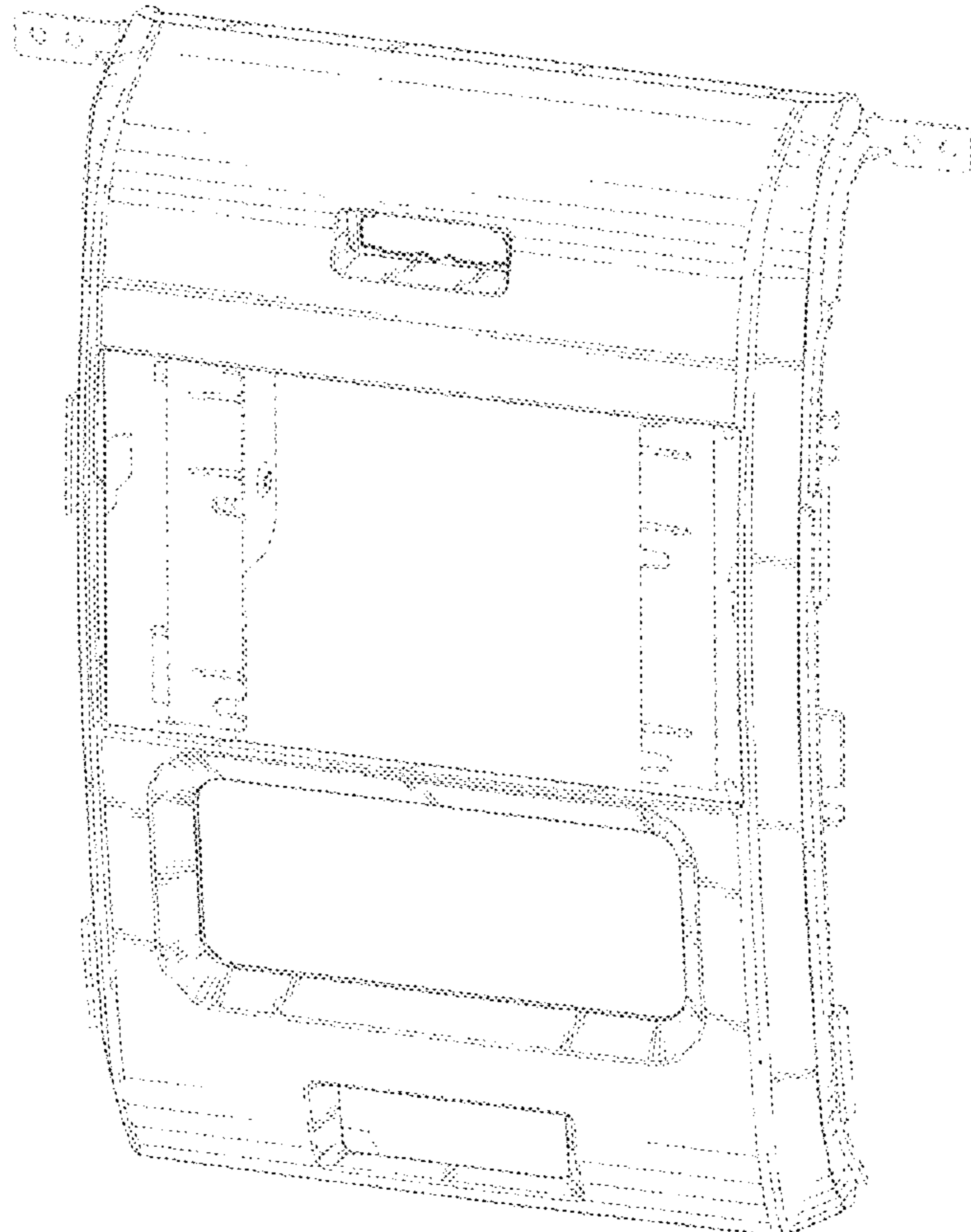

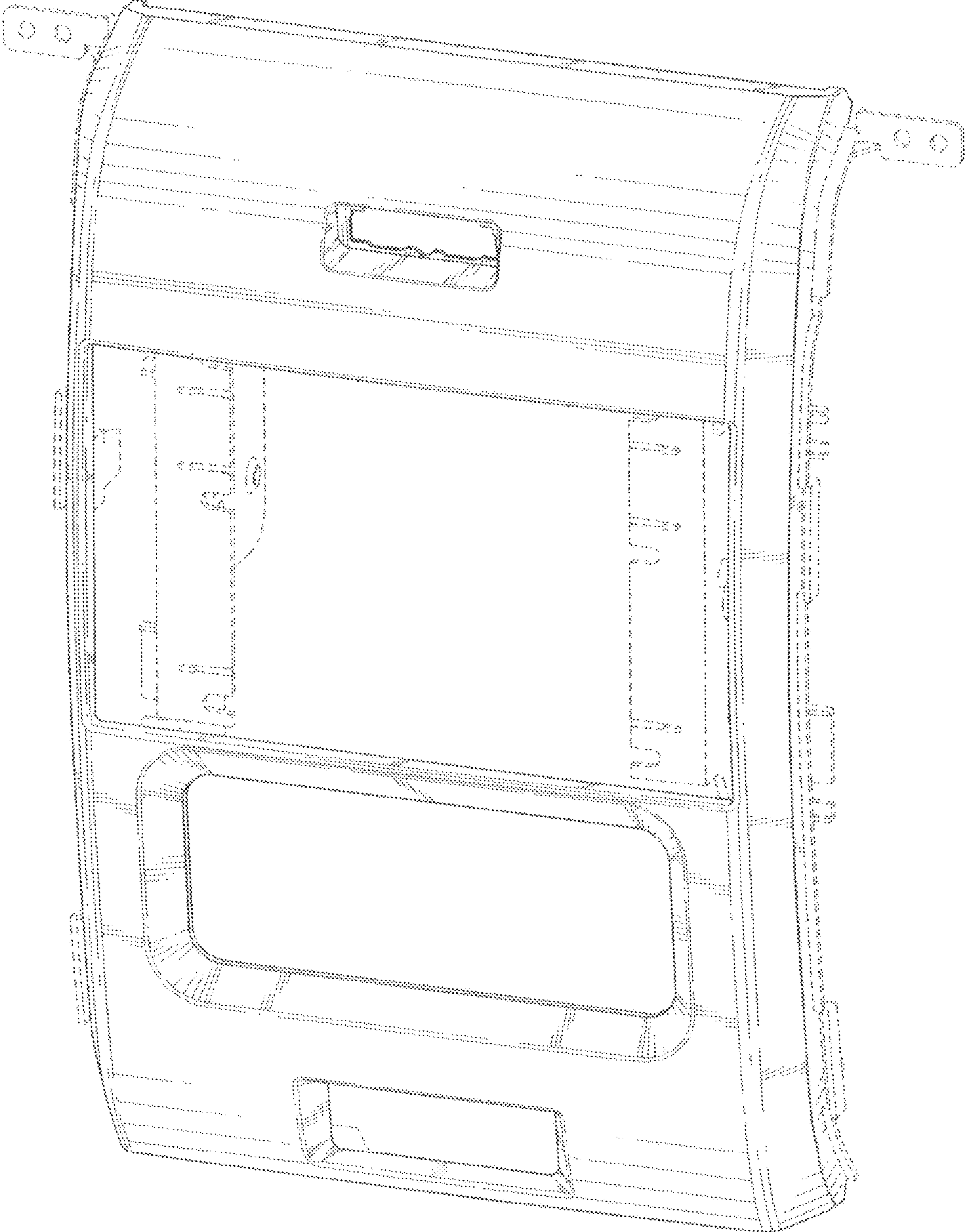

FIG. 1

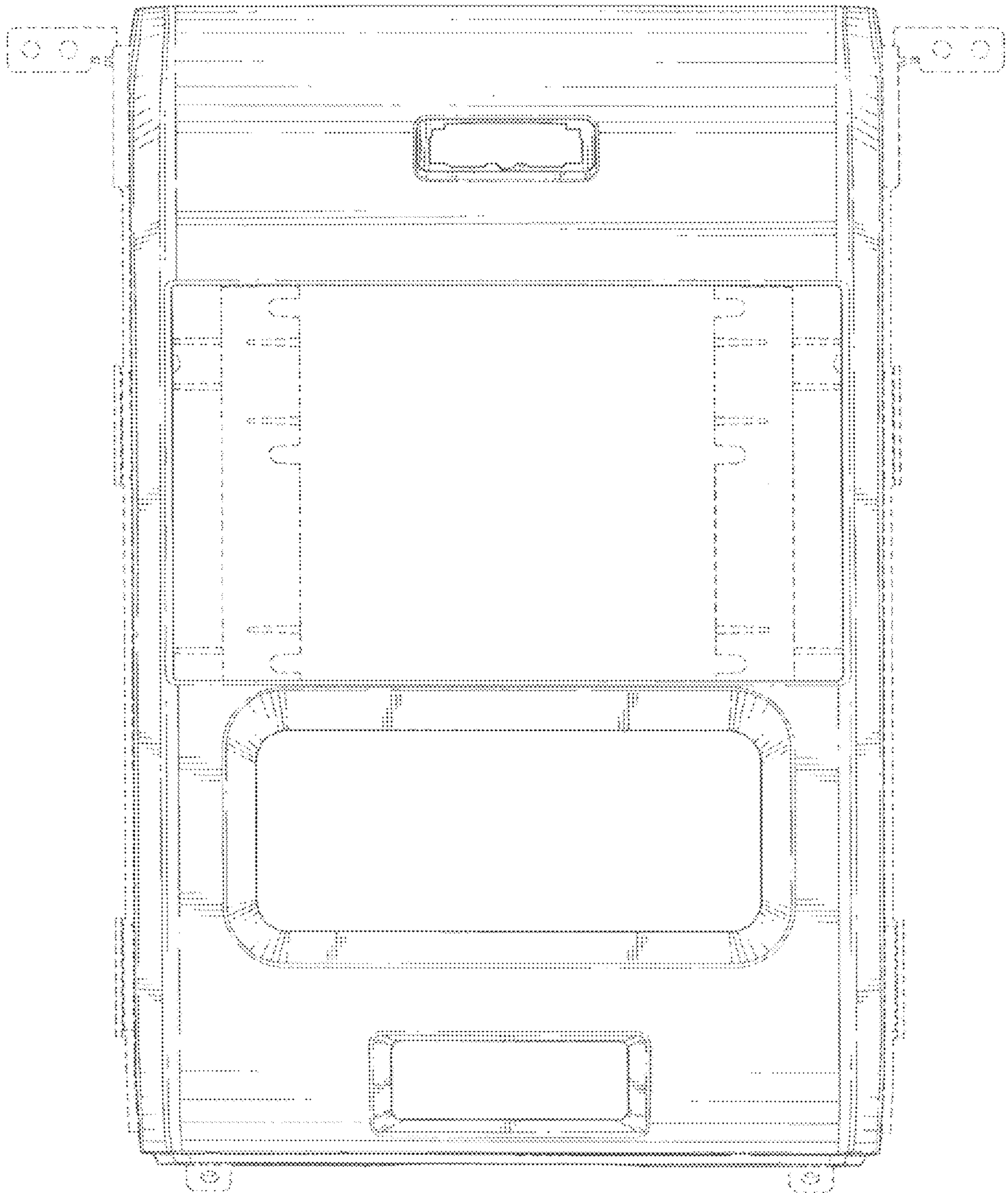

FIG. 2

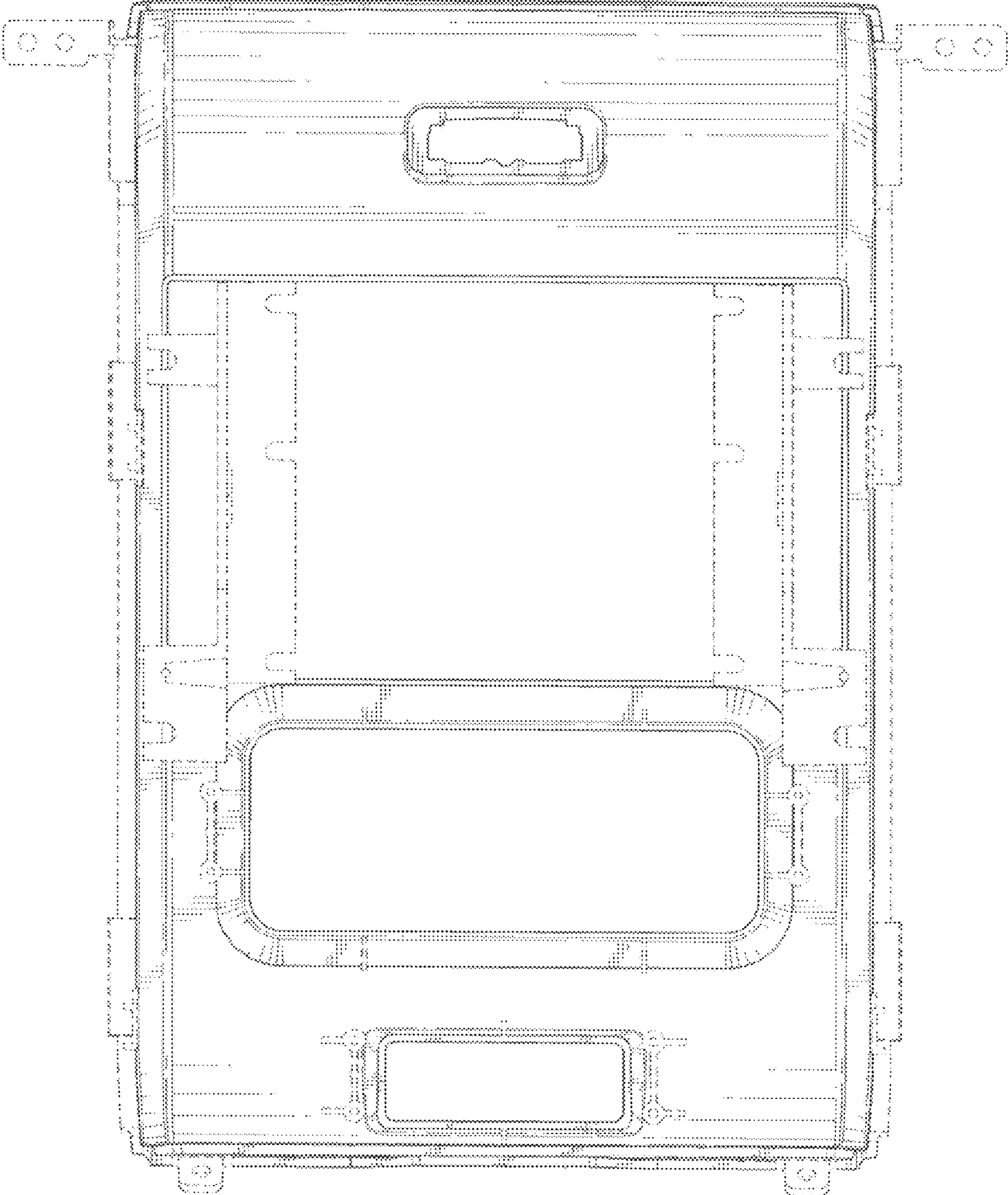

FIG. 3

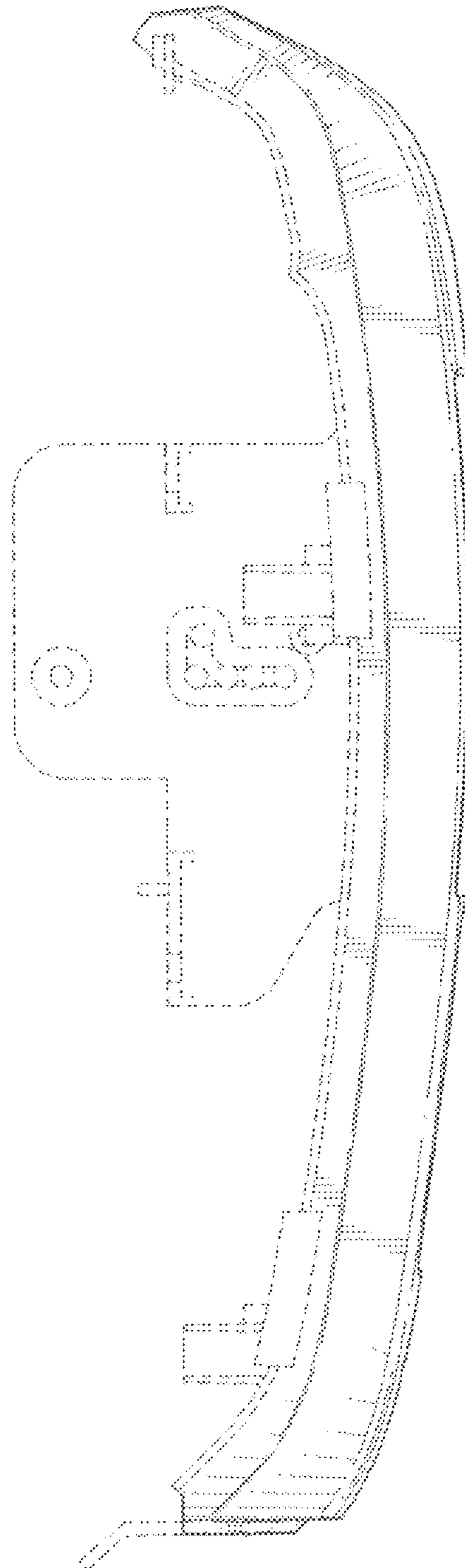

FIG. 4

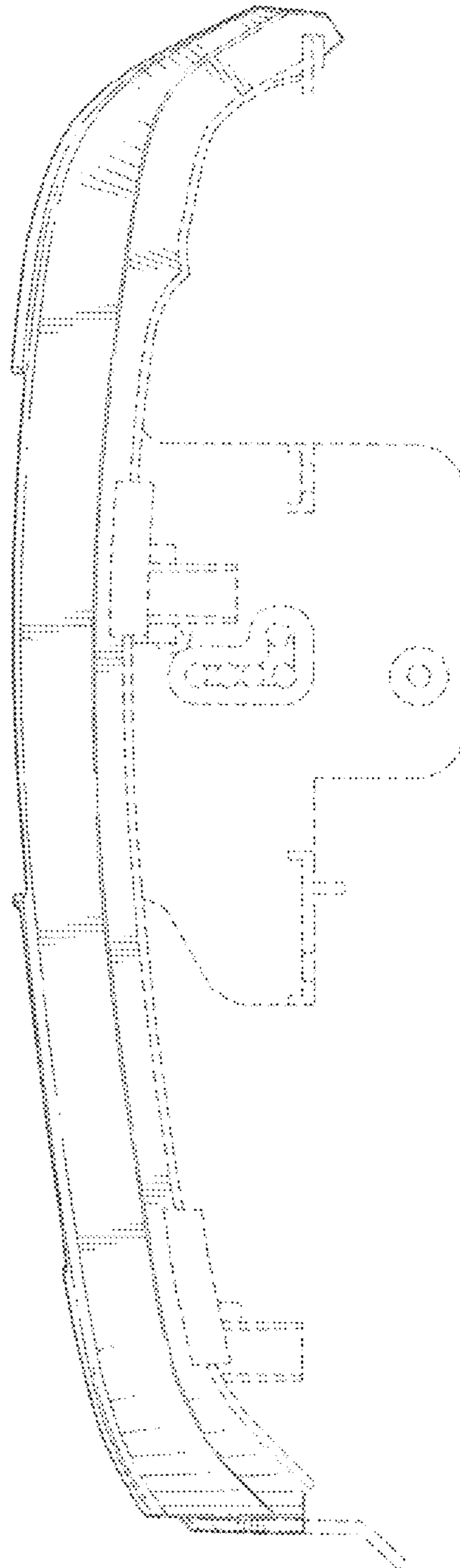

FIG. 5

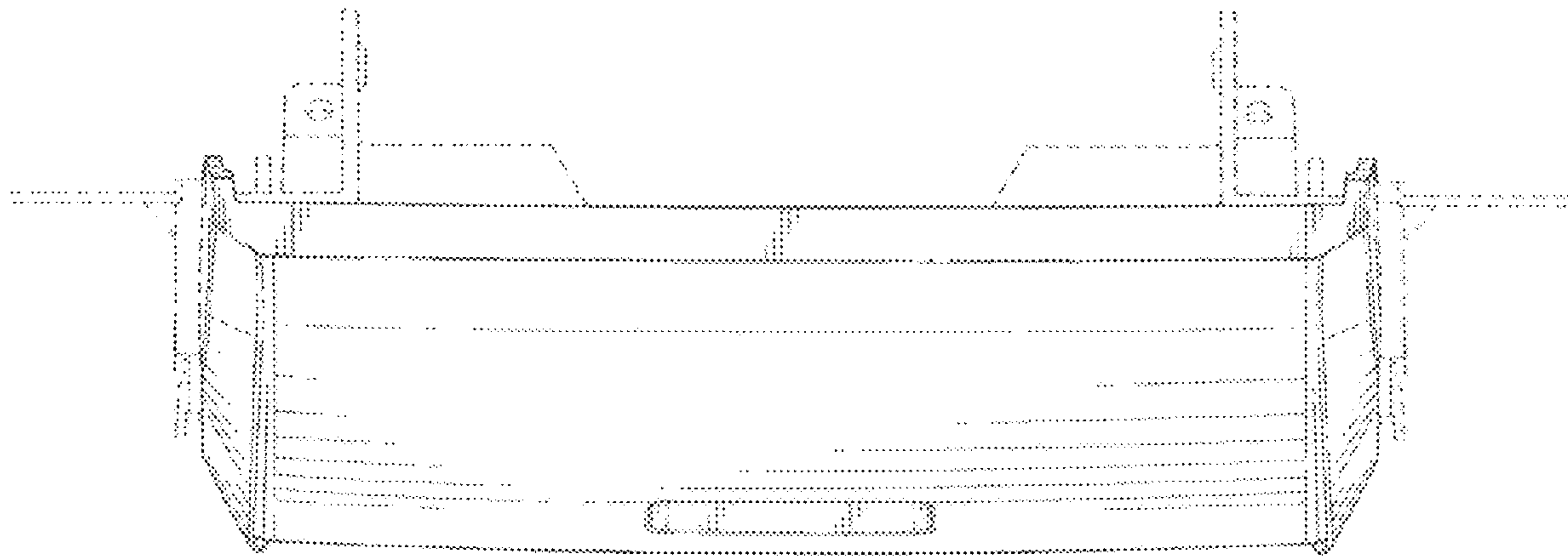

FIG. 6

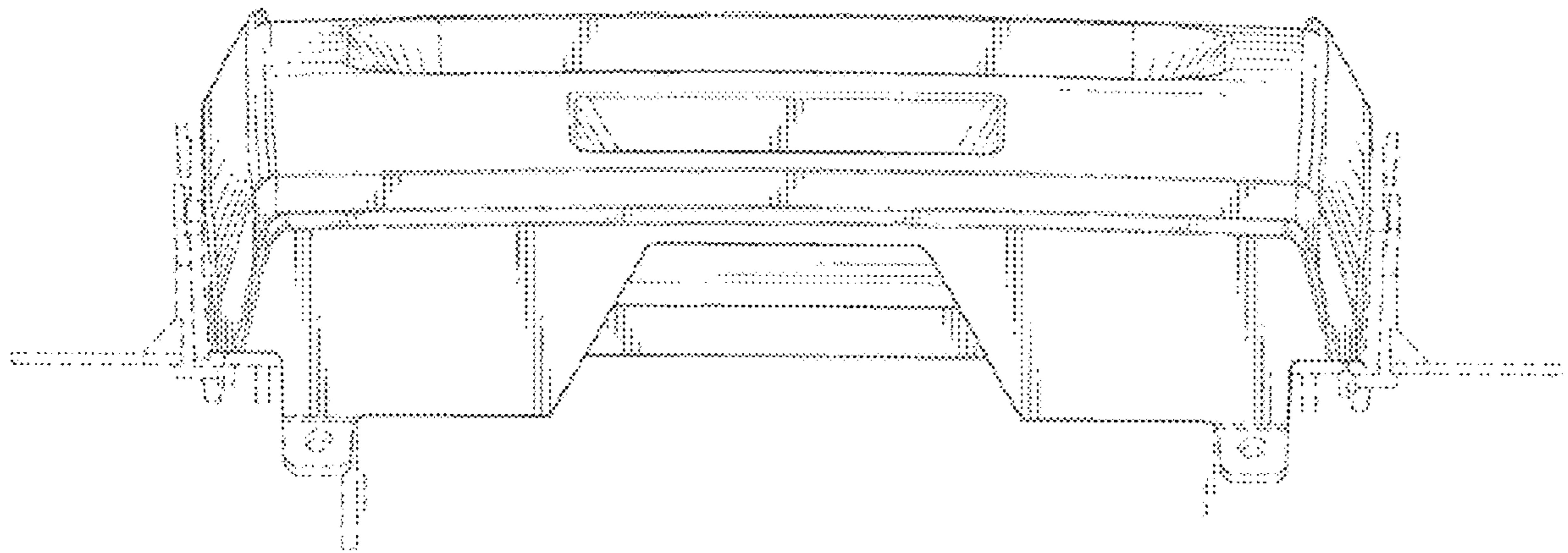

FIG. 7