



US00D878959S

(12) **United States Design Patent**
Tashjian

(10) **Patent No.:** **US D878,959 S**
(45) **Date of Patent:** **** Mar. 24, 2020**

(54) **EARRING**

(71) Applicant: **Venus by Maria Tash, Inc.**, New York, NY (US)

(72) Inventor: **Maria Tashjian**, New York, NY (US)

(73) Assignee: **Venus by Maria Tash, Inc.**, New York, NY (US)

(**) Term: **15 Years**

(21) Appl. No.: **29/698,128**

(22) Filed: **Jul. 15, 2019**

(51) **LOC (12) Cl.** **11-01**

(52) **U.S. Cl.**
USPC **D11/43**

(58) **Field of Classification Search**
USPC D11/40-48, 3, 4, 79, 80, 81, 86, 91, 92
CPC A44C 7/00; A44C 7/002; A44C 7/003;
A44C 7/004; A44C 7/005; A44C 7/006;
A44C 7/007; A44C 7/008; A44C 7/009;
A44C 5/00; A44C 5/0007; A44C 5/0023;
A44C 5/003; A44C 5/0038; A44C
5/0046; A44C 5/0053; A44C 5/0061;
A44C 5/0069; A44C 5/0076; A44C
5/0084; A44C 5/0092; A44C 1/00; A44C
3/00; A44C 3/001

See application file for complete search history.

(56) **References Cited**

U.S. PATENT DOCUMENTS

20,480 A	6/1858	Carpenter	
130,771 A	8/1872	Tryner	
292,810 A	2/1884	Hartmann	
D32,523 S *	4/1900	Zell	D11/43
D136,958 S	10/1943	Rubel	
D137,112 S	10/1943	Rubel	
D139,254 S	8/1944	Philippe	
D151,171 S	1/1948	Philippe	

D150,589 S *	8/1948	Trott	D11/43
D150,612 S *	8/1948	Katz	D11/44
D154,608 S	1/1949	Katz	
D156,271 S	7/1949	Philippe	
D156,312 S	8/1949	Bogoff	
D159,118 S	2/1950	Weinberg	
2,502,386 A	3/1950	Harry et al.	
D161,286 S	9/1950	Semensohn	
D161,289 S	9/1950	Semensohn	
D162,461 S	12/1950	Philippe	
D164,946 S	7/1951	Philippe	
D169,726 S	1/1953	Bell	
D170,349 S	5/1953	Bell	
D170,266 S *	8/1953	Katz	D11/43
D171,728 S	11/1953	Philippe	

(Continued)

OTHER PUBLICATIONS

[Online] 6.5mm Tassel Eternity Ring. <https://www.mariatash.com/jewelry/earlobe/1-4-diamond-tassel-eternity-ring.html?metal=White%20Gold>. Retrieved Aug. 31, 2019.*

(Continued)

Primary Examiner — Melanie Pellegrini
(74) *Attorney, Agent, or Firm* — Dentons US LLP

(57) **CLAIM**

An ornamental design for an earring, as shown and described.

DESCRIPTION

FIG. 1 is a front perspective view of an earring;
FIG. 2 is a front side view of the earring;
FIG. 3 is a back side view of the earring;
FIG. 4 is a left side view of the earring;
FIG. 5 is a right side view of the earring;
FIG. 6 is a bottom side view of the earring; and,
FIG. 7 is a top side view of the earring.
Broken lines shown in drawings illustrate portions of the earring that form no part of claimed design.

1 Claim, 7 Drawing Sheets

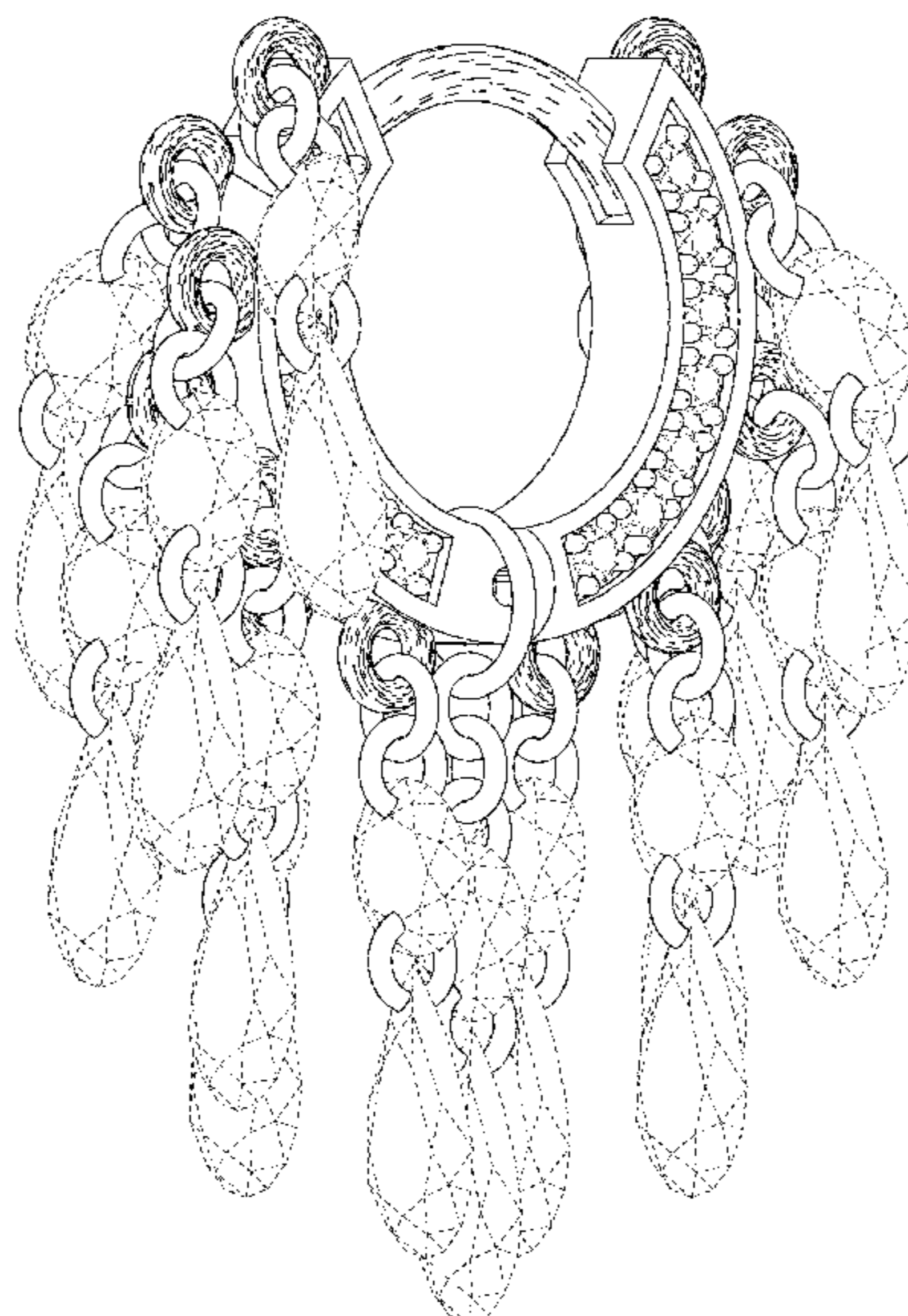

(56)

References Cited

U.S. PATENT DOCUMENTS

D171,708 S *	3/1954	Katz	D11/45	D287,577 S	1/1987	Lorberfeld
D173,990 S *	2/1955	Katz	D11/79	D290,446 S	6/1987	Bulgari
D176,782 S	1/1956	Katz		D292,501 S	10/1987	Jones
D177,121 S	3/1956	Katz		D292,560 S	11/1987	Di Maria et al.
D187,812 S	5/1960	Randall		D292,685 S	11/1987	Bulgari
3,382,589 A	5/1968	Dowling		D292,686 S	11/1987	Bulgari
D242,670 S	12/1976	Northup		D292,687 S	11/1987	Pesonen
D244,126 S	4/1977	Ladjimi		D292,780 S	11/1987	Galask
D244,920 S	7/1977	Kelman		D293,899 S	1/1988	Bulgari
D245,650 S	9/1977	Mueller et al.		D294,473 S	3/1988	Bulgari
D246,357 S	11/1977	Durante		D294,684 S	3/1988	Saraga
D247,614 S	3/1978	Kelman		D295,151 S	4/1988	Saraga
D248,380 S	7/1978	Burchett		D295,267 S	4/1988	Saraga
D248,458 S	7/1978	Gatof et al.		D298,611 S	11/1988	Saraga
D248,801 S	8/1978	Tafoya		D301,120 S	5/1989	Alviti
D249,129 S	8/1978	Fishman		D301,314 S	5/1989	Shapiro
D249,130 S	8/1978	Fishman		D301,561 S	6/1989	Westmoland
D249,252 S	9/1978	Gatof		D301,562 S	6/1989	Gaskill
D249,337 S	9/1978	DiOrio		D302,252 S	7/1989	Sykes
D250,456 S	12/1978	Fishman		D302,400 S	7/1989	Bulgari
D250,457 S	12/1978	Fishman		D302,401 S	7/1989	Weingast
D250,516 S	12/1978	Fishman		D303,230 S	9/1989	Westmoland
D250,517 S	12/1978	Fishman		D303,999 S	10/1989	Hansson
D251,715 S	5/1979	Fishman		D304,433 S	11/1989	McConnell, Jr.
D255,670 S	7/1980	Ambler		D304,532 S	11/1989	Campbell
D255,885 S	7/1980	Andrews		D304,533 S	11/1989	Campbell
D256,003 S	7/1980	Barr		D305,311 S	1/1990	Roberts
D257,023 S	9/1980	Barr		D305,996 S	2/1990	Bulgari
D257,024 S	9/1980	Barr		D307,989 S	5/1990	Stewart
D257,026 S	9/1980	Barr		D308,027 S	5/1990	Bulgari
D259,110 S	5/1981	Russell		D308,179 S	5/1990	Perlmutter et al.
D260,622 S	9/1981	Barr		D308,180 S	5/1990	Bulgari
D260,744 S	9/1981	Barr		D308,348 S	6/1990	Leopoldi
D261,245 S	10/1981	Epstein		D308,349 S	6/1990	Bulgari
D261,246 S	10/1981	Epstein		D308,650 S	6/1990	Bulgari
D261,247 S	10/1981	Epstein		D308,651 S	6/1990	Bulgari
D261,372 S	10/1981	Fried		D308,652 S	6/1990	Bulgari
D262,272 S	12/1981	Block		D308,838 S	6/1990	Bulgari
D264,060 S	4/1982	Epstein		D308,949 S	7/1990	Bulgari
D265,641 S	8/1982	Bongiorno		D308,950 S	7/1990	Greenhouse
D265,811 S	8/1982	Barr		D309,879 S	8/1990	Bulgari
D265,894 S	8/1982	Barr		D310,926 S	10/1990	Bass et al.
D265,895 S	8/1982	Barr		D310,979 S	10/1990	Perry
D267,241 S	12/1982	Bulgari		D311,502 S	10/1990	Bulgari
D268,016 S	2/1983	Block		D313,202 S	12/1990	Bulgari
D271,952 S	12/1983	Altman		D313,370 S	1/1991	Steiner
D272,327 S	1/1984	Bulgari		D315,211 S	3/1991	Reil
D272,994 S	3/1984	Serapiglia		D315,248 S	3/1991	Marshall
D273,371 S	4/1984	Bulgari		D315,654 S	3/1991	Hummel
D273,472 S	4/1984	Goldstein		D317,095 S	5/1991	Albers et al.
D274,418 S	6/1984	Bruce		D317,422 S	6/1991	Hardy
D274,709 S	7/1984	Bulgari		D318,197 S	7/1991	Butler
D278,987 S	5/1985	Zauderer		D319,801 S	9/1991	Bulgari
D279,082 S	6/1985	Bulgari		D320,573 S	10/1991	Bulgari
D279,874 S	7/1985	Moon		D320,798 S	10/1991	Holt
D279,875 S	7/1985	Moon		D320,799 S	10/1991	Holt
D279,876 S	7/1985	Moon		D320,951 S	10/1991	Bulgari
D279,877 S	7/1985	Moon		D321,149 S	10/1991	Royer
D279,878 S	7/1985	Moon		D321,150 S	10/1991	Bulgari
D279,879 S	7/1985	Moon		D322,890 S	1/1992	Drews
D279,880 S	7/1985	Moon		D324,350 S	3/1992	Owens, Jr.
D279,881 S	7/1985	Moon		D324,871 S	3/1992	Cordet et al.
D279,882 S	7/1985	Moon		D325,542 S	4/1992	Rubin et al.
D279,883 S	7/1985	Moon		D325,543 S	4/1992	Gueit
D279,884 S	7/1985	Moon		D326,066 S	5/1992	Sprague
D279,885 S	7/1985	Moon		D326,429 S	5/1992	Azrielant
4,538,429 A	9/1985	Bradford		D326,430 S	5/1992	Ortega
D281,149 S	10/1985	Krogh		D326,595 S	6/1992	Badgerow et al.
D281,767 S	12/1985	Mason		D326,828 S	6/1992	Bulgari
D282,647 S	2/1986	Bulgari		D327,030 S	6/1992	Young
D283,205 S	4/1986	Stephenson		D327,850 S	7/1992	Reil
D284,952 S	8/1986	Ricks		D327,982 S	7/1992	Williams
D286,758 S	11/1986	Bulgari		D329,341 S	9/1992	Rhodes
D287,230 S	12/1986	Bulgari		D329,565 S	9/1992	Kane et al.
D287,231 S	12/1986	Copeland		D330,872 S	11/1992	Ball
				5,161,391 A	11/1992	Lorberfeld
				D331,891 S	12/1992	Foley
				D332,025 S	12/1992	Caldwell et al.
				D333,279 S	2/1993	Fryklund

(56)

References Cited

U.S. PATENT DOCUMENTS

D334,003 S	3/1993	Vogelsang	D386,439 S	11/1997	Itzkowitz
D334,004 S	3/1993	Mandelbaum	D386,711 S	11/1997	Matye
D334,010 S	3/1993	Mandelbaum	D388,011 S	12/1997	Leonard
D334,153 S	3/1993	Mandelbaum	D388,012 S	12/1997	Matye
D334,353 S	3/1993	Lorberfeld	D388,013 S	12/1997	Rich
D334,855 S	4/1993	Harrington et al.	D388,357 S	12/1997	Montaquila
D335,959 S	6/1993	Blake	D388,734 S	1/1998	Montaquila
D335,995 S	6/1993	Soles	D388,735 S	1/1998	Webber
D336,574 S	6/1993	Rhodes	D389,085 S	1/1998	Montaquila
D336,621 S	6/1993	Vogelsang	D389,424 S	1/1998	Montaquila
D337,741 S	7/1993	Garfolo	D389,775 S	1/1998	Bulgari
D337,910 S	8/1993	Paluba	D389,776 S	1/1998	Montaquila
D337,963 S	8/1993	Gladorisi	D390,151 S	2/1998	Blum et al.
D338,117 S	8/1993	Caldwell et al.	D390,802 S	2/1998	Bulgari
D339,310 S	9/1993	Azrielant	D391,516 S	3/1998	Kothari
D342,691 S	12/1993	Milgrom	D391,756 S	3/1998	Horne
D342,894 S	1/1994	DiDomenico	D391,887 S	3/1998	Barr
D343,535 S	1/1994	Scott	D391,888 S	3/1998	Fox
D343,749 S	2/1994	Thompson	D392,041 S	3/1998	Reil
D344,910 S	3/1994	Nelson	D392,042 S	3/1998	Reil
D345,051 S	3/1994	Wills	D392,206 S	3/1998	Kothari
D346,343 S	4/1994	Haugh	D393,604 S	4/1998	Webber
D347,801 S	6/1994	Church	D393,812 S	4/1998	Silveri
D348,023 S	6/1994	Horner et al.	D394,021 S	5/1998	Matye
D348,854 S	7/1994	Salsgiver	D394,769 S	6/1998	Flint
D348,997 S	7/1994	Menner	D394,821 S	6/1998	Montaquila
D350,027 S	8/1994	Downes et al.	D394,823 S	6/1998	Vos
D352,190 S	11/1994	Tucker	D398,875 S	9/1998	Kothari
5,363,675 A	11/1994	Carter	D398,876 S	9/1998	Kothari
D353,120 S	12/1994	Pandel	D401,182 S	11/1998	Bulgari
D353,501 S	12/1994	Kral	D401,486 S	11/1998	Becker
D354,016 S	1/1995	Schubert	D401,884 S	12/1998	Gruosi
D354,927 S	1/1995	Andrau	D406,544 S	3/1999	Leonard
D356,751 S	3/1995	Gross et al.	D407,344 S	3/1999	Dubnicka
D358,067 S	5/1995	Graves	D408,315 S	4/1999	Lavalais
D358,210 S	5/1995	Reil	D408,317 S	4/1999	Karmeli
D359,254 S	6/1995	Gross et al.	D410,589 S	6/1999	Lagergren
D359,705 S	6/1995	Ball	D413,830 S	9/1999	Moten
D359,706 S	6/1995	DeAngelis	D415,446 S	10/1999	Kattan
D361,451 S	8/1995	Reiland	D417,636 S	12/1999	Ambar
D362,821 S	10/1995	Marchessault	D418,079 S	12/1999	Porcell
D363,218 S	10/1995	Mann	D419,908 S	2/2000	Leonard
D363,602 S	10/1995	Asher	D420,304 S	2/2000	Porcell
D363,683 S	10/1995	Spurgeon et al.	D420,934 S	2/2000	Montaquila
D365,779 S	1/1996	Archambeault	D423,979 S	5/2000	Montaquila
D366,729 S	1/1996	Reil	D424,468 S	5/2000	Bergagnini
D367,384 S	2/1996	DiFranco et al.	D424,695 S	5/2000	Reil
D368,671 S	4/1996	Ross	D427,540 S	7/2000	Calvani
D370,372 S	6/1996	Kraft	D429,658 S	8/2000	Biagi
D370,866 S	6/1996	Lange	D430,815 S	9/2000	Montaquila
D371,754 S	7/1996	Dunham	D434,877 S	12/2000	Harral
D371,982 S	7/1996	Price	D435,476 S	12/2000	Gruosi
D372,312 S	7/1996	Lange	D436,727 S	1/2001	Hsu
D372,380 S	8/1996	Montalbo et al.	D439,190 S	3/2001	Itzkowitz
D373,742 S	9/1996	Janice	D439,193 S	3/2001	Gruosi
D374,637 S	10/1996	Esser	D441,313 S	5/2001	Turner
D374,837 S	10/1996	Austin	D450,615 S	11/2001	Ambar
D375,703 S	11/1996	Lowe et al.	D454,810 S	3/2002	Knee
D376,335 S	12/1996	Shechter	D455,974 S	4/2002	Torres
D376,476 S	12/1996	Tepen et al.	D458,182 S	6/2002	Gruosi
D376,768 S	12/1996	Ross	D461,409 S	8/2002	Kardush
D377,461 S	1/1997	Kloppenburg, Jr. et al.	D468,494 S	1/2003	Holloway
D378,360 S	3/1997	Montaquila	D472,497 S	4/2003	Bonnet
D378,808 S	4/1997	Shechter	D474,353 S	5/2003	Gist Skinner
D379,305 S	5/1997	VanFleet	D479,145 S	9/2003	Newman
D379,601 S	6/1997	Itzkowitz	D481,326 S	10/2003	Bonifacio
D380,978 S	7/1997	Matye	D481,646 S	11/2003	Bonifacio
D381,925 S	8/1997	Bergannini	D484,822 S	1/2004	Crova
5,660,061 A	8/1997	Magida	D485,203 S	1/2004	Pachachi
D383,699 S	9/1997	Bulgari	D485,204 S	1/2004	Sandberg
D383,700 S	9/1997	Bulgari	D486,091 S	2/2004	Pachachi
D383,706 S	9/1997	Archambault	D486,416 S	2/2004	Pachachi
D383,998 S	9/1997	Condron	D487,408 S	3/2004	Coin
D385,814 S	11/1997	Kilpatrick	D489,639 S	5/2004	Castle
D386,108 S	11/1997	Montaquila	D506,406 S	6/2005	Sandberg
			D507,985 S	8/2005	Sandberg
			D511,310 S	11/2005	Gruosi
			D513,392 S	1/2006	Arbore
			D515,452 S	2/2006	Arbore

(56)

References Cited

U.S. PATENT DOCUMENTS

D516,453 S	3/2006	Kayamori et al.	D637,104 S	5/2011	Papadimitriou
D520,897 S	5/2006	Sandberg	D639,692 S	6/2011	Papadimitriou
D531,078 S	10/2006	Chan	D639,694 S	6/2011	Papadimitriou
D533,803 S	12/2006	Corso	D640,585 S	6/2011	Nolan
D535,580 S	1/2007	Arbore	D642,086 S	7/2011	Modi
D537,377 S	2/2007	Becker	7,980,095 B1	7/2011	Masterson
D537,750 S	3/2007	Allin	D647,421 S	10/2011	Nolan
D537,751 S	3/2007	Becker	D648,242 S	11/2011	Hara
D538,195 S	3/2007	Williams	D653,151 S	1/2012	Bennett
D538,701 S	3/2007	Williams	D655,193 S	3/2012	Janssen
D539,690 S	4/2007	Allin	D658,090 S	4/2012	Papadimitriou
D540,212 S	4/2007	Becker	D658,529 S	5/2012	Papadimitriou
D541,694 S	5/2007	Ping	D658,530 S	5/2012	Papadimitriou
D542,170 S	5/2007	Bruno et al.	D659,583 S	5/2012	Papadimitriou
D542,696 S	5/2007	Cilluffo	D660,743 S	5/2012	Crafton
7,217,014 B2	5/2007	Nielson	D660,744 S	5/2012	Papadimitriou
D544,389 S	6/2007	Ooten	D660,745 S	5/2012	Papadimitriou
D545,716 S	7/2007	Bulgari	D661,219 S	6/2012	Papadimitriou
D549,125 S	8/2007	Malone	D662,005 S	6/2012	Bennett
D549,607 S	8/2007	Mouclier	D664,061 S	7/2012	Papadimitriou
D550,583 S	9/2007	Karachi-Langane	D664,062 S	7/2012	Papadimitriou
D554,020 S	10/2007	Bruno et al.	D665,297 S	8/2012	Parris
D555,030 S	11/2007	Hardy	D665,298 S	8/2012	Papadimitriou
D556,620 S	12/2007	Chan	D665,693 S	8/2012	Bennett
D562,718 S	2/2008	Wong	D668,986 S	10/2012	Friedman
D567,132 S	4/2008	Bulgari	D669,386 S	10/2012	Papadimitriou
D567,133 S	4/2008	Crawford	D669,387 S	10/2012	Kwon
D567,134 S	4/2008	Bulgari	D670,191 S	11/2012	Bennett
D567,702 S	4/2008	Walters	D671,439 S	11/2012	Bennett
D574,745 S	8/2008	Nolan	D672,681 S	12/2012	Bennett
D574,746 S	8/2008	Nolan	D673,070 S	12/2012	Papadimitriou
D588,490 S	3/2009	Momjian	D674,719 S	1/2013	Bennett
D591,192 S	4/2009	Nolan	D674,720 S	1/2013	Bennett
D592,538 S	5/2009	Momjian	D676,349 S	2/2013	Papadimitriou
D599,694 S	9/2009	Nolan	D678,101 S	3/2013	Parvex
D599,695 S	9/2009	Nolan	D680,024 S	4/2013	Le Bail
D600,586 S	9/2009	Nolan	D684,085 S	6/2013	Papadimitriou
D601,056 S	9/2009	Atallah	D689,392 S	9/2013	Parvex
D601,917 S	10/2009	Nolan et al.	D692,261 S	10/2013	Sharp
D603,289 S	11/2009	Lebail	D692,342 S	10/2013	Bennett
D605,968 S	12/2009	Colombani	D693,260 S	11/2013	Papadimitriou
D605,970 S	12/2009	Colombani	D693,721 S	11/2013	Papadimitriou
D606,443 S	12/2009	Traglio	D694,146 S	11/2013	Beeson
D606,896 S	12/2009	Traglio	D703,084 S	4/2014	Parvex
D607,363 S	1/2010	Traglio	D707,151 S	6/2014	Kimbrough et al.
D607,364 S	1/2010	Marks	D707,152 S	6/2014	Shields
D608,239 S	1/2010	McCarty-O'Brien	D708,540 S	7/2014	Norendzayan
D610,033 S	2/2010	Colombani	D708,541 S	7/2014	Norendzayan
D610,934 S	3/2010	Papadimitriou	D709,792 S	7/2014	Singer et al.
D610,935 S	3/2010	Papadimitriou	8,763,357 B1	7/2014	Arnone
D614,073 S	4/2010	Cabarbaye	D714,673 S	10/2014	Bradley
D619,030 S	7/2010	Papadimitriou	D716,685 S	11/2014	Oh
D619,488 S	7/2010	Gruosi	D718,649 S	12/2014	Harel-Klein et al.
D620,833 S	8/2010	Papadimitriou	D718,650 S	12/2014	Weems
D621,279 S	8/2010	Janssen	D720,647 S	1/2015	Kwon
D621,281 S	8/2010	Janssen	D722,907 S	2/2015	Miceli
D621,721 S	8/2010	Walker-Spry	D726,577 S	4/2015	Weems
D623,081 S	9/2010	Papadimitriou	D727,773 S	4/2015	Kwon
D624,843 S	10/2010	Colombani	D727,774 S	4/2015	Kwon
D626,881 S	11/2010	Meneau	D727,775 S	4/2015	Yatsugi-Kang
D627,252 S	11/2010	Warren	D727,776 S	4/2015	Weems
D627,253 S	11/2010	Meneau	D727,778 S	4/2015	Levinson et al.
D628,113 S	11/2010	Papadimitriou	D728,410 S	5/2015	Yatsugi-Kang
D628,114 S	11/2010	Papadimitriou	D729,107 S	5/2015	Riviere
D629,325 S	12/2010	Papadimitriou	D729,108 S	5/2015	Kwon
D630,965 S	1/2011	Papadimitriou	D731,347 S	6/2015	Zeuner
D630,967 S	1/2011	Lebail	D733,574 S	7/2015	Walker-Spry
D631,383 S	1/2011	Papadimitriou	D737,717 S	9/2015	Weems
D631,384 S	1/2011	Papadimitriou	D738,774 S	9/2015	Vartanian
D631,385 S	1/2011	Lebail	D738,775 S	9/2015	Vartanian
D632,605 S	2/2011	Marchand	D740,153 S	10/2015	Vartanian
D634,214 S	3/2011	Janssen	D740,154 S	10/2015	Vartanian
D635,608 S	4/2011	Gray	D742,779 S	11/2015	Traglio
D636,696 S	4/2011	Lebail	D743,293 S	11/2015	Weems
D637,103 S	5/2011	Lebail	D746,719 S	1/2016	Weems
			D747,665 S	1/2016	Hooper
			D747,666 S	1/2016	Yatsugi-Kang
			D748,003 S	1/2016	Vartanian
			D748,004 S	1/2016	Vartanian

(56)

References Cited

U.S. PATENT DOCUMENTS

D748,005 S 1/2016 Vartanian
 D748,006 S 1/2016 Vartanian
 D748,522 S 2/2016 Vartanian
 D748,524 S 2/2016 Vartanian
 D748,525 S * 2/2016 Yatsugi-Kang D11/42
 D749,456 S 2/2016 Gruosi
 D749,978 S 2/2016 Holubar
 D749,981 S 2/2016 Vartanian
 D751,451 S 3/2016 Kwon
 D752,472 S 3/2016 Riviere
 D753,012 S 4/2016 Yatsugi-Kang
 D753,015 S 4/2016 Crafton et al.
 D753,533 S 4/2016 Roth
 D758,911 S 6/2016 Kwon
 D760,110 S 6/2016 Miller
 D760,618 S 7/2016 Yatsugi-Kang
 D761,658 S 7/2016 Walker-Spry
 D763,720 S 8/2016 Yatsugi-Kang
 D764,342 S 8/2016 Bulgari
 D764,343 S 8/2016 Bulgari
 D772,099 S 11/2016 Roth
 D778,200 S 2/2017 Iacomucci
 D780,034 S 2/2017 Kwon
 D780,036 S 2/2017 Silvestri
 D780,037 S 2/2017 Magallanes-Leal
 D780,038 S 2/2017 Riviere
 D780,039 S 2/2017 Abdourahim
 D780,040 S 2/2017 Galli
 D781,739 S 3/2017 Nickels
 D782,934 S 4/2017 Riviere
 D783,442 S 4/2017 Yatsugi-Kang
 D784,846 S 4/2017 Abdourahim
 D785,491 S 5/2017 Yatsugi-Kang
 D789,826 S 6/2017 Riviere
 D792,266 S 7/2017 Hardy
 D792,803 S 7/2017 Abdourahim
 D796,372 S 9/2017 Gruosi
 D797,599 S 9/2017 Yatsugi-Kang
 D800,012 S 10/2017 Oliner-Katz
 D807,774 S 1/2018 Hardy
 D808,851 S 1/2018 Kwon
 D809,419 S 2/2018 Hardy
 D809,960 S 2/2018 Marchand
 D809,961 S 2/2018 Magallanes-Leal
 D809,962 S 2/2018 Le Bail
 D810,612 S 2/2018 Corey et al.
 D811,928 S 3/2018 Stern
 D812,510 S 3/2018 Levy
 D813,080 S 3/2018 Sallard
 D813,708 S 3/2018 Lane
 D813,709 S 3/2018 Dholakiya
 D814,291 S 4/2018 Taylor
 D815,556 S 4/2018 Stern

D816,538 S 5/2018 Nickels
 D818,867 S 5/2018 Heller
 D820,145 S 6/2018 Galli
 D822,531 S 7/2018 Stern
 D822,532 S 7/2018 Stern
 D824,276 S 7/2018 Bloatacker
 D824,277 S 7/2018 Sallard
 D826,080 S 8/2018 Gentile et al.
 D834,988 S 12/2018 Silvestri
 D836,018 S 12/2018 An
 D842,753 S 3/2019 Morin
 D846,423 S 4/2019 Buccellati
 D847,683 S 5/2019 Buccellati
 D851,532 S 6/2019 Yamada
 D852,079 S 6/2019 Sivriere
 2008/0022720 A1 1/2008 Ciccone
 2010/0212356 A1 8/2010 Namiki
 2011/0083471 A1 4/2011 Chough
 2013/0186134 A1 7/2013 Goldstein
 2014/0150496 A1 6/2014 Briggs-Jenkins
 2017/0079388 A1 3/2017 Kita
 2018/0343990 A1 12/2018 Repposi

OTHER PUBLICATIONS

[Online] "6.5mm Gold Tassel Eternity Single Earring" <https://www.freepeople.com/shop/65mm-gold-tassel-eternity-single-earring/>. Retrieved Aug. 31, 2019.*
 Maria Tash Earrings, <https://mariatash.com/jewelry/earlobe.html>; downloaded from Internet Jun. 30, 2019 (35 pages).
 Blue Buddha Boutique, Cre8time Movement: Jewelry Project in 8 steps of Less—Coiled Earrings, <http://www.bluebuddhaboutique.com/blog/2013/04/cre8time-movement-jewelry-project-in-8-steps-or-less-coiled-earrings/>, Apr. 6, 2013 (6 pages).
 Casasconil.info Chandelier, Glass Crystal Chandelier Drops, Jul. 28, 2018 (54 pages).
 Crafty Blog Stalker, How to Make Crystal Drop Earrings, <https://thecraftyblogstalker.com/diy-rhinestone-drop-earrings/>, (12 pages).
 Maria Tash, 16mm Diamond In-Set Lotus Coronet Hoops Pair, <https://www.mariatash.com/16mm-diamond-inet-lotcoronet-hoops-pair.html?metal=White%20Gold>. Retrieved by USPTO Examiner Sep. 9, 2019.
 Maria Tash, 6.5mm Diamond Eternity Ring and Two Cuffs, <https://www.mariatash.com/jewelry/earlobe/diamond-1-4-tripie-eternity-ringnd-two-cuffs-earlobe.html?metal=White%20Gold>. Retrieved by USPTO Examiner Sep. 9, 2019.
 Maria Tash, Diamond Delia and Marquise Dangle Chain Orbital, <https://www.mariatash.com/jewelry/earlobe/diamond-delia-marquisend-rounds-chainnd-dangles-orbital.html?metal=Rose%20Gold>. Retrieved by USPTO Examiner Aug. 17, 2019.
 Maria Tash, Diamond Eternity Ring and Cuff, <https://modesens.com/product/maria-tash-diamond-eternity-ringnd-cuff-18kt-rose-goldingle-earring-pink-5724852/> Retrieved by USPTO Examiner Sep. 9, 2019.

* cited by examiner

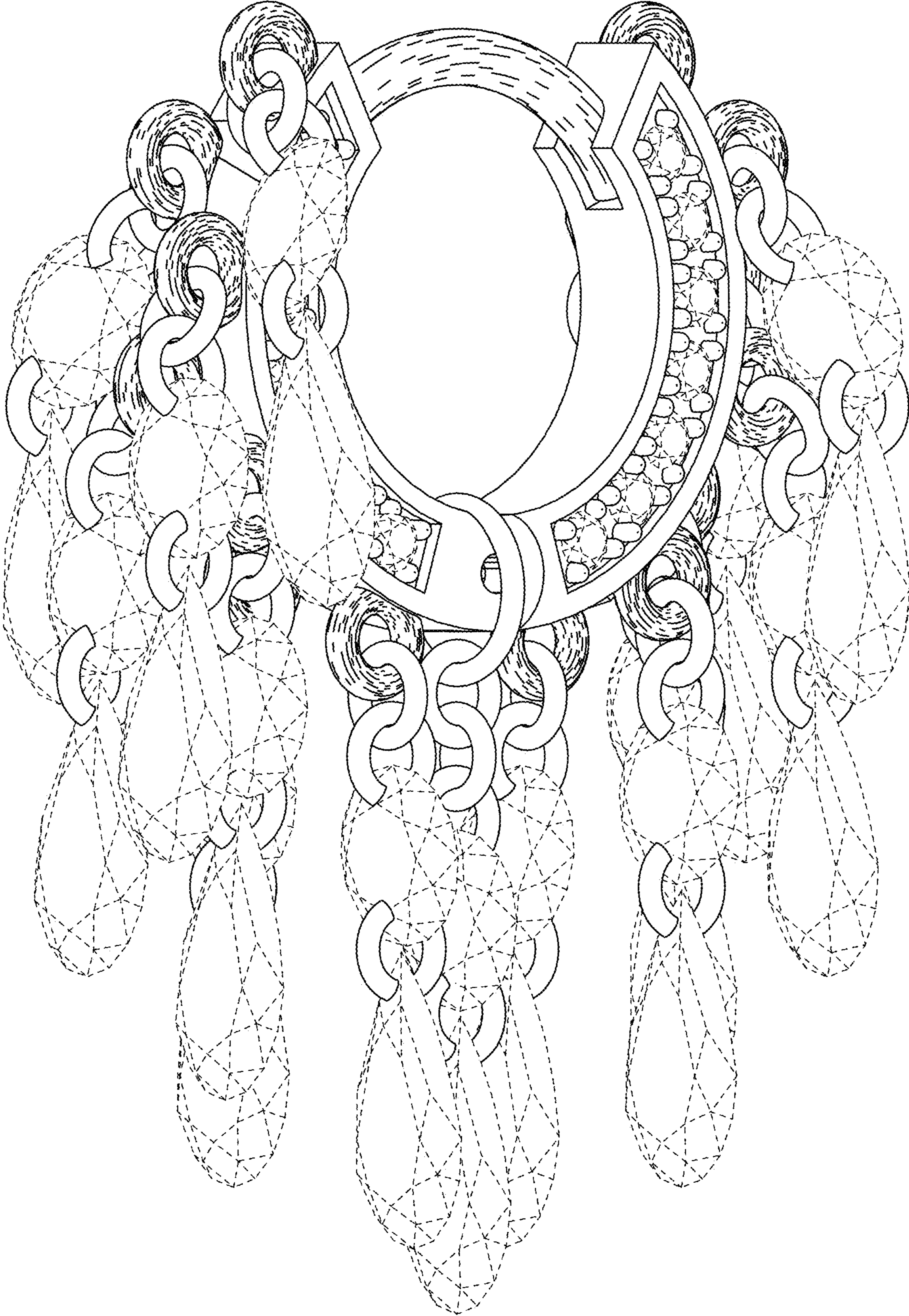

FIG. 1

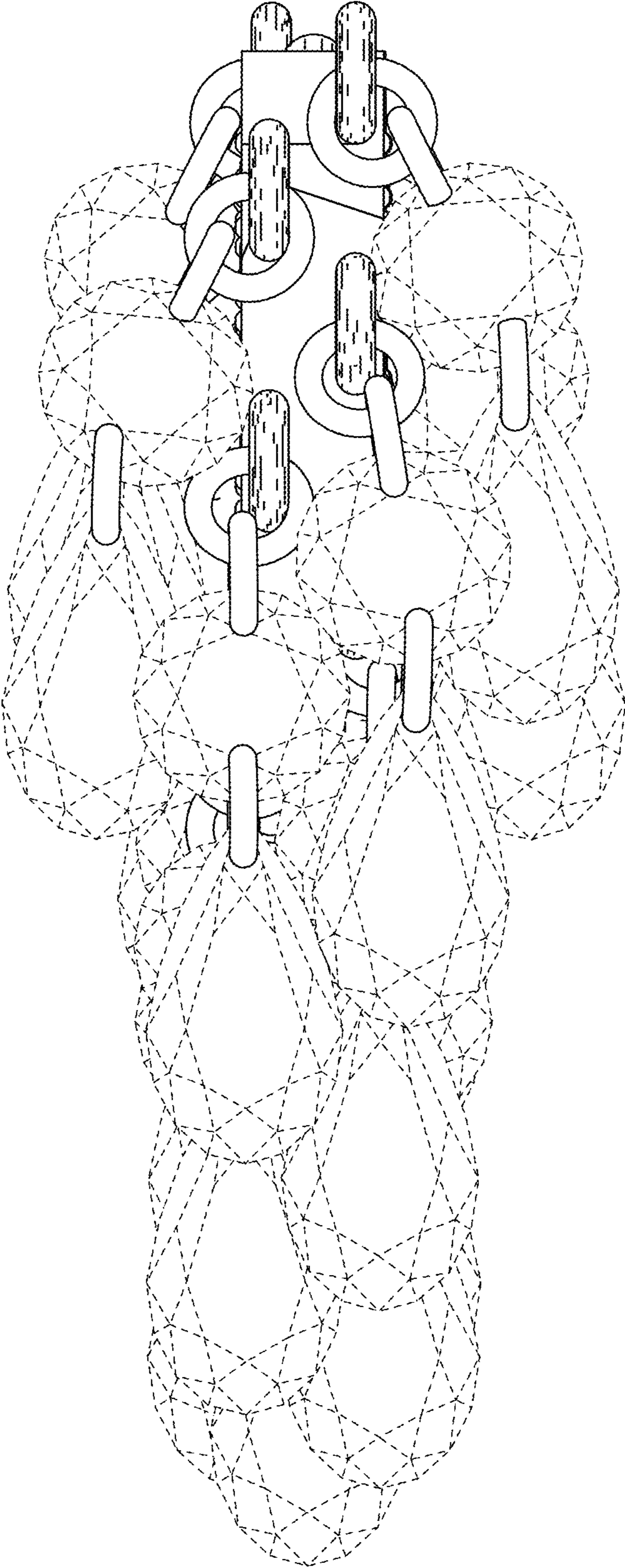

FIG. 2

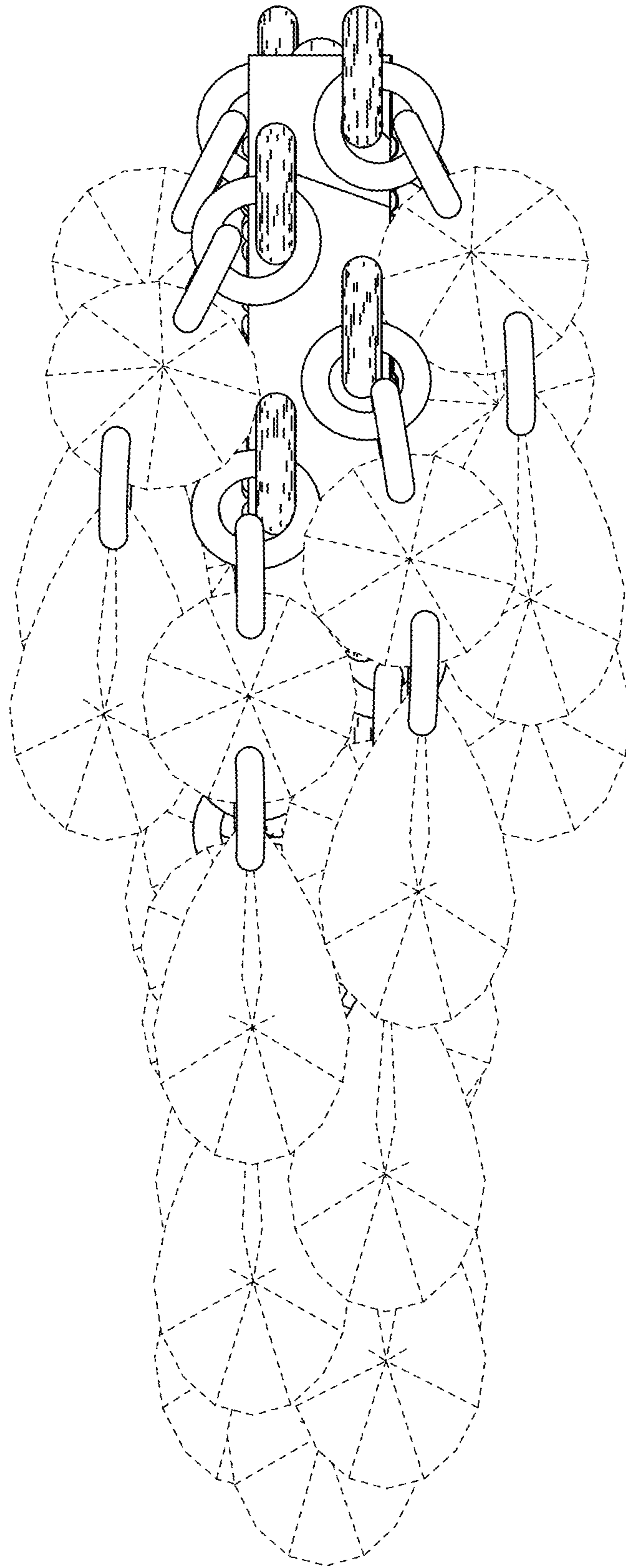

FIG. 3

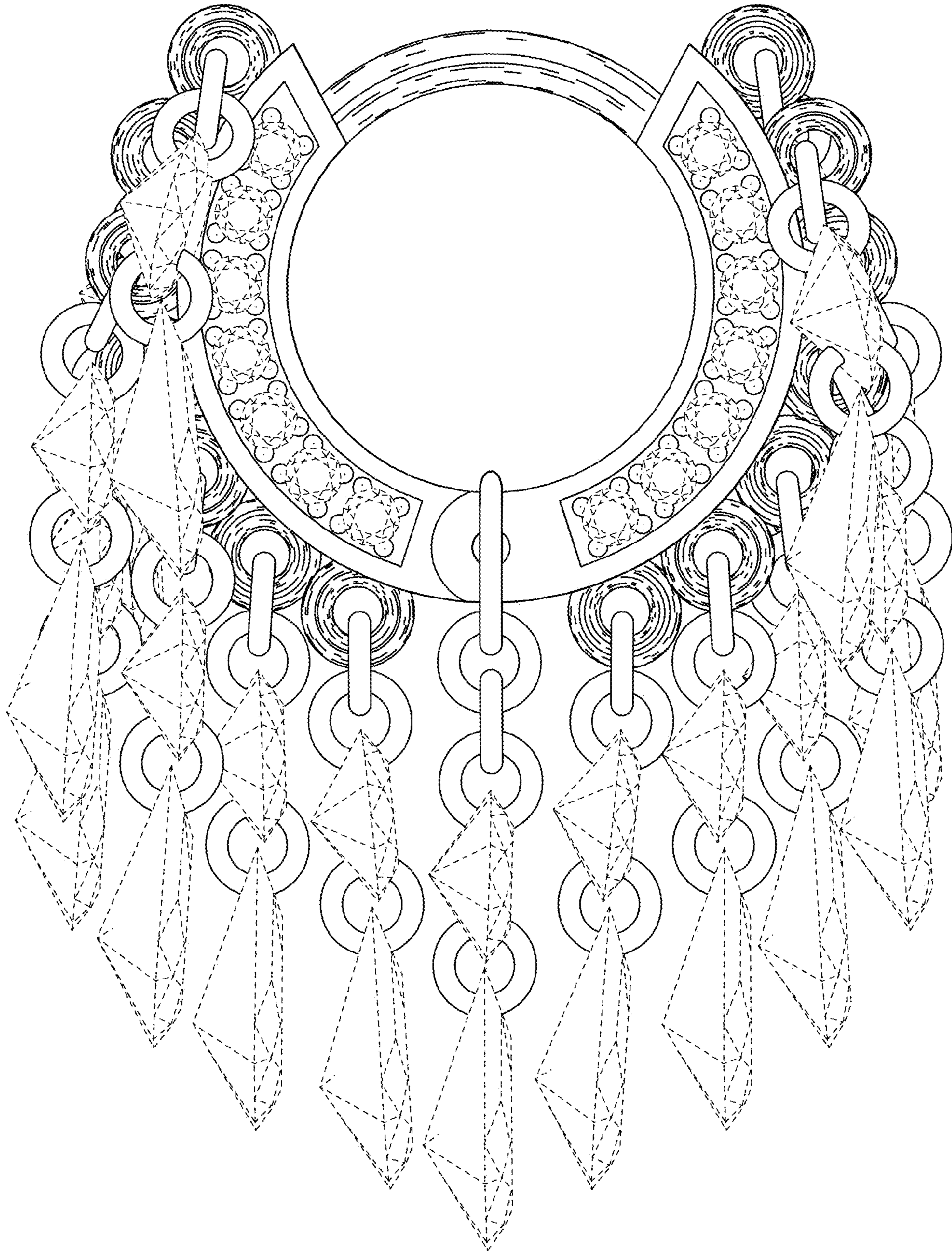

FIG. 4



FIG. 5

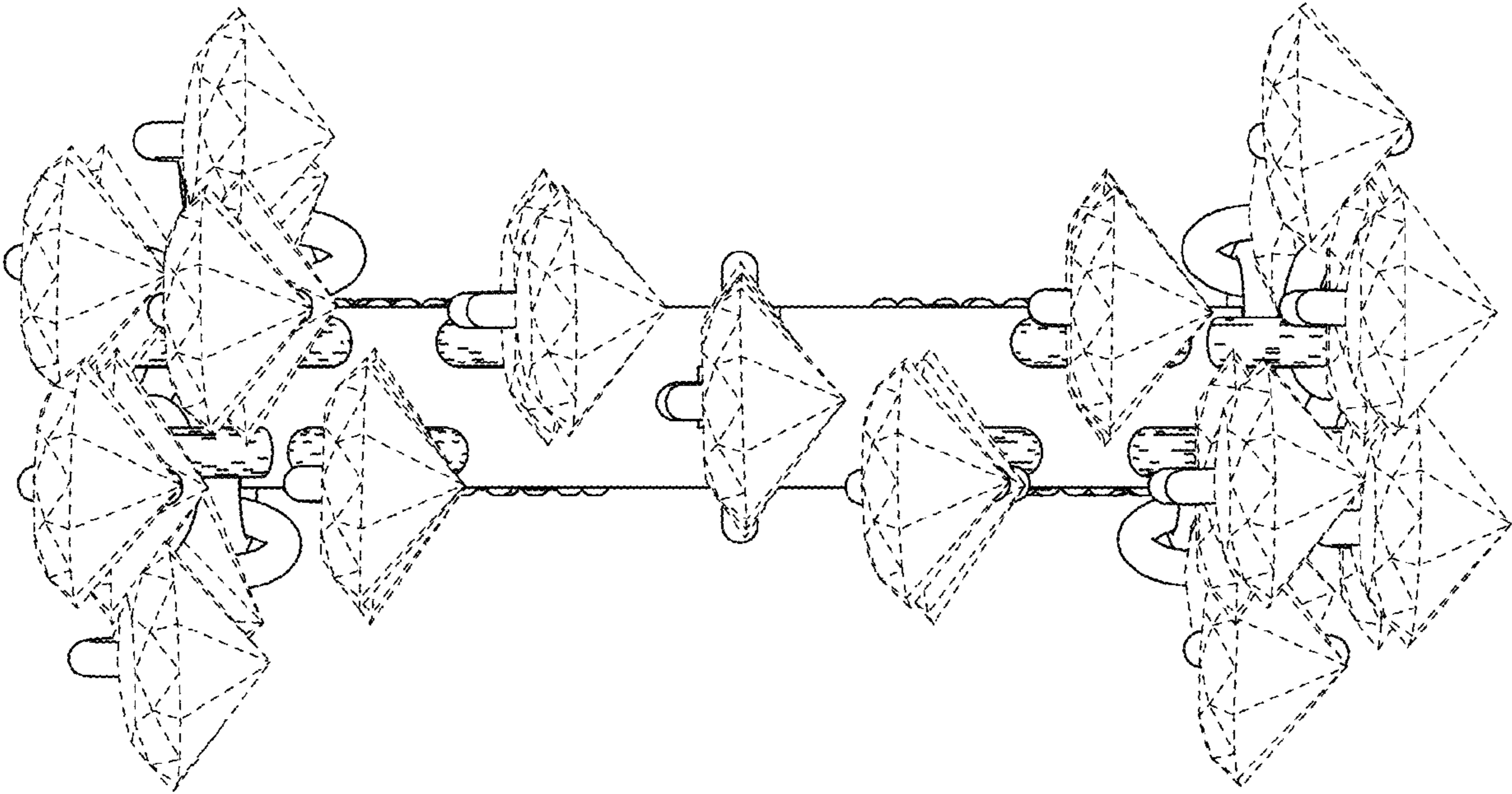

FIG. 6

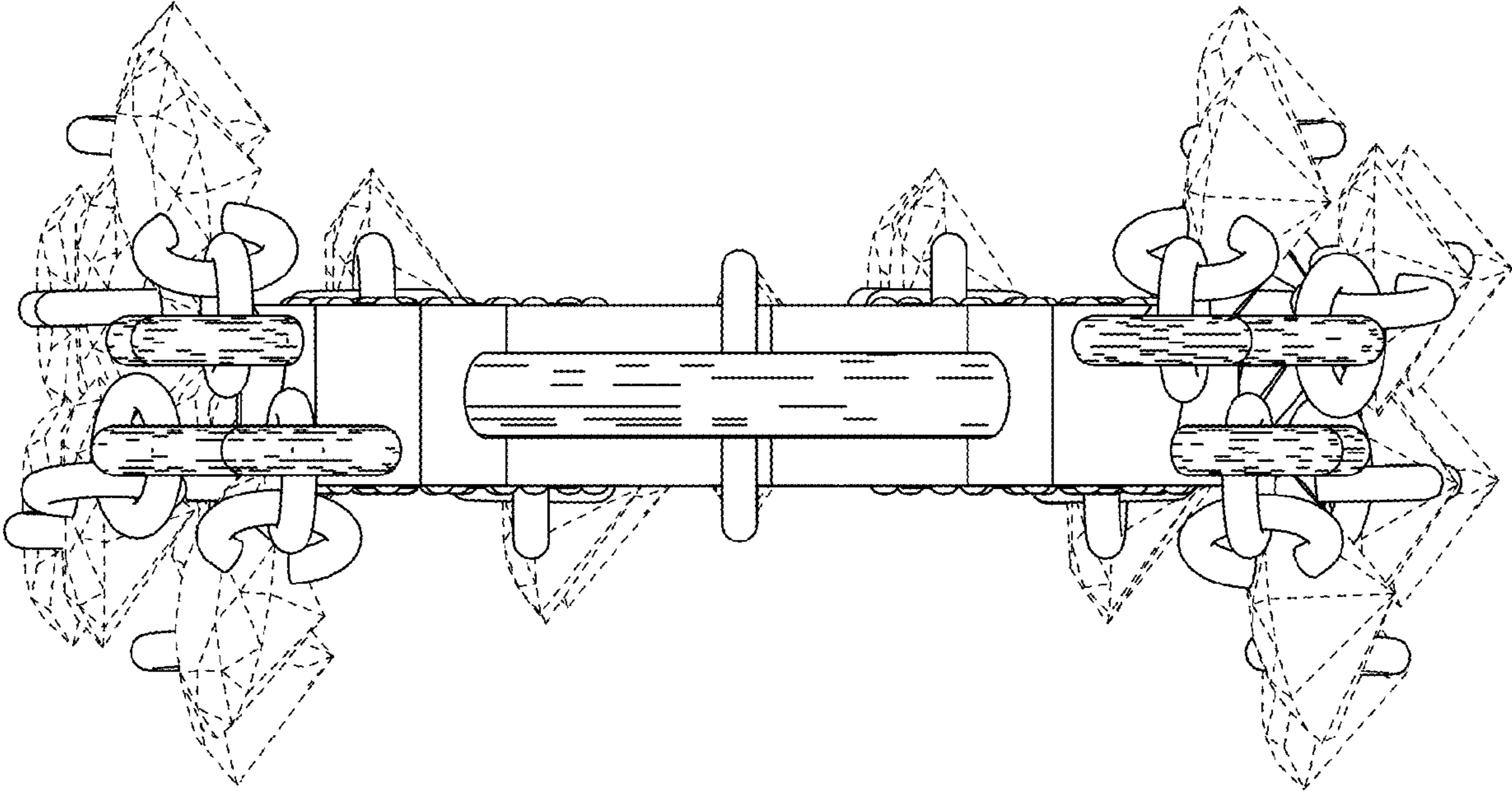

FIG. 7