



US00D878927S

(12) **United States Design Patent** (10) **Patent No.:** **US D878,927 S**
Rawls (45) **Date of Patent:** **** *Mar. 24, 2020**

(54) **CONTAINER**

(71) Applicant: **Roger Rawls**, Chicago, IL (US)

(72) Inventor: **Roger Rawls**, Chicago, IL (US)

(*) Notice: This patent is subject to a terminal disclaimer.

(**) Term: **15 Years**

(21) Appl. No.: **29/663,437**

(22) Filed: **Sep. 14, 2018**

(51) **LOC (12) Cl.** **09-05**

(52) **U.S. Cl.**
USPC **D9/711**

(58) **Field of Classification Search**

USPC D9/702-714, 695-699, 435, 440, 521, D9/454, 544, 723-724, 499, 449, D9/727-728, 442, 447, 504; 222/92, 96, 222/107, 527-529, 215, 491, 206, 222/212-213, 251, 95, 536; 206/438, 206/822, 527; 220/DIG. 7, 669; 215/321, 382, 316, 380; 141/114-115; D28/91.1, 76-78, 82, 88; D24/114; D3/202, 205, 203.2, 270, 271.1-271.4; D7/510, 514-520, 599, 601-602, D7/612-615, 619.2, 628-629
CPC .. B65D 2203/00; B65D 2203/02; B65D 5/00; B65D 5/001; B65D 5/4258; B65D 1/0223; B65D 1/02; B65D 1/10; B65D 1/46; B65D 23/00; B65D 2585/00; B65D 81/60; B65D 81/365; B65D 81/366; B65D 81/368

See application file for complete search history.

(56) **References Cited**

U.S. PATENT DOCUMENTS

D534,812 S * 1/2007 Chadfield D9/723
D692,319 S * 10/2013 Moreau D9/724
D730,746 S * 6/2015 Cywinski D9/711
D827,449 S * 9/2018 Roesler D9/711

* cited by examiner

Primary Examiner — Abraham Bahta

(74) *Attorney, Agent, or Firm* — Brie A. Crawford; Crawford Intellectual Property Law LLC

(57) **CLAIM**

The ornamental design for a container, as shown and described.

DESCRIPTION

FIG. 1 is a front perspective view of the container showing my new design;
FIG. 2 is a front view thereof;
FIG. 3 is a rear view thereof;
FIG. 4 is a top view thereof;
FIG. 5 is a bottom view thereof;
FIG. 6 is a left view thereof; and,
FIG. 7 is a right view thereof.

The container is shown broken away in FIGS. 1, 2, 3, 6, and 7 of the drawings to indicate indeterminate length, it being understood that it has a uniform shape and appearance throughout its length.

1 Claim, 4 Drawing Sheets

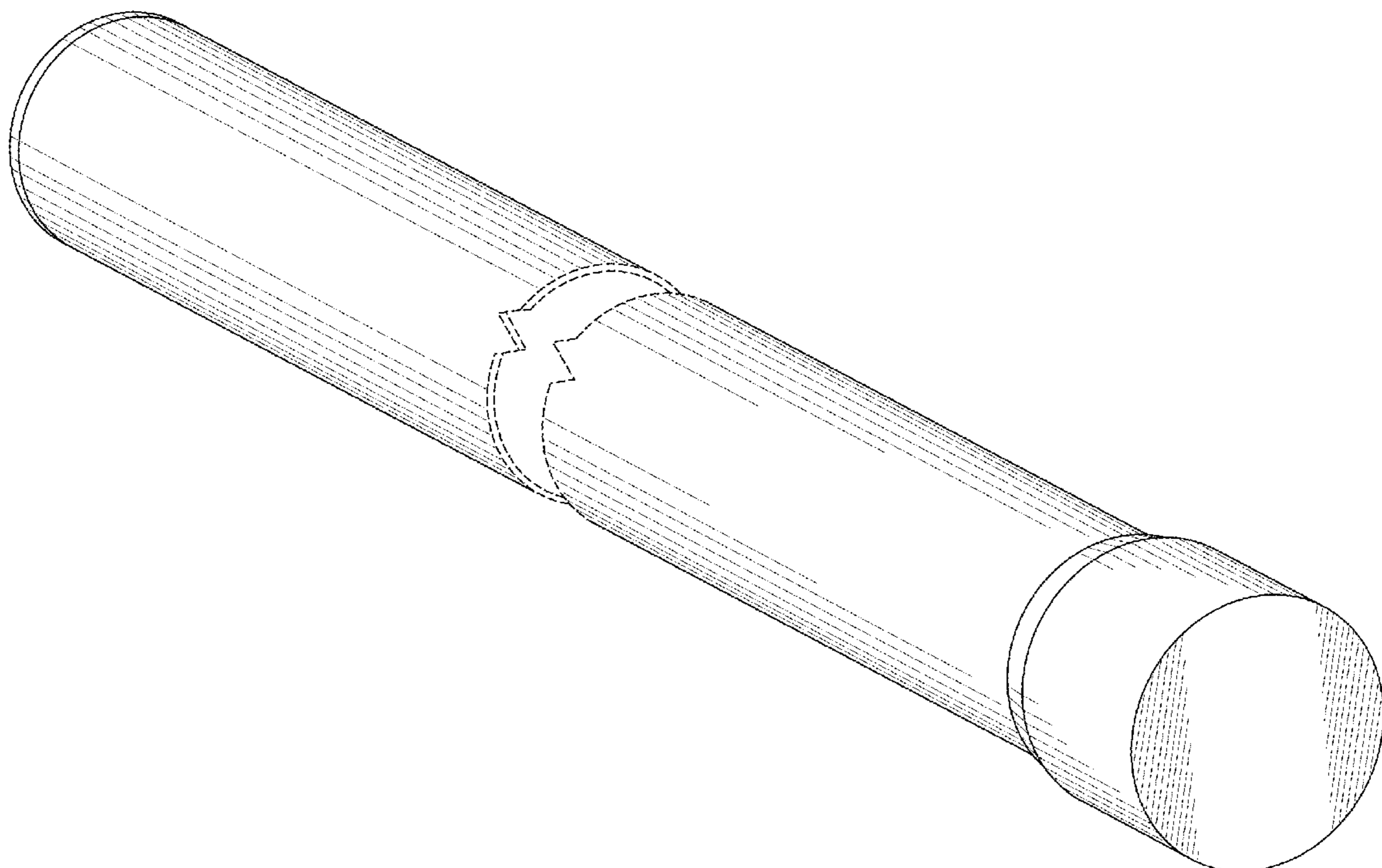

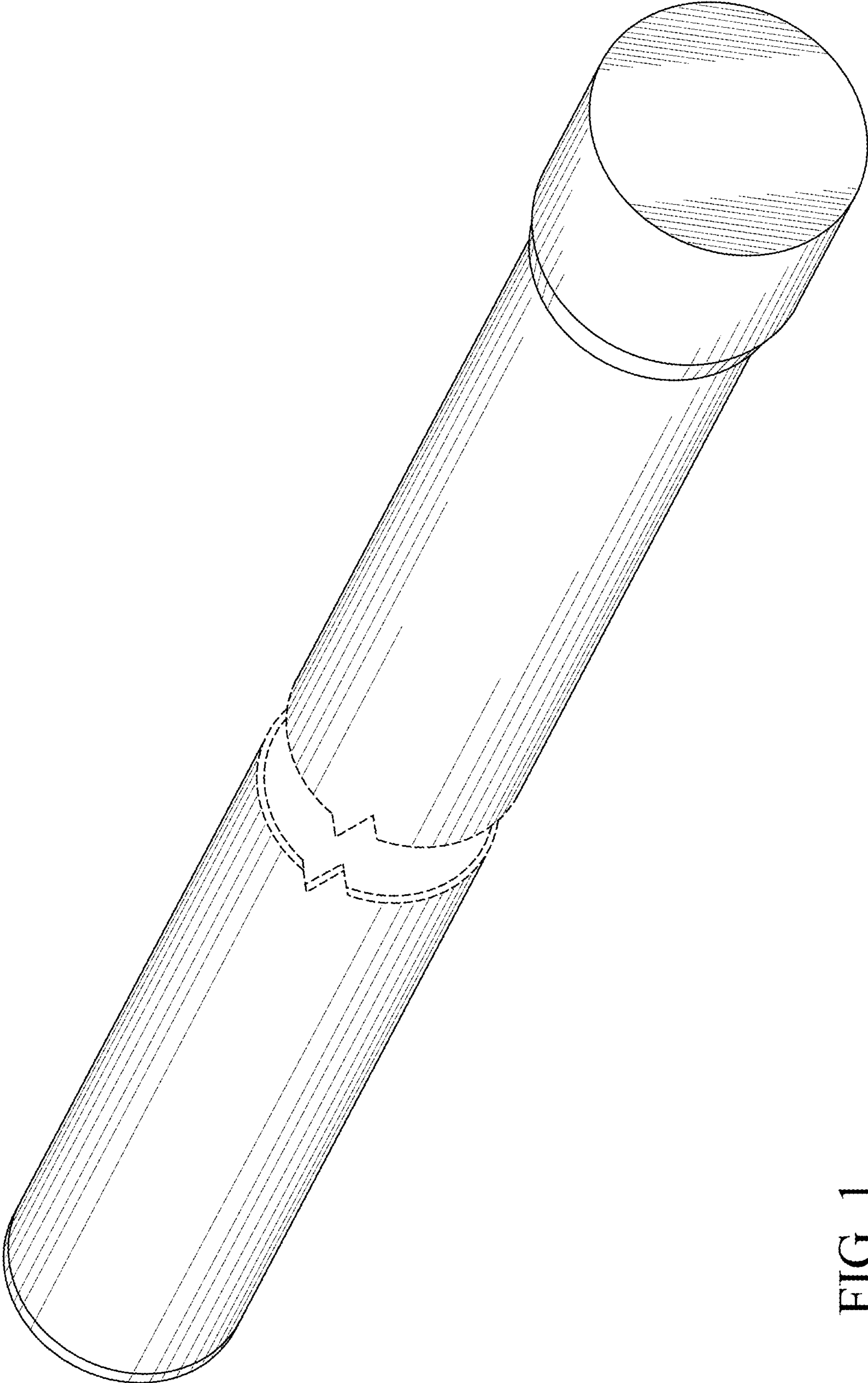

FIG. 1

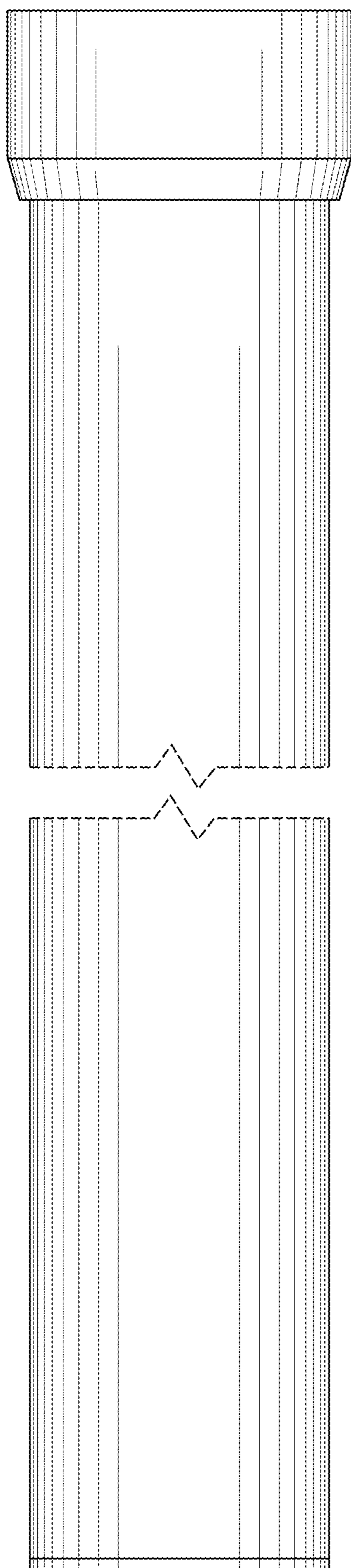

FIG. 2

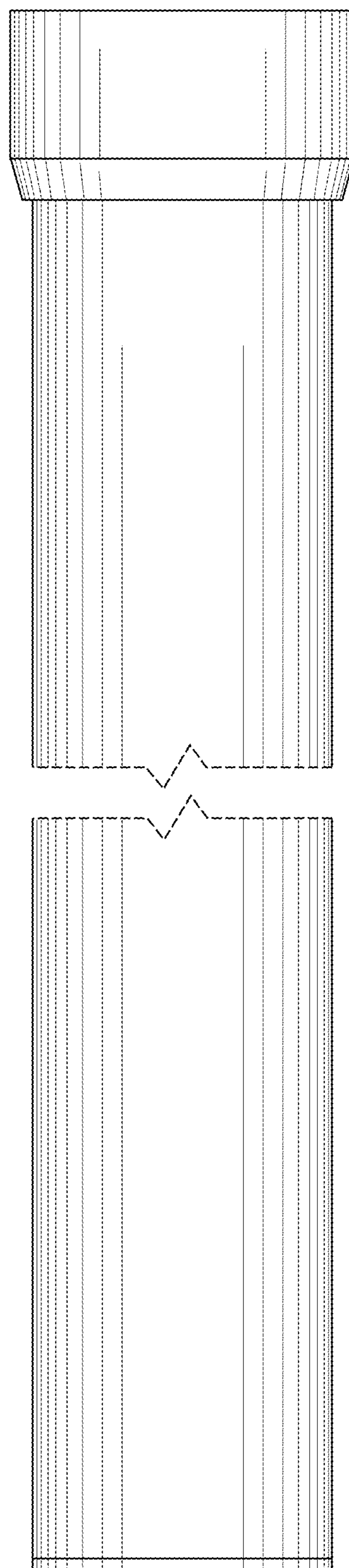

FIG. 3

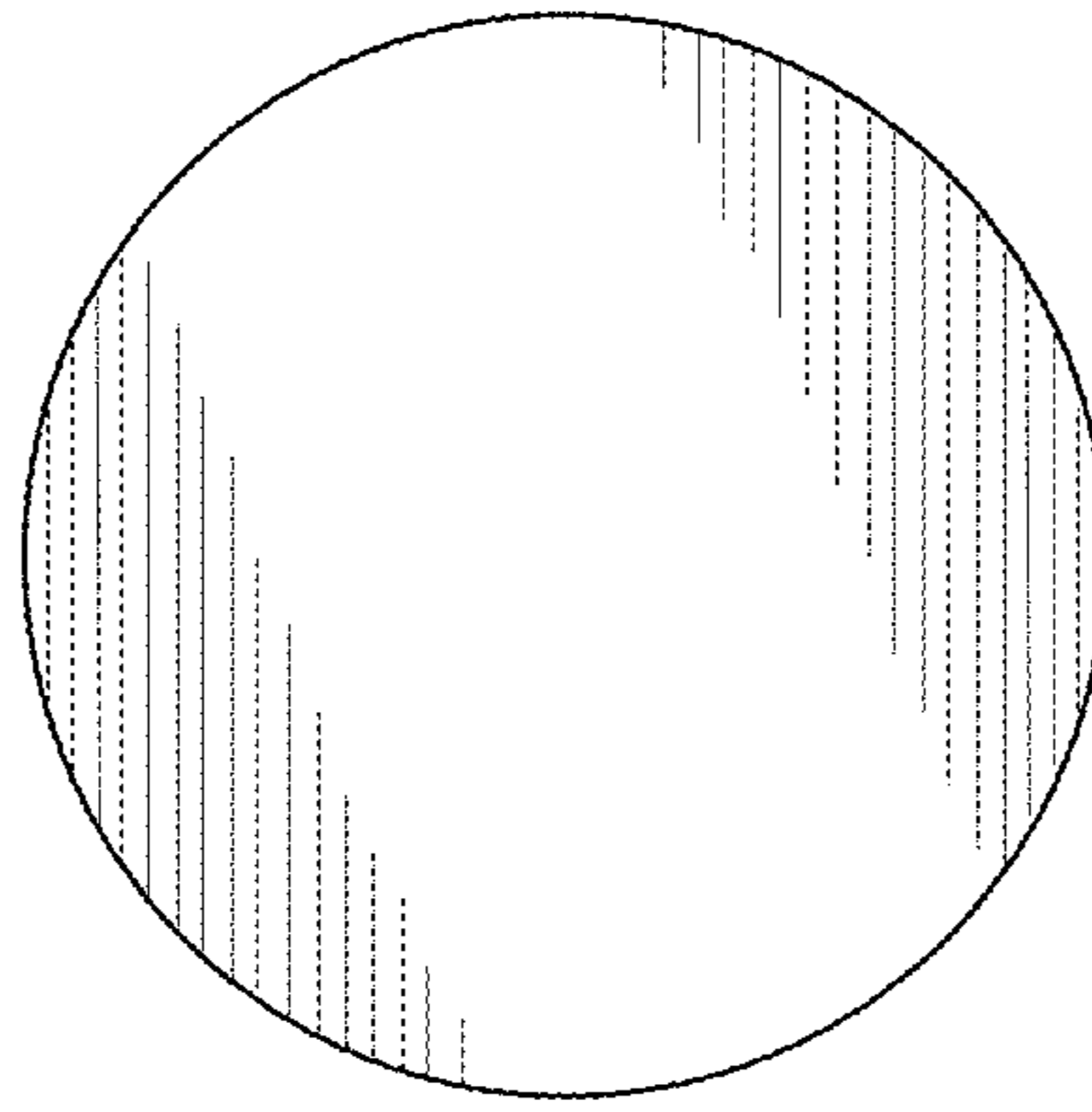

FIG. 4

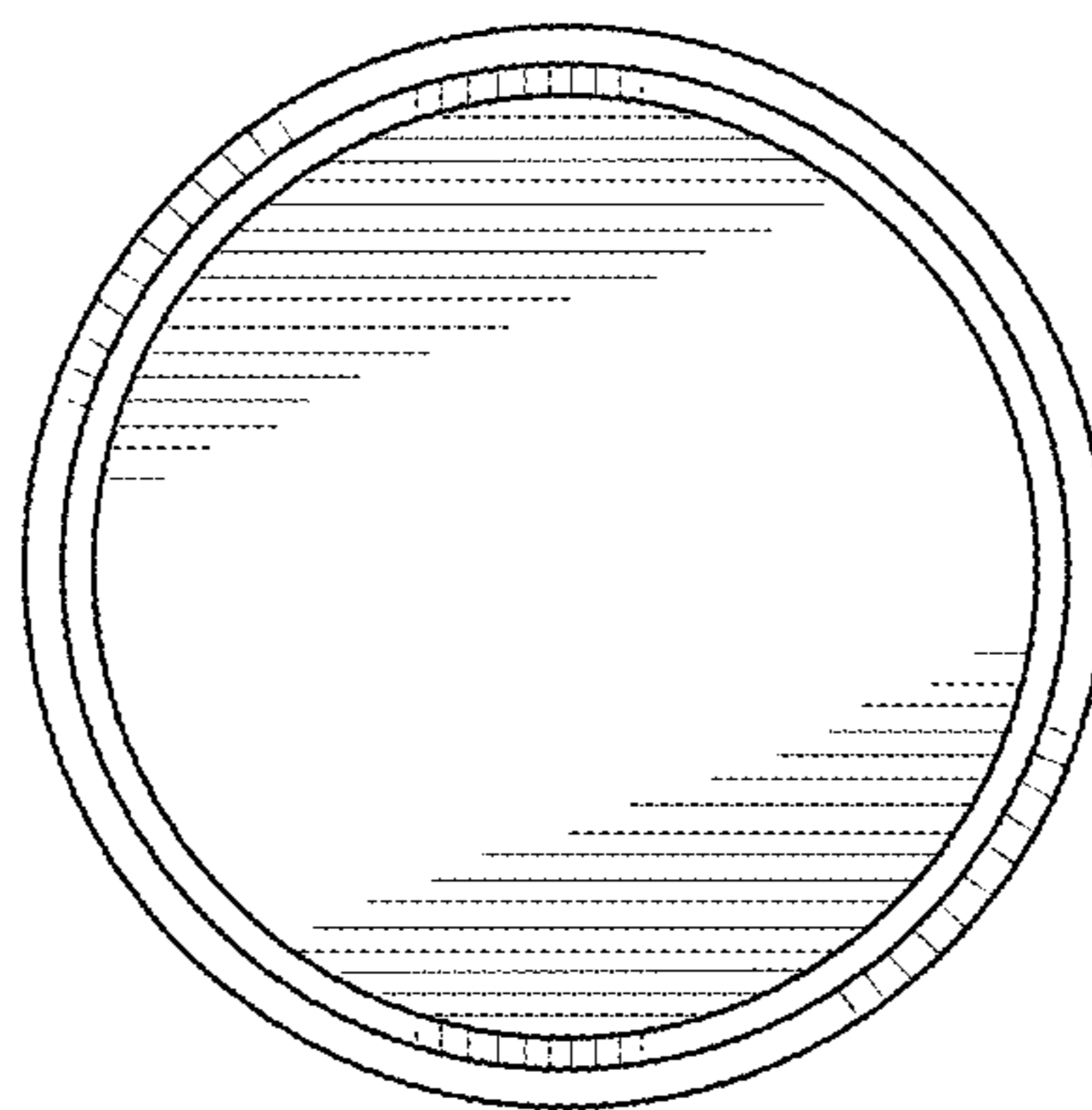

FIG. 5

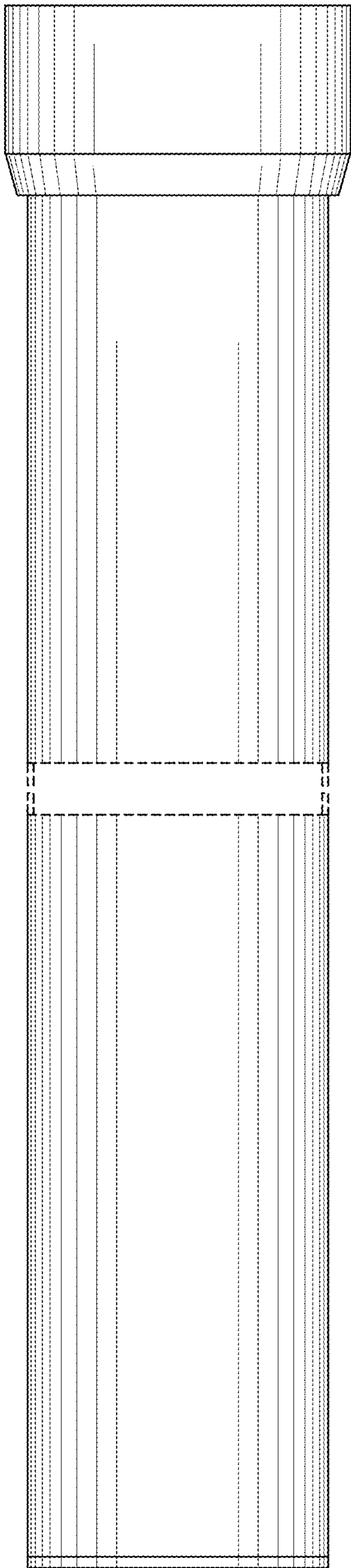

FIG. 6

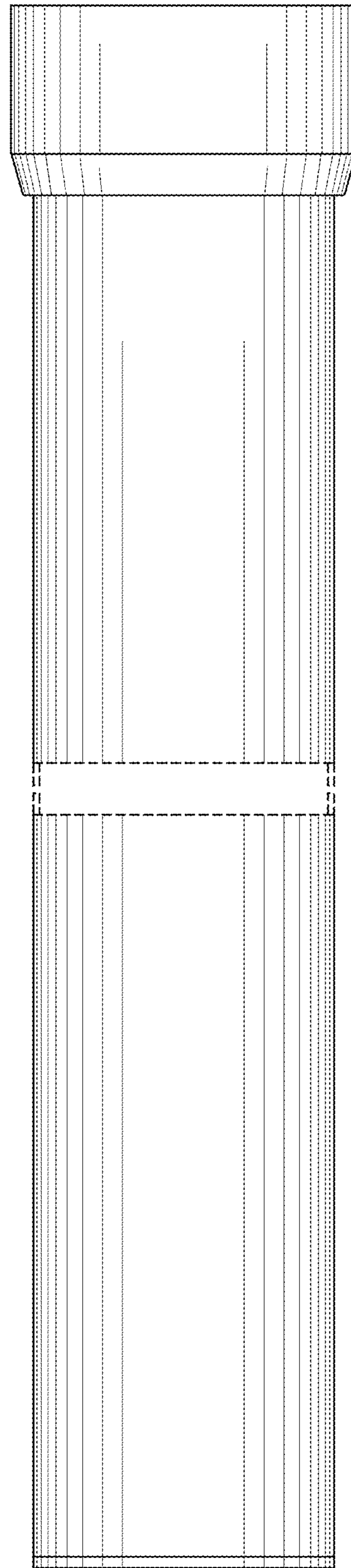

FIG. 7