



US00D878893S

(12) **United States Design Patent**
Kao

(10) **Patent No.:** **US D878,893 S**

(45) **Date of Patent:** **** Mar. 24, 2020**

(54) **CARD-SHAPED MULTI-TOOL**

(71) Applicant: **Wen-Chun Kao**, Taipei (TW)

(72) Inventor: **Wen-Chun Kao**, Taipei (TW)

(**) Term: **15 Years**

(21) Appl. No.: **29/674,693**

(22) Filed: **Dec. 23, 2018**

(51) **LOC (12) Cl.** **08-05**

(52) **U.S. Cl.**
USPC **D8/105**

(58) **Field of Classification Search**
USPC D8/105, 38, 55, 14-19, 21, 53, 100, 103,
D8/26, 34, 87, 99, 356, 28; D3/210
CPC .. B25B 15/008; B25F 1/00; B25F 1/02; B25F
1/04; F16B 45/02
See application file for complete search history.

(56) **References Cited**

U.S. PATENT DOCUMENTS

D552,969 S	*	10/2007	Bobrowski	D8/354
D751,877 S	*	3/2016	Shlaferman	D8/19
D772,678 S	*	11/2016	Haarburger	D8/105
D799,301 S	*	10/2017	Cetera	D8/105

D808,765 S	*	1/2018	Kisling	D8/105
D817,196 S	*	5/2018	Haarburger	D10/64
D824,800 S	*	8/2018	Blume	D11/200
10,206,473 B2	*	2/2019	Haarburger	A45C 13/001
D866,276 S	*	11/2019	Shlaferman	D8/19
2014/0143958 A1	*	5/2014	Barr	B25F 1/00 7/138

* cited by examiner

Primary Examiner — Janice Hallmark

(74) *Attorney, Agent, or Firm* — Raymond Y. Chan;
David and Raymond Patent Firm

(57) **CLAIM**

The ornamental design for a card-shaped multi-tool, as shown and described.

DESCRIPTION

FIG. 1 is a front perspective view of the card-shaped multi-tool of my new design;
FIG. 2 is rear perspective view thereof;
FIG. 3 is a front view thereof;
FIG. 4 is a rear view thereof;
FIG. 5 is a left view thereof;
FIG. 6 is a right view thereof;
FIG. 7 is a top view thereof; and,
FIG. 8 is a bottom view thereof.

1 Claim, 6 Drawing Sheets

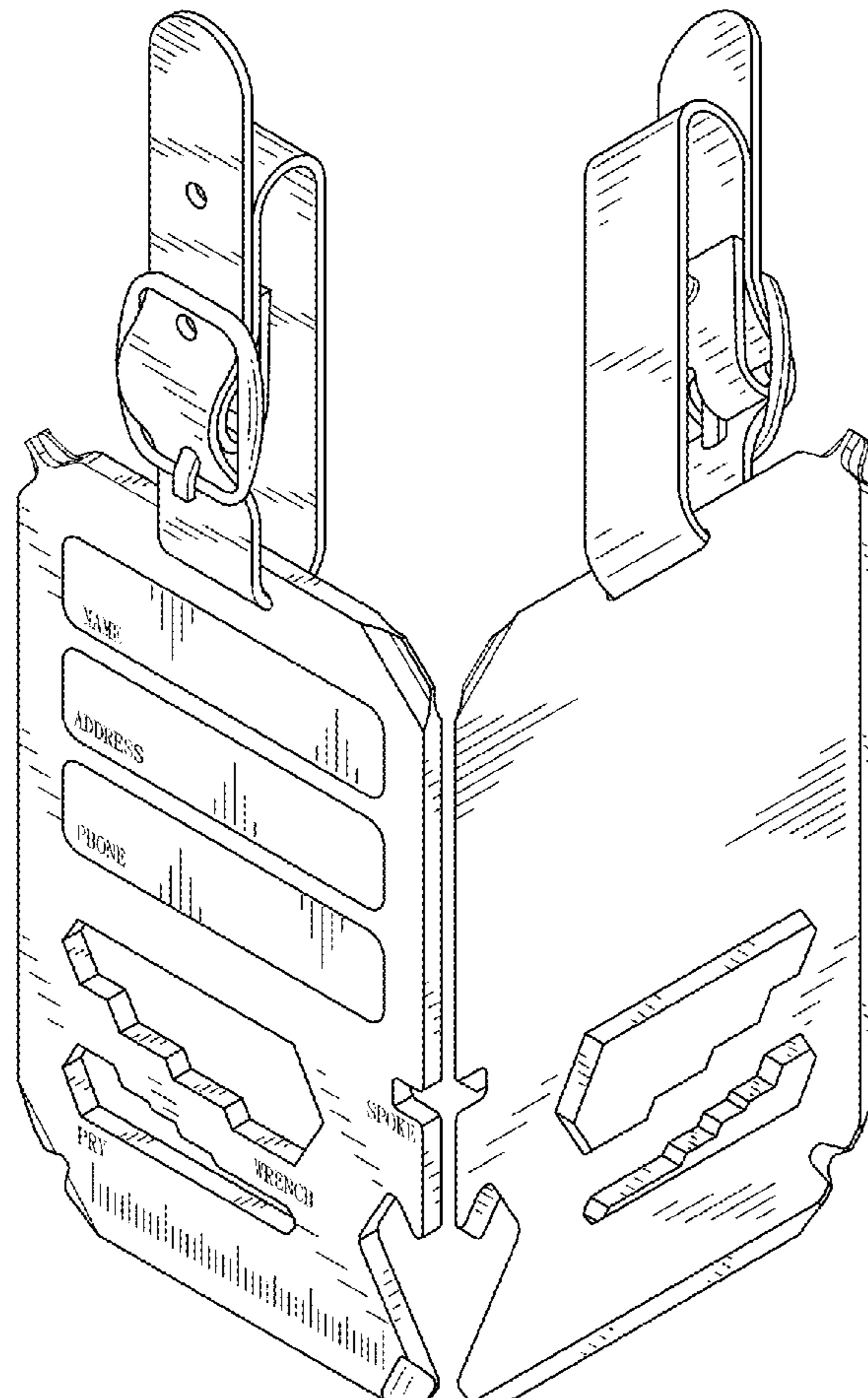

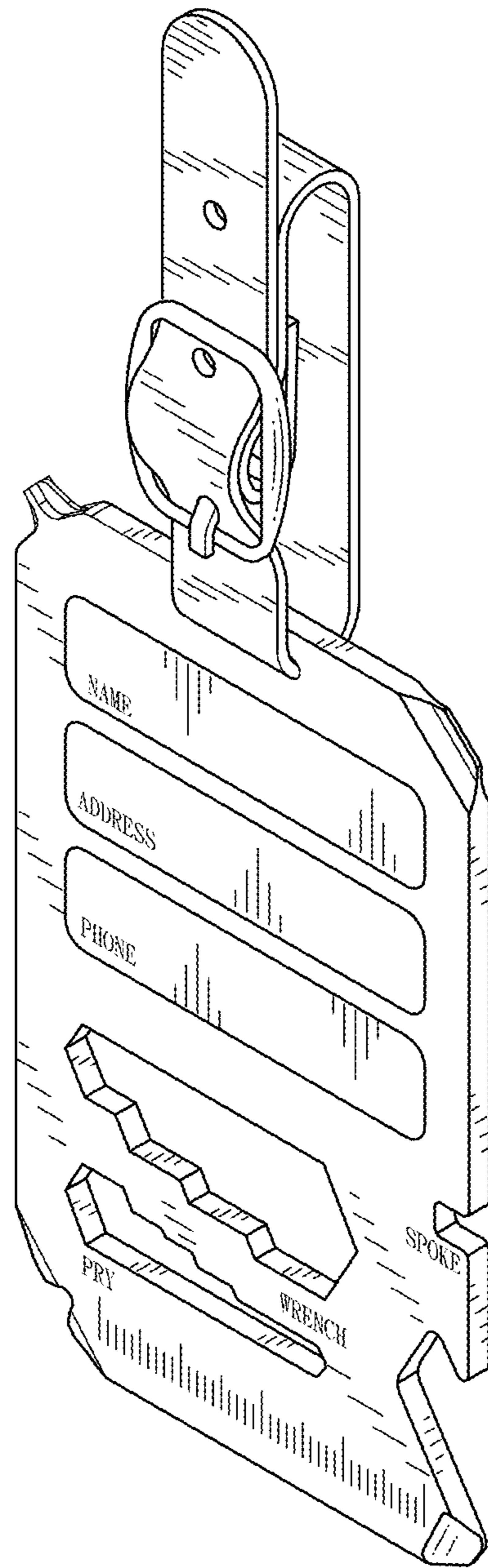

FIG. 1

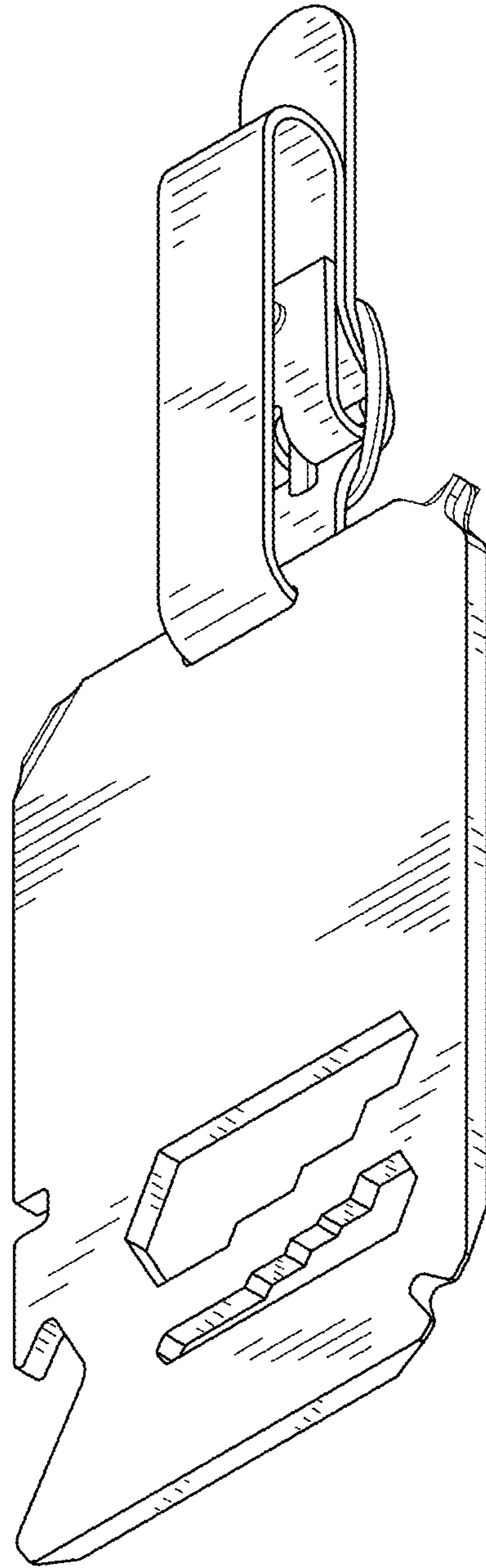

FIG. 2

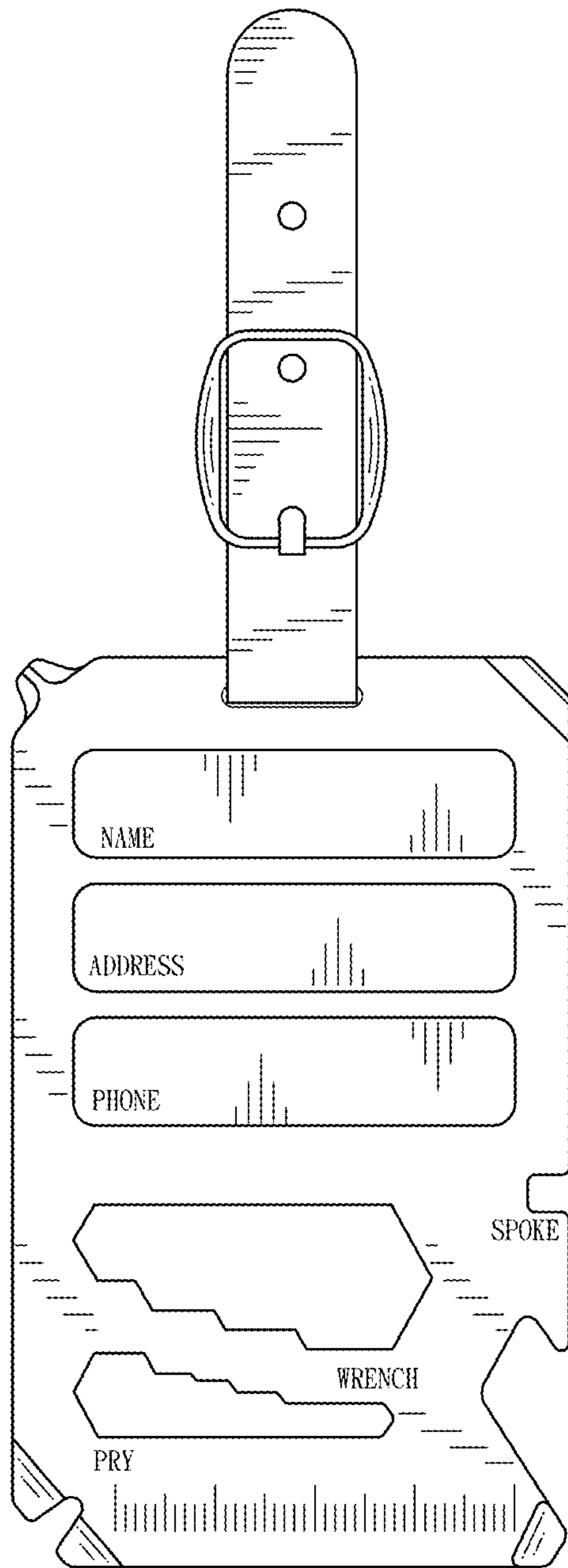

FIG. 3

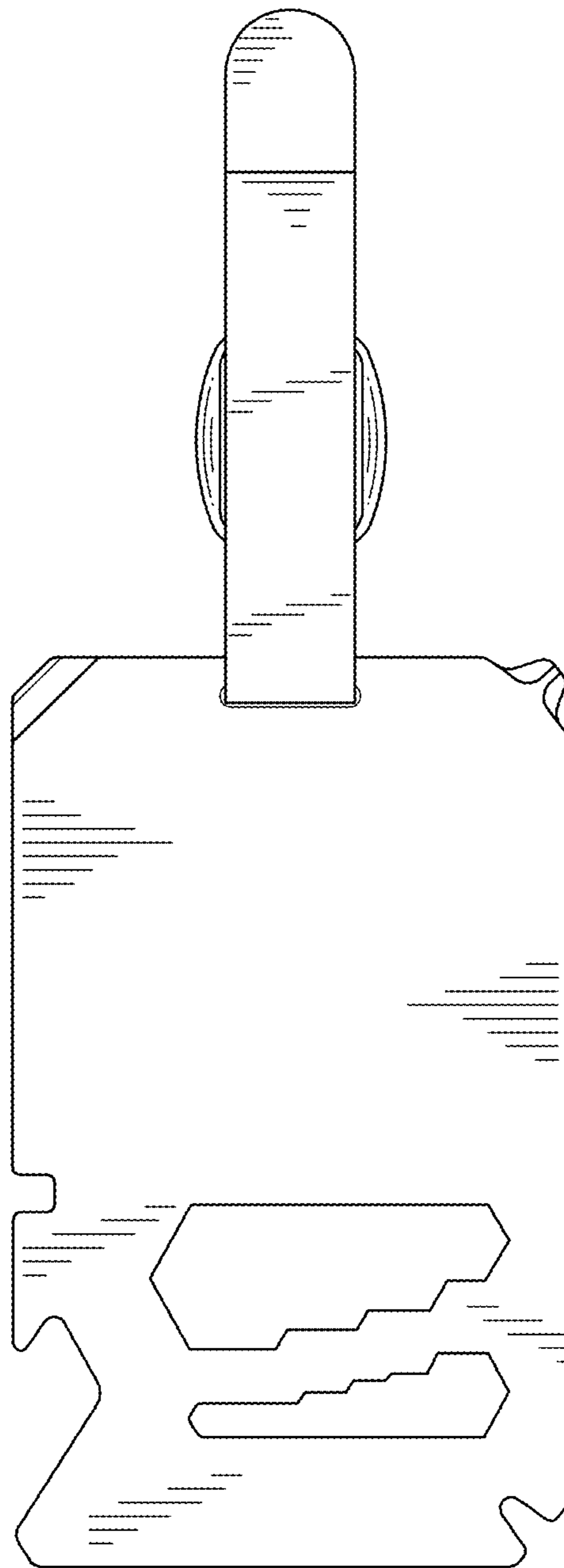

FIG. 4

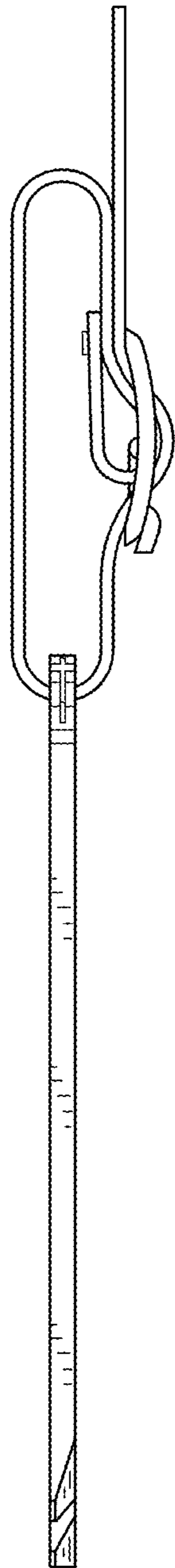

FIG. 5

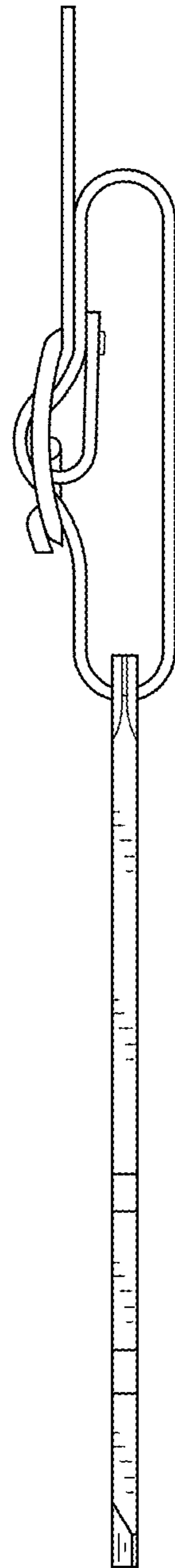

FIG. 6

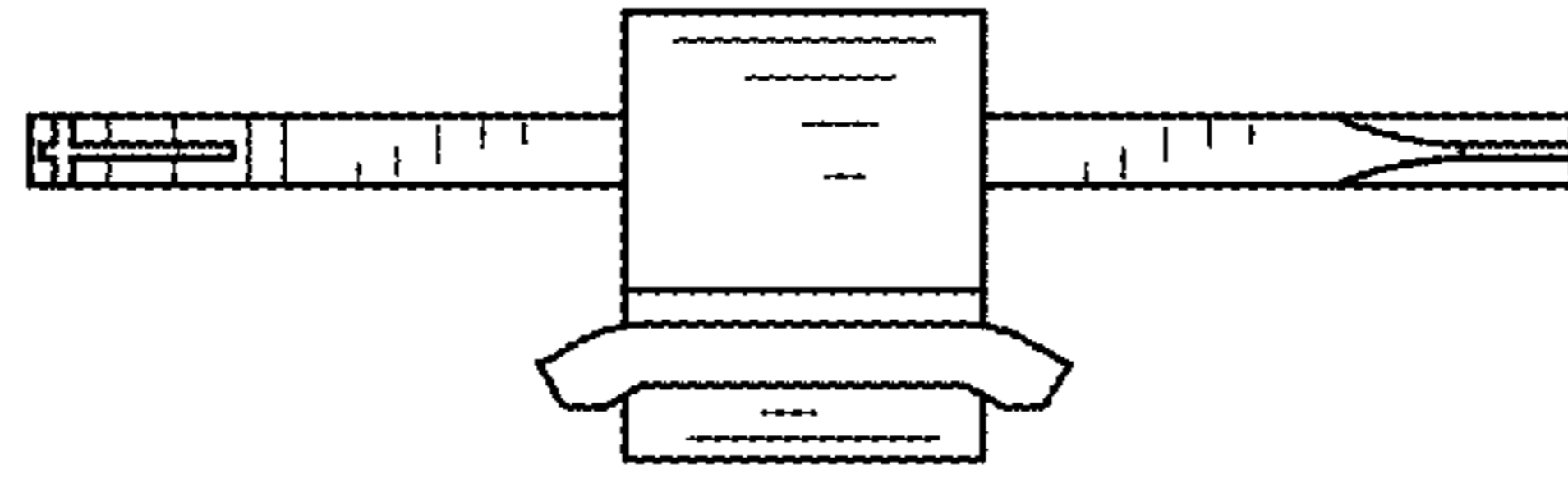

FIG. 7

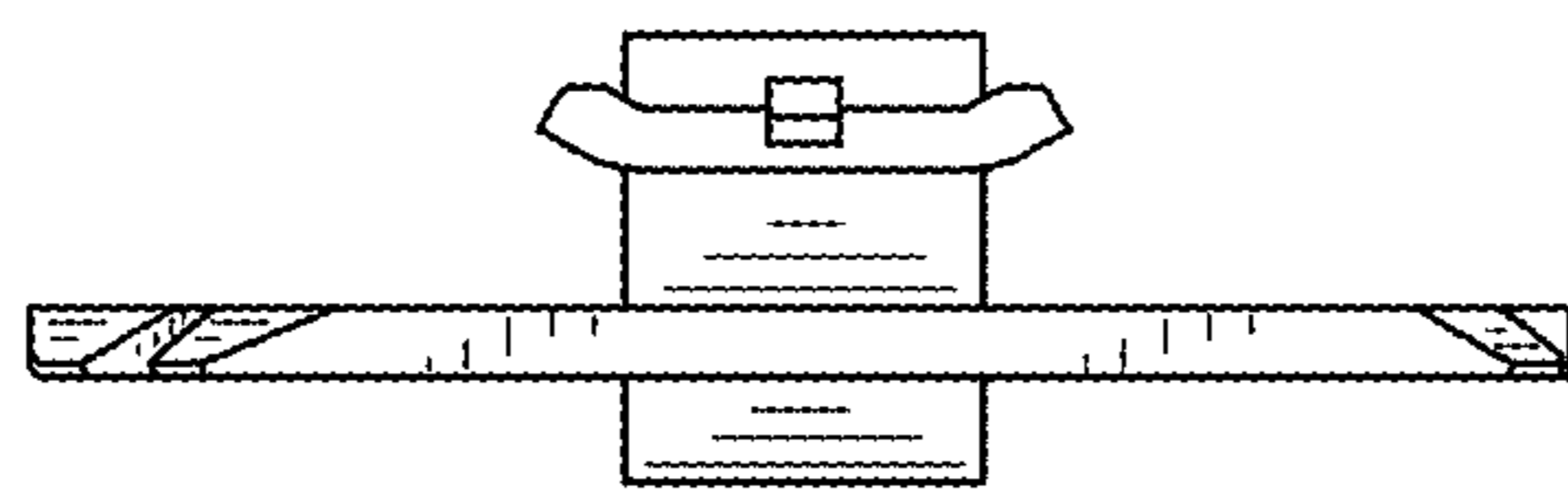

FIG. 8