



US00D878886S

(12) **United States Design Patent**  
**Kosugi et al.**

(10) **Patent No.:** **US D878,886 S**

(45) **Date of Patent:** **\*\* Mar. 24, 2020**

(54) **PORTABLE ELECTRIC SAW**

(71) Applicant: **Koki Holdings Co., Ltd.**, Tokyo (JP)

(72) Inventors: **Shingo Kosugi**, Ibaraki (JP); **Shuji Takeda**, Ibaraki (JP); **Naoki Tadokoro**, Ibaraki (JP)

(73) Assignee: **Koki Holdings Co., Ltd.**, Tokyo (JP)

(\*\*) Term: **15 Years**

(21) Appl. No.: **29/670,284**

(22) Filed: **Nov. 14, 2018**

(30) **Foreign Application Priority Data**

May 17, 2018 (JP) ..... 2018-010782

(51) **LOC (12) Cl.** ..... **08-03**

(52) **U.S. Cl.**  
USPC ..... **D8/64**

(58) **Field of Classification Search**  
USPC .... D8/69, 68, 67, 66, 65, 64, 62, 61; 30/92,  
30/394, 393, 392, 377, 376, 371; 74/50,  
74/49; 173/217, 216; 83/699.21;  
446/145

CPC ..... B26B 7/00; B23D 51/16; B23D 51/10;  
B25F 5/02; B62B 7/00

See application file for complete search history.

(56) **References Cited**

**U.S. PATENT DOCUMENTS**

D440,849 S \* 4/2001 Sakai ..... D8/64  
D456,233 S \* 4/2002 Main ..... D8/64  
D524,131 S \* 7/2006 Chunn ..... D8/64

D524,132 S \* 7/2006 Welsh ..... D8/64  
D525,845 S \* 8/2006 Welsh ..... D8/64  
D526,177 S \* 8/2006 Lui ..... D8/64  
D551,045 S \* 9/2007 Kokawa ..... D8/64  
D560,988 S \* 2/2008 Watson ..... D8/64  
D596,005 S \* 7/2009 Schoch ..... D8/64  
D679,566 S \* 4/2013 Aglassinger ..... D8/64  
D688,928 S \* 9/2013 Busschaert ..... D8/64  
D705,627 S \* 5/2014 Schoch ..... D8/64  
D752,406 S \* 3/2016 Kanda ..... D8/64  
D790,300 S \* 6/2017 Waldron ..... D8/64  
D790,939 S \* 7/2017 Elder ..... D8/64  
D807,135 S \* 1/2018 Naksen ..... D8/64  
D807,136 S \* 1/2018 Naksen ..... D8/64  
D830,146 S \* 10/2018 Croghan ..... D8/64  
D845,730 S \* 4/2019 Takahashi ..... D8/64

\* cited by examiner

*Primary Examiner* — Austin Murphy

(74) *Attorney, Agent, or Firm* — JCIPRNET

(57) **CLAIM**

The ornamental design for a portable electric saw, as shown and described.

**DESCRIPTION**

FIG. 1 is a perspective view of a portable electric saw showing our new design;  
FIG. 2 is a front view thereof;  
FIG. 3 is a rear view thereof;  
FIG. 4 is a left side view thereof;  
FIG. 5 is a right side view thereof;  
FIG. 6 is a top view thereof; and,  
FIG. 7 is a bottom view thereof.

The broken lines illustrate portions of the portable electric saw that form no part of the claimed design.

**1 Claim, 5 Drawing Sheets**

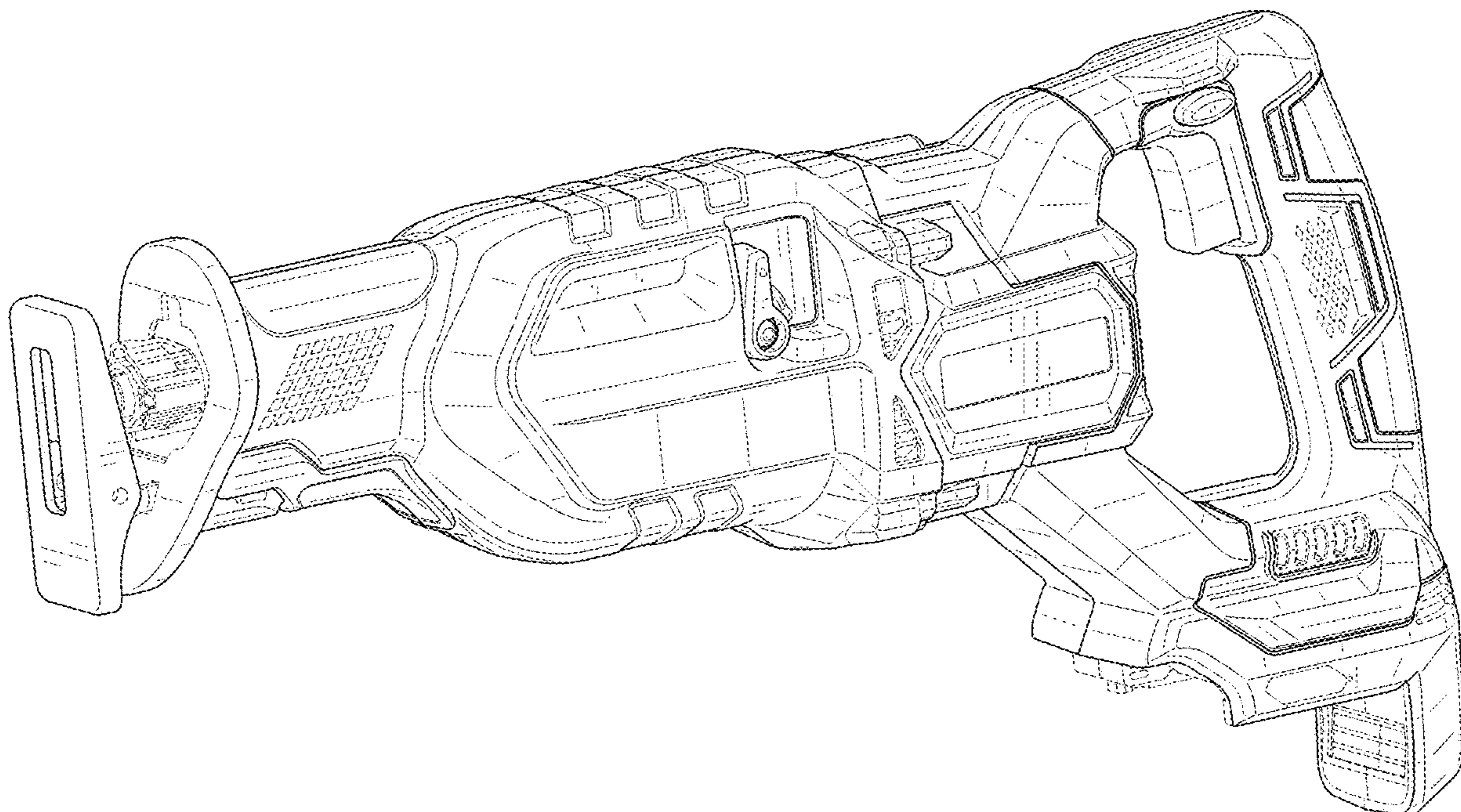

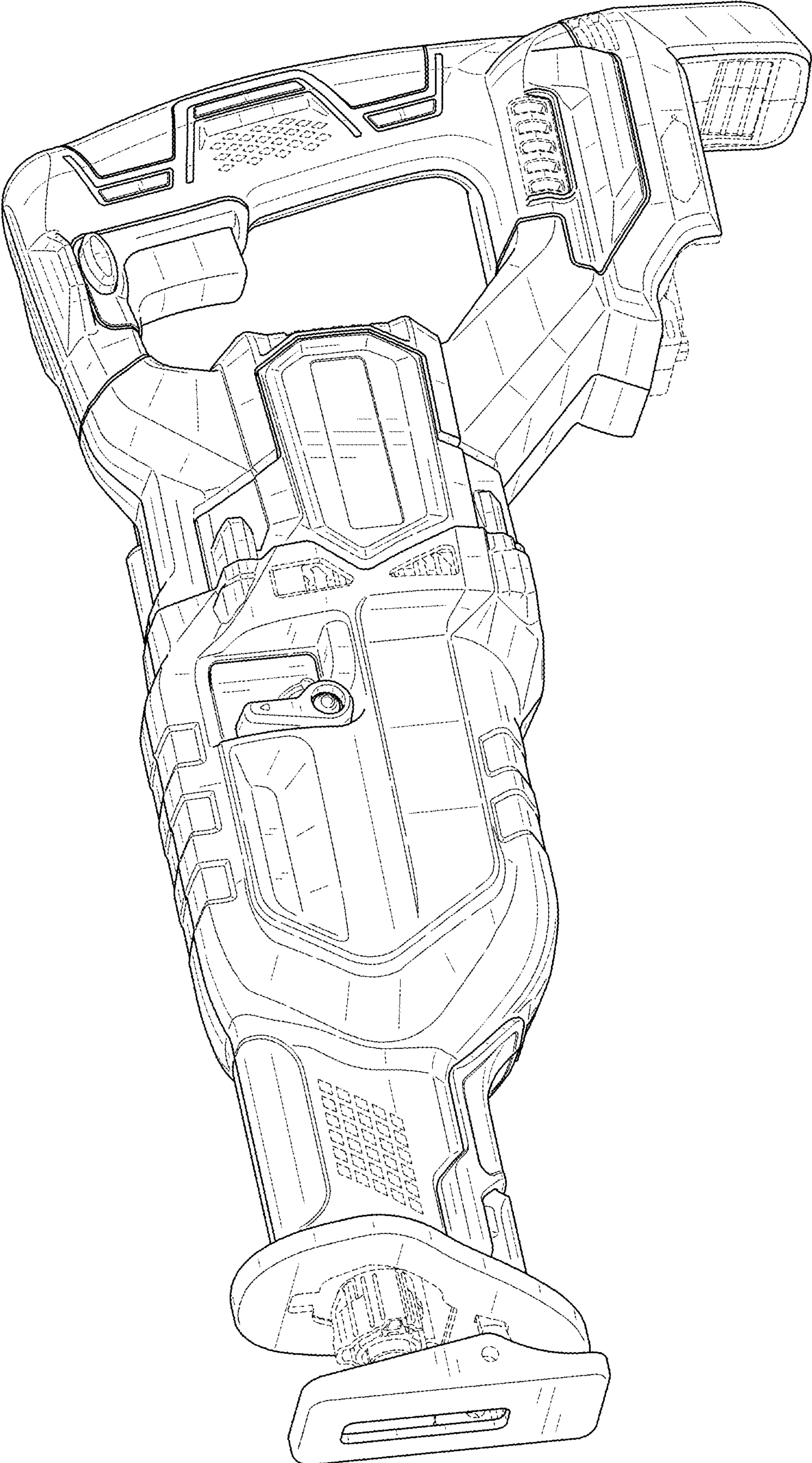

FIG. 1

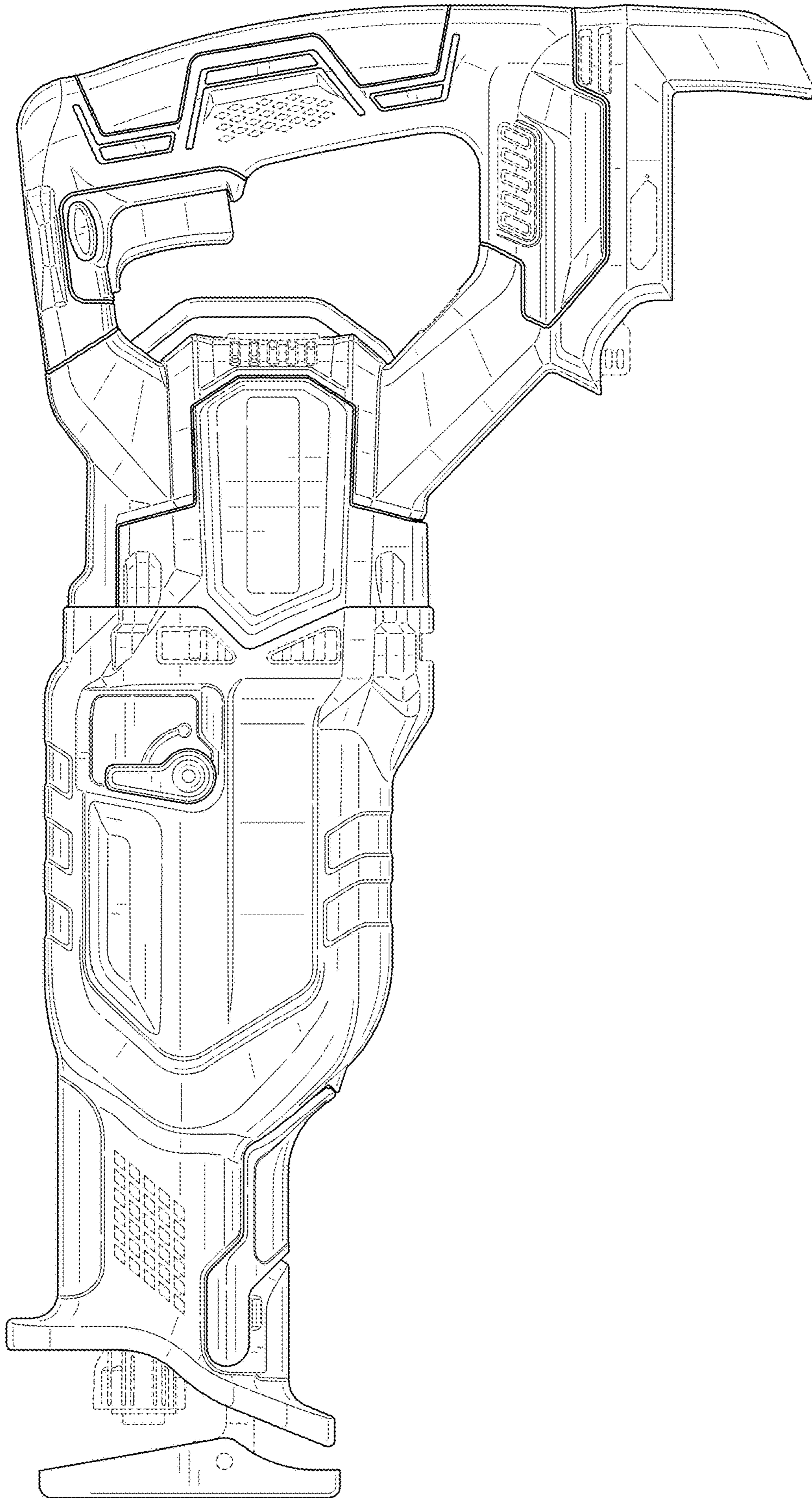

FIG. 2

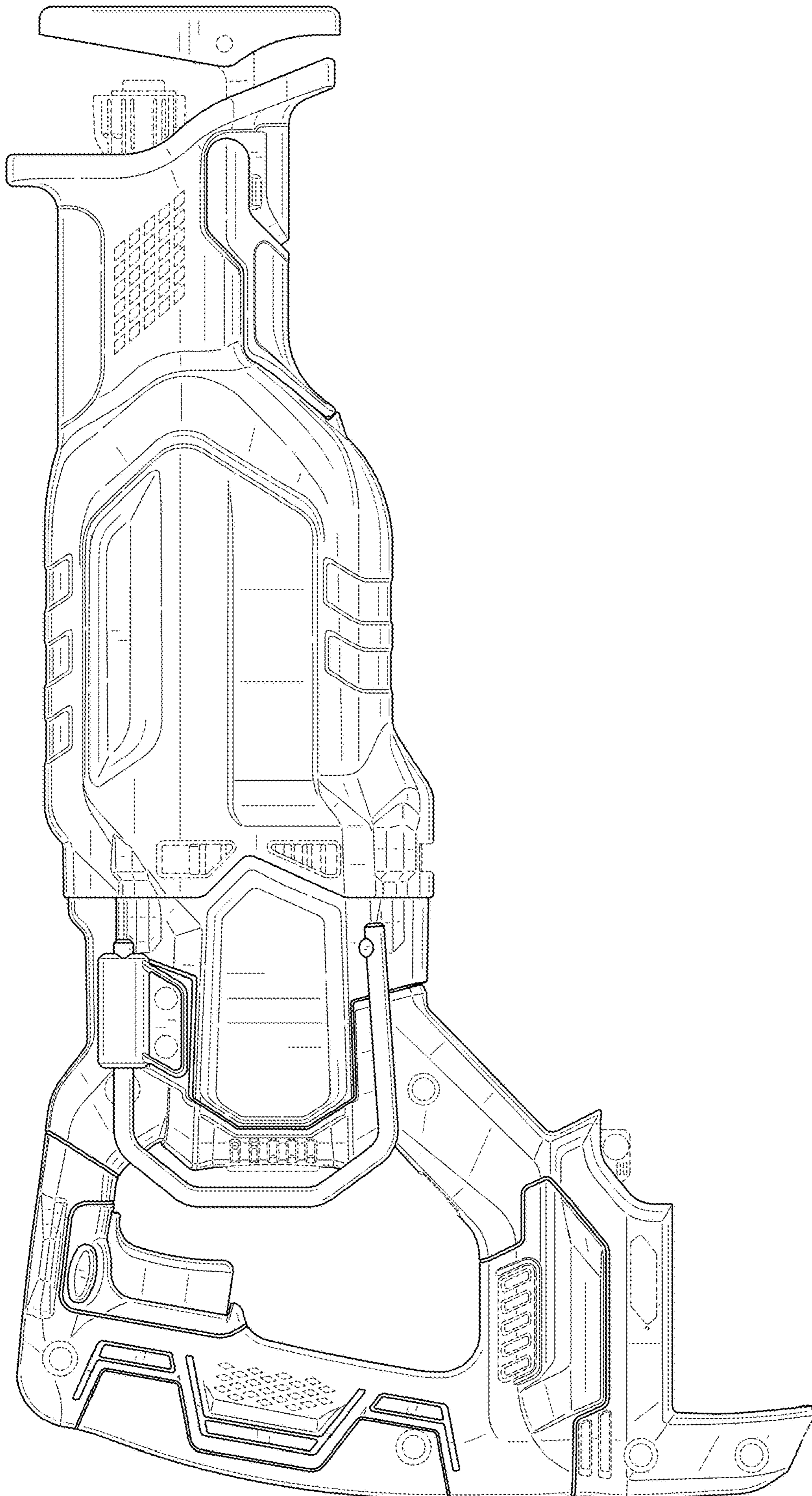

FIG. 3

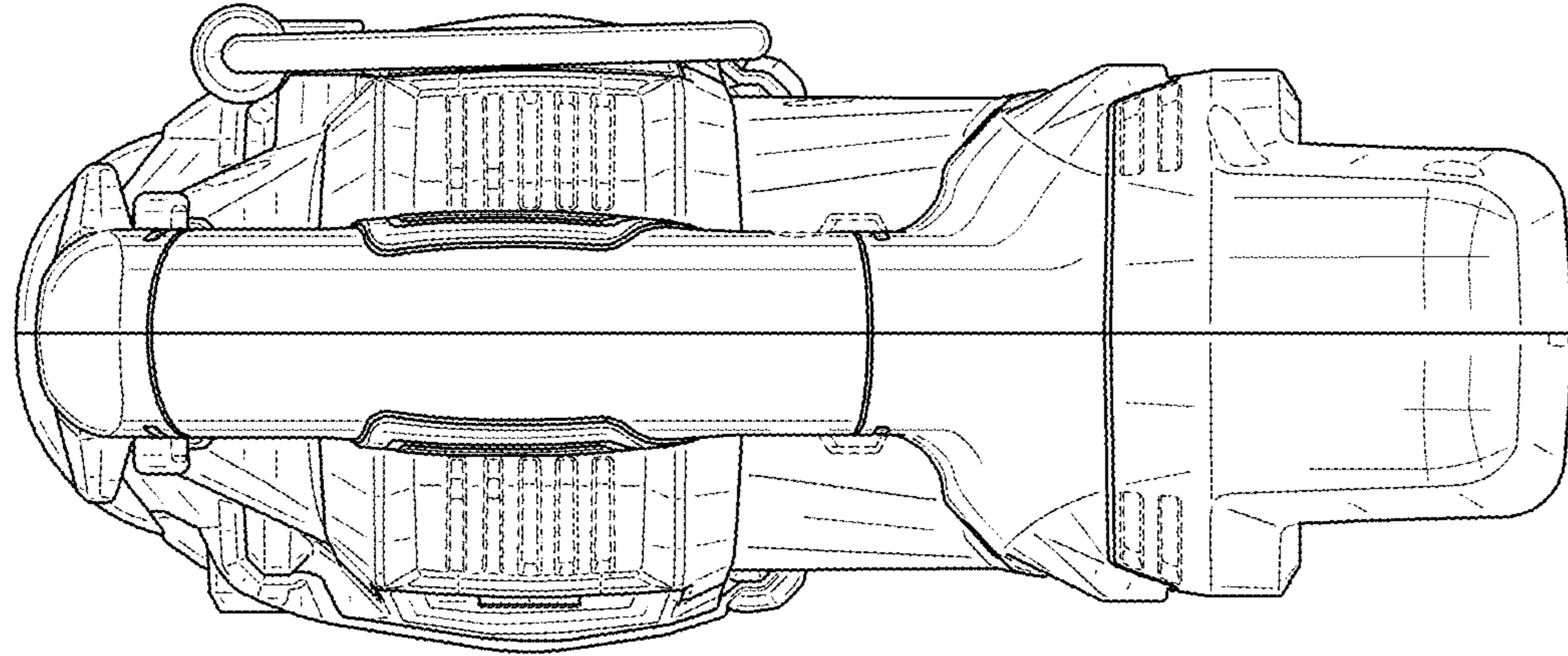

FIG. 5

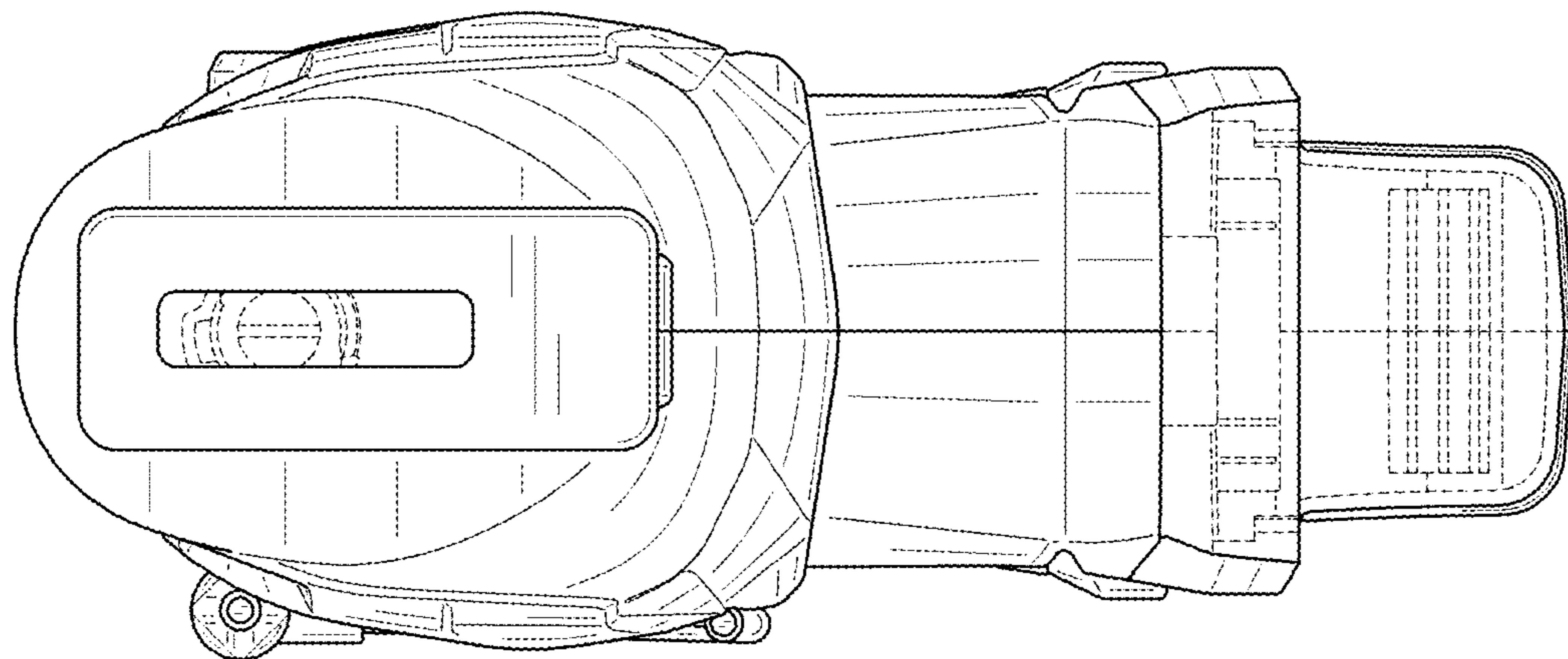

FIG. 4

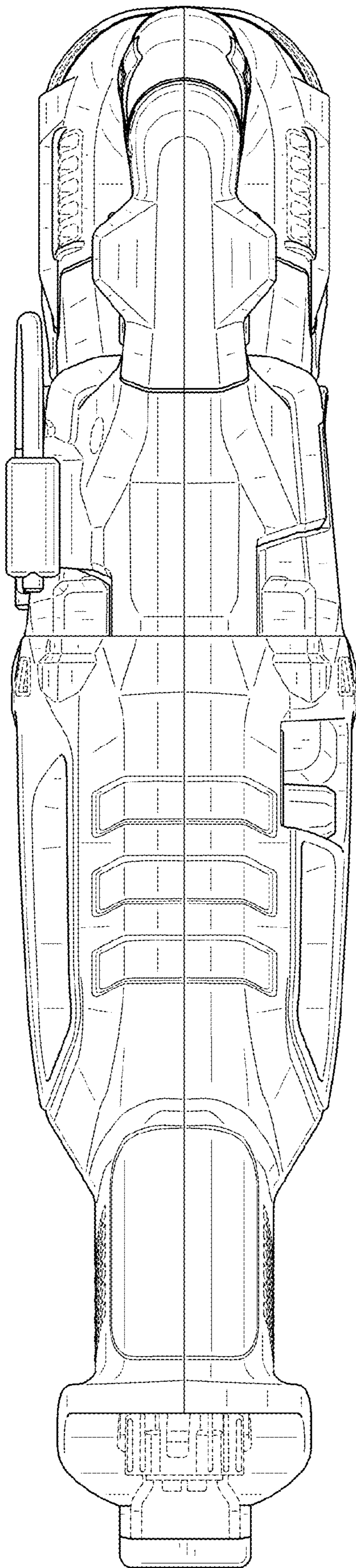

FIG. 6

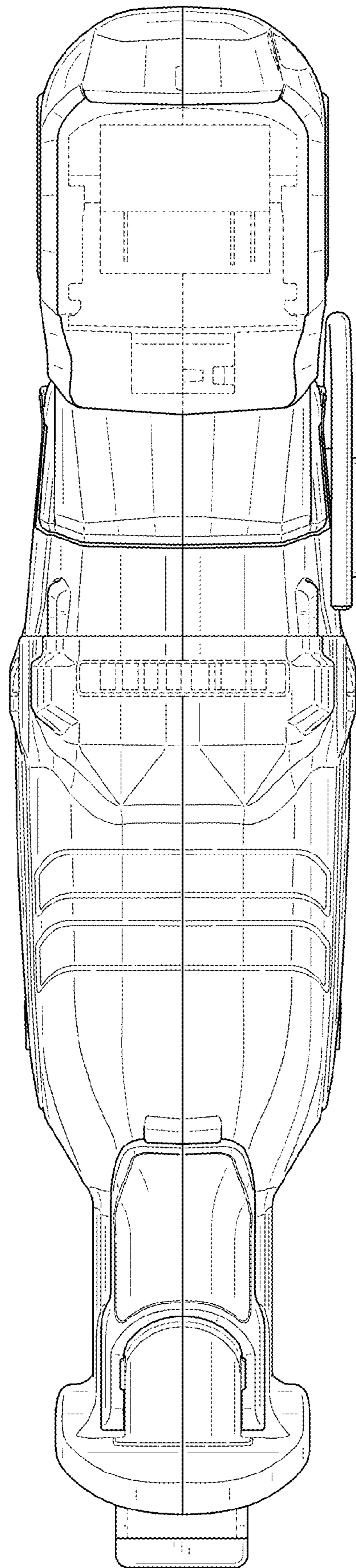

FIG. 7