



US00D878880S

(12) **United States Design Patent**
Roberts et al.

(10) **Patent No.:** **US D878,880 S**
(45) **Date of Patent:** **** Mar. 24, 2020**

- (54) **TOOL**
- (71) Applicant: **Fiskars Brands, Inc.**, Middleton, WI (US)
- (72) Inventors: **Colin Roberts**, Waunakee, WI (US);
Emery Weber, Madison, WI (US);
Stephen Dechant, Waunakee, WI (US);
James Meiller, Fitchburg, WI (US)
- (73) Assignee: **FISKARS FINLAND OY AB**, Helsinki (FI)
- (**) Term: **15 Years**
- (21) Appl. No.: **29/639,339**
- (22) Filed: **Mar. 6, 2018**
- (51) **LOC (12) Cl.** **08-01**
- (52) **U.S. Cl.**
USPC **D8/5**
- (58) **Field of Classification Search**
USPC D8/4, 5, 6, 7, 9, 12, 95
CPC A01G 3/02; A01G 3/0251; A01G 3/04;
A01G 3/06; B23D 51/10
See application file for complete search history.

- D414,670 S * 10/1999 Linden D8/95
- D513,956 S * 1/2006 Tran D8/95
- 7,065,885 B1 * 6/2006 Chen B23D 51/10
30/331
- D664,823 S * 8/2012 Pringnitz D8/7
- D684,031 S 6/2013 Block
- D705,024 S 5/2014 Masalin et al.
- D706,593 S 6/2014 Meiller et al.
- D741,415 S 10/2015 Masalin et al.
- 9,656,397 B2 5/2017 Huhtala et al.
- D795,669 S 8/2017 Sokka et al.
- D801,147 S 10/2017 Sokka et al.

* cited by examiner

Primary Examiner — Sheryl Lane

(74) *Attorney, Agent, or Firm* — Leason Ellis LLP

(57) **CLAIM**

The ornamental design for a tool, as shown and described.

DESCRIPTION

FIG. 1 is a top perspective view of the claimed design;
FIG. 2 is front view thereof;
FIG. 3 is a rear view thereof;
FIG. 4 is a left side view thereof;
FIG. 5 is a right side view thereof;
FIG. 6 is a top view thereof; and,
FIG. 7 is a bottom view thereof.

The broken lines represent portions of the tool and form no part of the claimed design.

1 Claim, 6 Drawing Sheets

- (56) **References Cited**
U.S. PATENT DOCUMENTS
D346,937 S * 5/1994 Backman D8/7
D357,166 S 4/1995 Concari

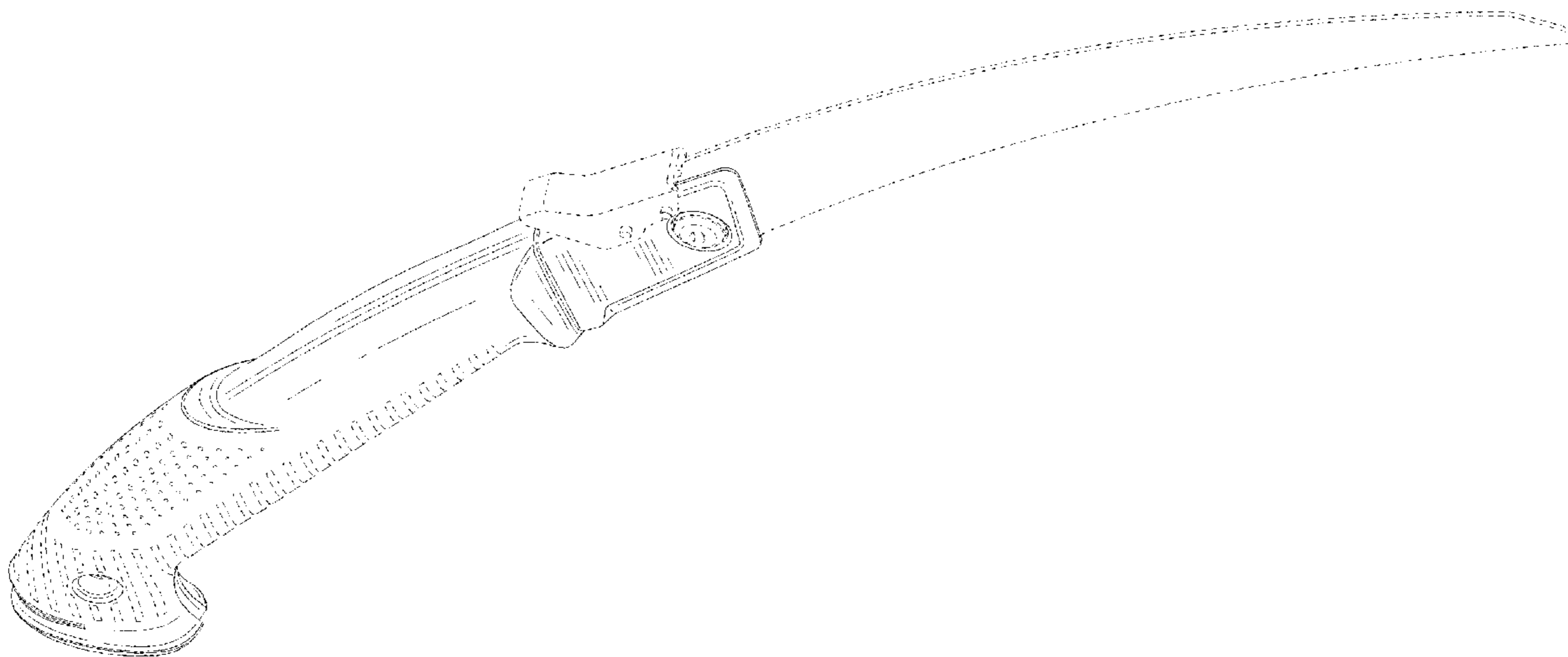

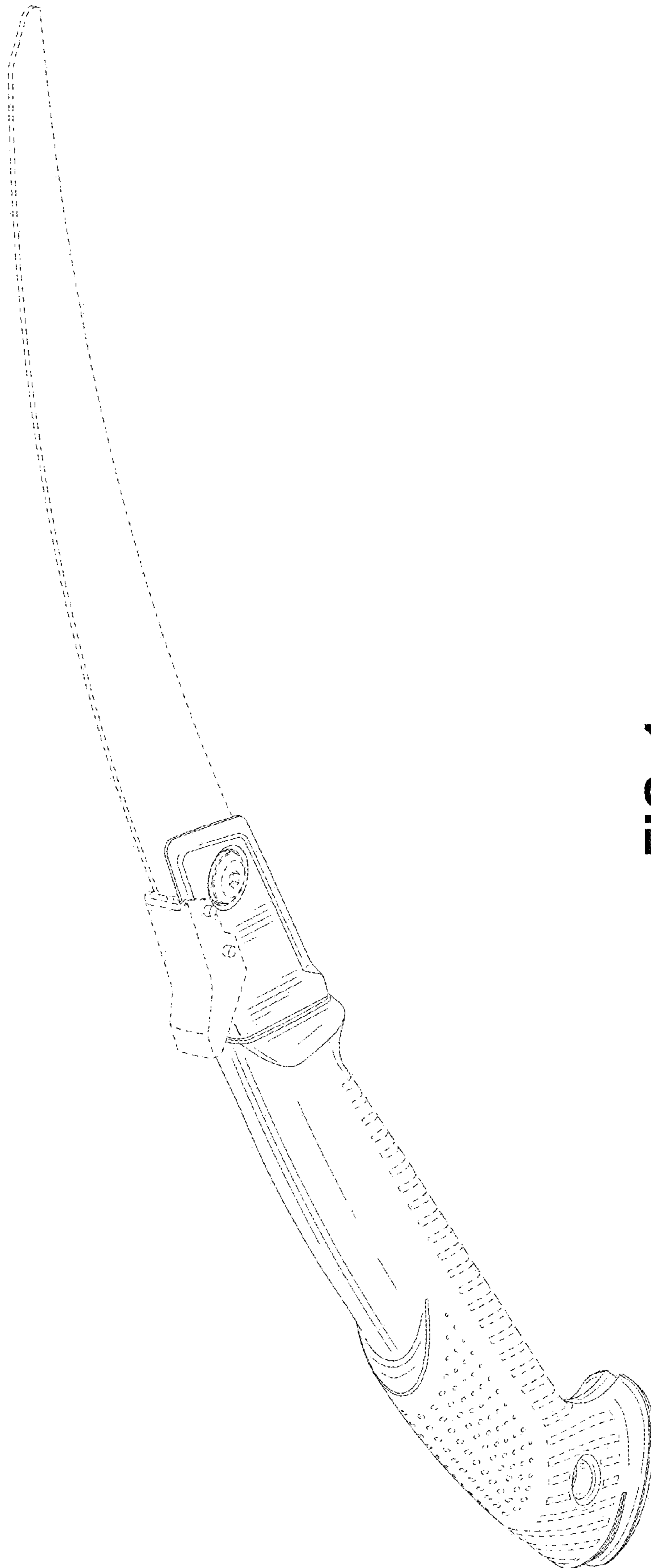

FIG. 1

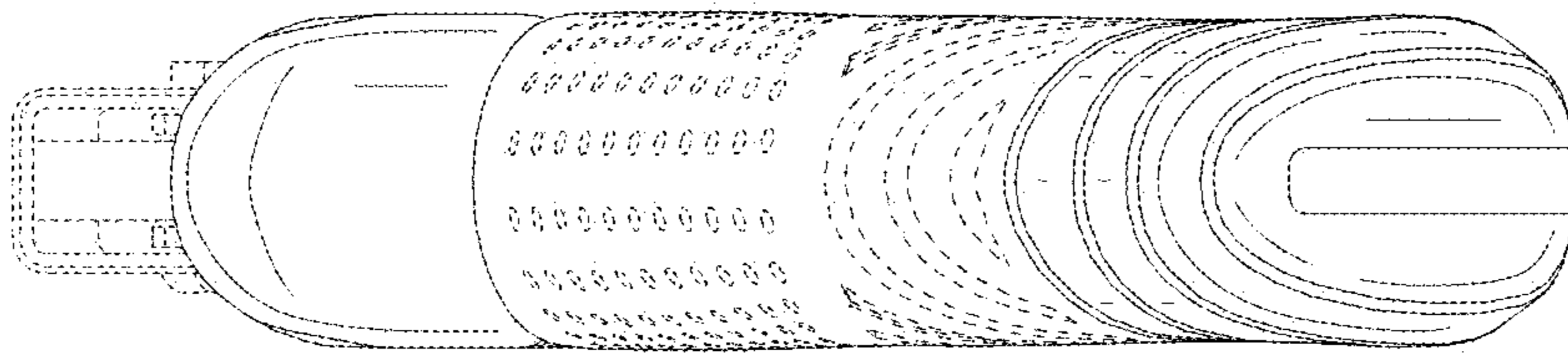

FIG. 3

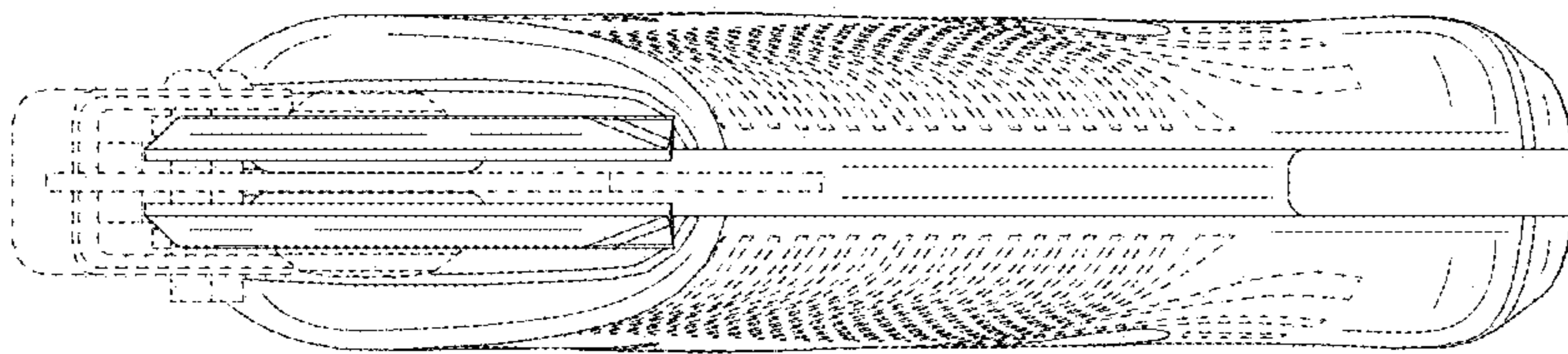

FIG. 2

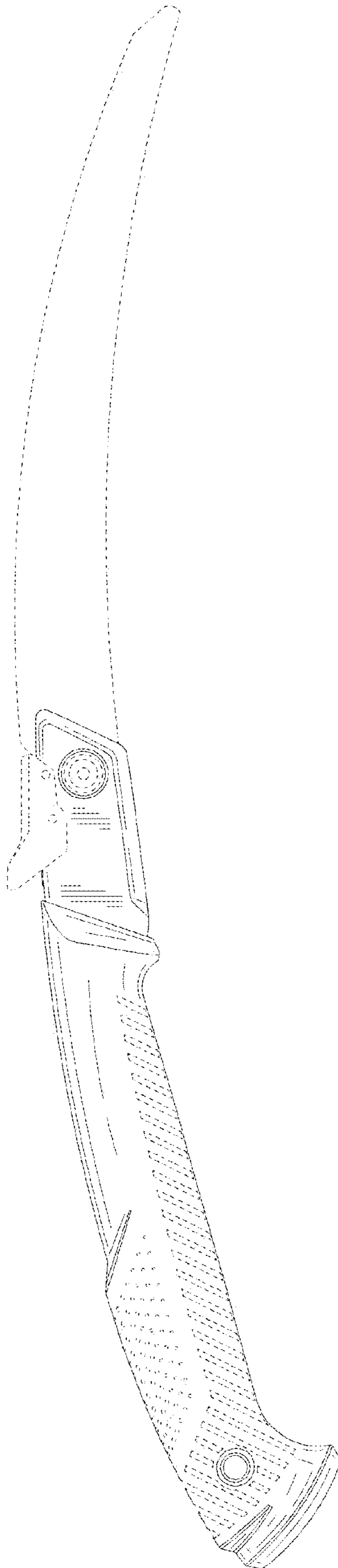

FIG. 4

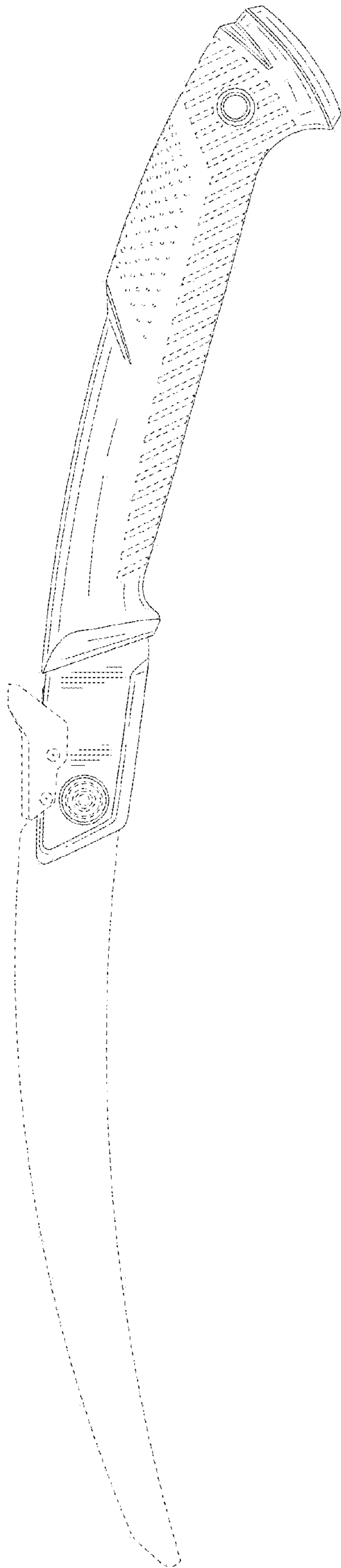

FIG. 5

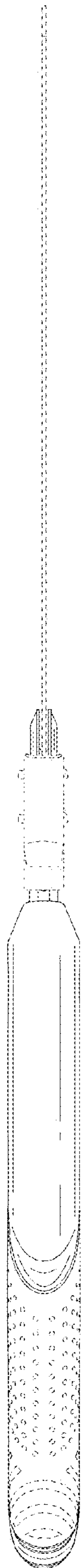

FIG. 6

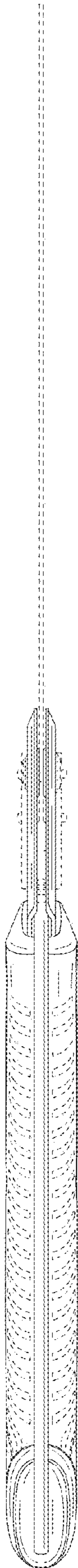

FIG. 7