



US00D878863S

(12) **United States Design Patent**  
**Ke**

(10) **Patent No.:** **US D878,863 S**  
(45) **Date of Patent:** **\*\* Mar. 24, 2020**

(54) **WATER BOTTLE**

**DESCRIPTION**

- (71) Applicant: **Seikilife (Shanghai) Housewares Co., Ltd.**, Shanghai (CN)
- (72) Inventor: **David Ke**, Shanghai (CN)
- (73) Assignee: **Seikilife (Shanghai) Housewares Co., Ltd.**, Shanghai (CN)
- (\*\*) Term: **15 Years**
- (21) Appl. No.: **29/650,570**
- (22) Filed: **Jun. 7, 2018**
- (51) **LOC (12) Cl.** ..... **07-01**
- (52) **U.S. Cl.**  
USPC ..... **D7/507; D7/510; D7/532**
- (58) **Field of Classification Search**  
USPC ..... D7/507, 509, 510, 511, 529, 530, 531, D7/532, 523, 534, 536, 608, 392.1, 396.2, D7/300.2; D9/500, 501, 502, 503, 504, D9/539, 562, 443, 439, 440, 449  
CPC ..... A47G 19/22; A47G 19/2288; A47G 19/2205; A47G 19/2222; A47G 19/2233; A47G 19/2266; B65D 47/066  
See application file for complete search history.

FIG. 1 is a perspective view of a water bottle showing my new design;  
 FIG. 2 is a front view thereof;  
 FIG. 3 is a rear view thereof;  
 FIG. 4 is a left view thereof;  
 FIG. 5 is a right view thereof;  
 FIG. 6 is a top view thereof;  
 FIG. 7 is a bottom view thereof;  
 FIG. 8 is an exploded perspective view thereof;  
 FIG. 9 is an exploded front view thereof;  
 FIG. 10 is an exploded rear view thereof;  
 FIG. 11 is an exploded left view thereof;  
 FIG. 12 is an exploded right view thereof;  
 FIG. 13 is a top view thereof;  
 FIG. 14 is a bottom view thereof;  
 FIG. 15 is a perspective view of the top bottle portion with the bottom cup portion removed to show details not disclosed in other views;  
 FIG. 16 is a front view thereof;  
 FIG. 17 is a rear view thereof;  
 FIG. 18 is a left view thereof;  
 FIG. 19 is a right view thereof;  
 FIG. 20 is a top view thereof;  
 FIG. 21 is a bottom view thereof;  
 FIG. 22 is a perspective view of the bottom cup portion with the top bottle portion removed to show details not disclosed in other views;  
 FIG. 23 is a front view thereof;  
 FIG. 24 is a rear view thereof;  
 FIG. 25 is a left view thereof;  
 FIG. 26 is a right view thereof;  
 FIG. 27 is a top view thereof; and  
 FIG. 28 is a bottom view thereof.  
 The broken lines in the drawings depict portions of the water bottle that form no part of the claimed design.

(56) **References Cited**

**U.S. PATENT DOCUMENTS**

- D727,171 S \* 4/2015 Marina ..... D7/300.1
- D731,856 S \* 6/2015 Hill ..... A47G 19/2266  
D7/532
- D768,507 S \* 10/2016 Hotell ..... D9/738
- 9,505,527 B1 \* 11/2016 Campbell ..... B65D 1/0246
- D786,620 S \* 5/2017 Nickley ..... D7/511
- D790,279 S \* 6/2017 Izen ..... D7/523

(Continued)

*Primary Examiner* — Jae Liang

(74) *Attorney, Agent, or Firm* — Wang Law Firm, Inc.

(57) **CLAIM**

The ornamental design for a water bottle, as shown and described.

**1 Claim, 28 Drawing Sheets**

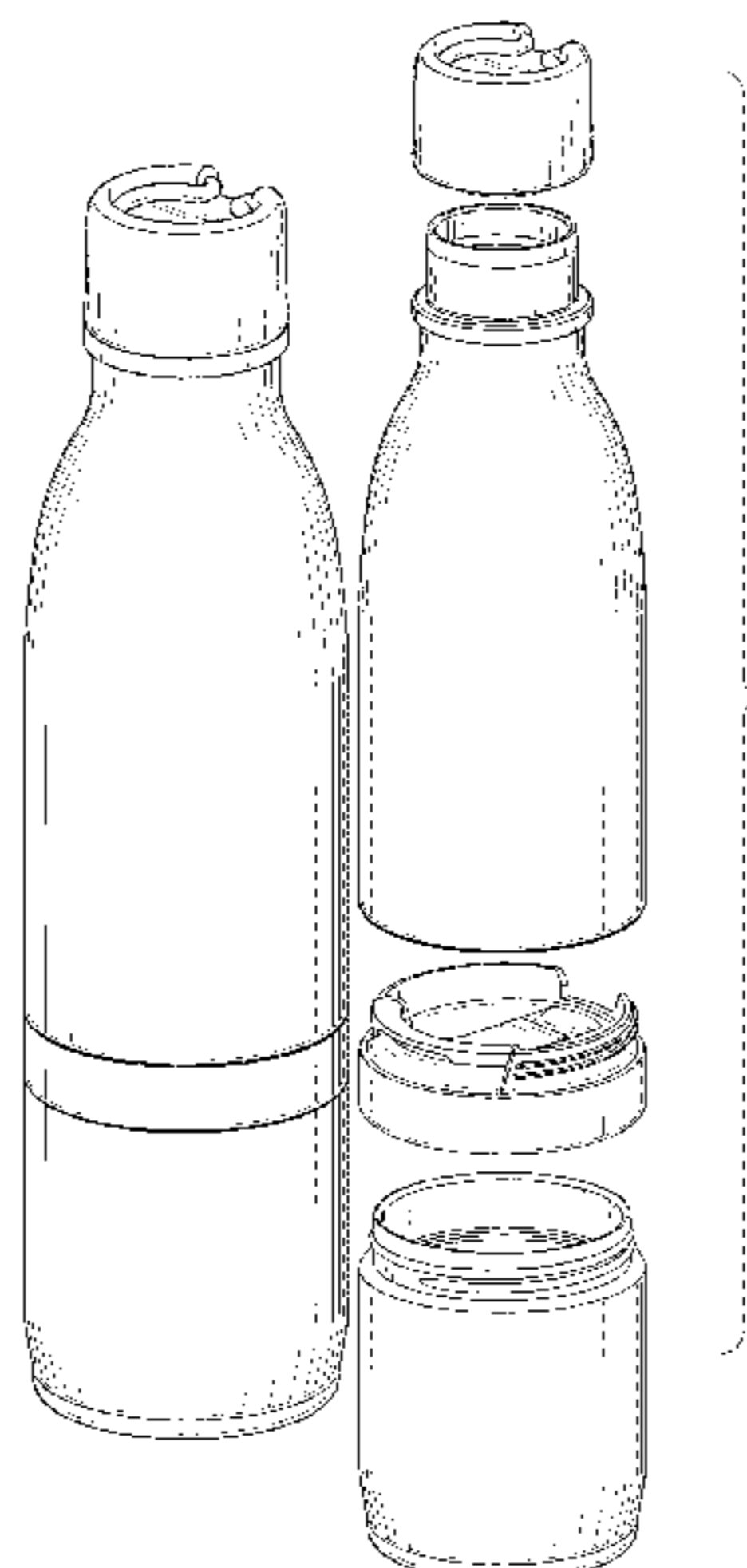

(56)

**References Cited**

U.S. PATENT DOCUMENTS

D799,323	S	*	10/2017	Verde	.....	D9/503
D805,918	S	*	12/2017	Matthieu	.....	D9/500
D814,241	S	*	4/2018	Nickley	.....	D7/510
D818,826	S	*	5/2018	Jovanovic	.....	D9/500
D830,784	S	*	10/2018	Moore	.....	D7/608
D832,651	S	*	11/2018	Wiet	.....	D7/511
D846,355	S	*	4/2019	Pisarevsky	.....	D7/511
D850,206	S	*	6/2019	Lyons	.....	D7/507
D856,082	S	*	8/2019	Yao	.....	D7/507
D856,083	S	*	8/2019	Lawson-Shanks	.....	D7/507
D861,431	S	*	10/2019	Demopoulos	.....	D7/507
D862,993	S	*	10/2019	Allsop	.....	D7/608
2018/0312322	A1	*	11/2018	Canales Kell	.....	B65D 1/04
2018/0353011	A1	*	12/2018	Pinelli	.....	A47J 41/028
2019/0009969	A1	*	1/2019	Kite	.....	B65D 81/3211

\* cited by examiner

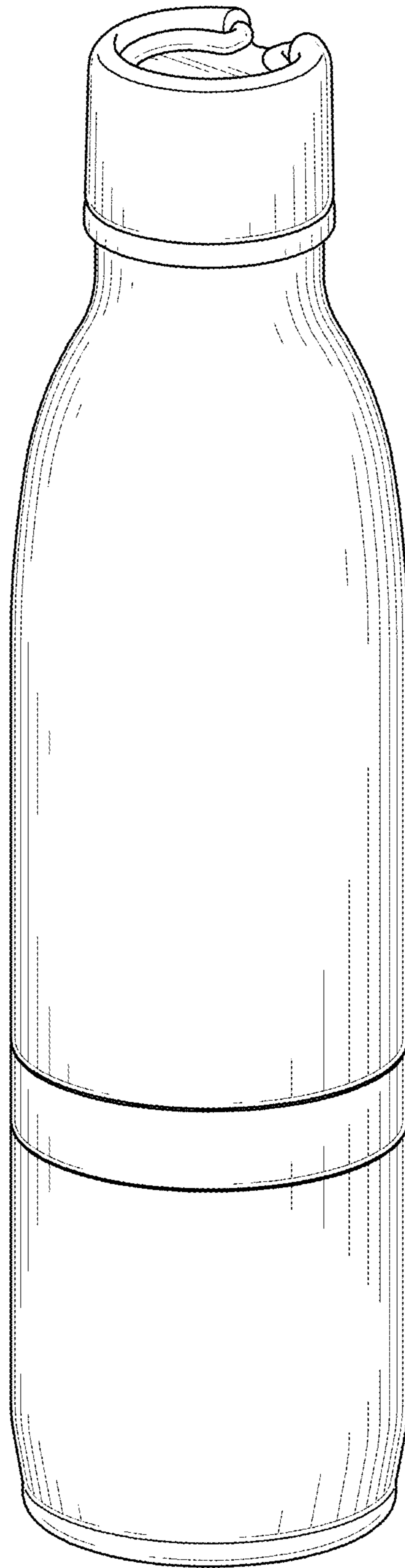

FIG. 1

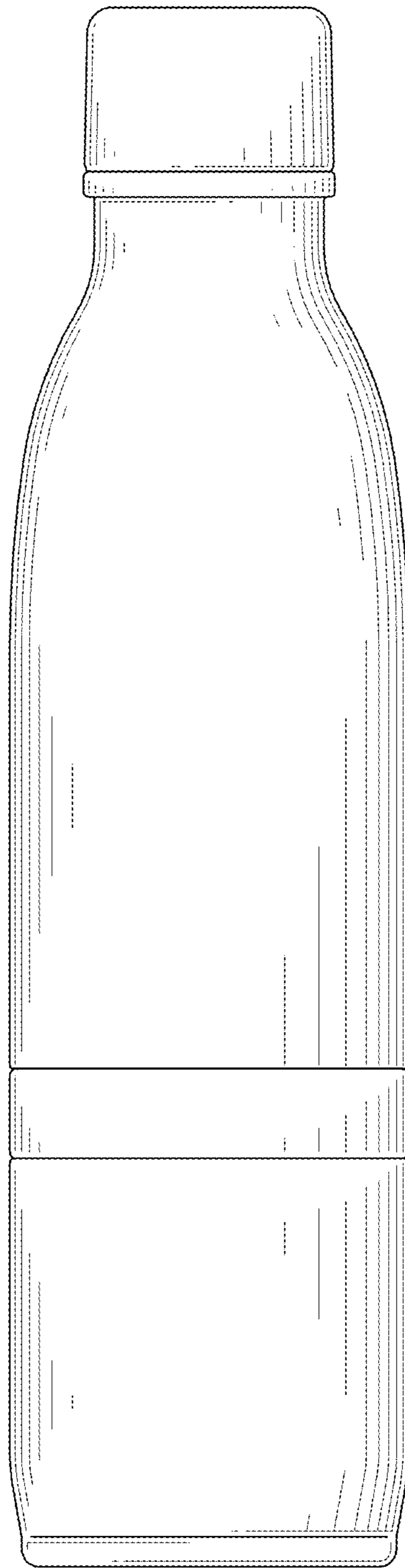

FIG. 2

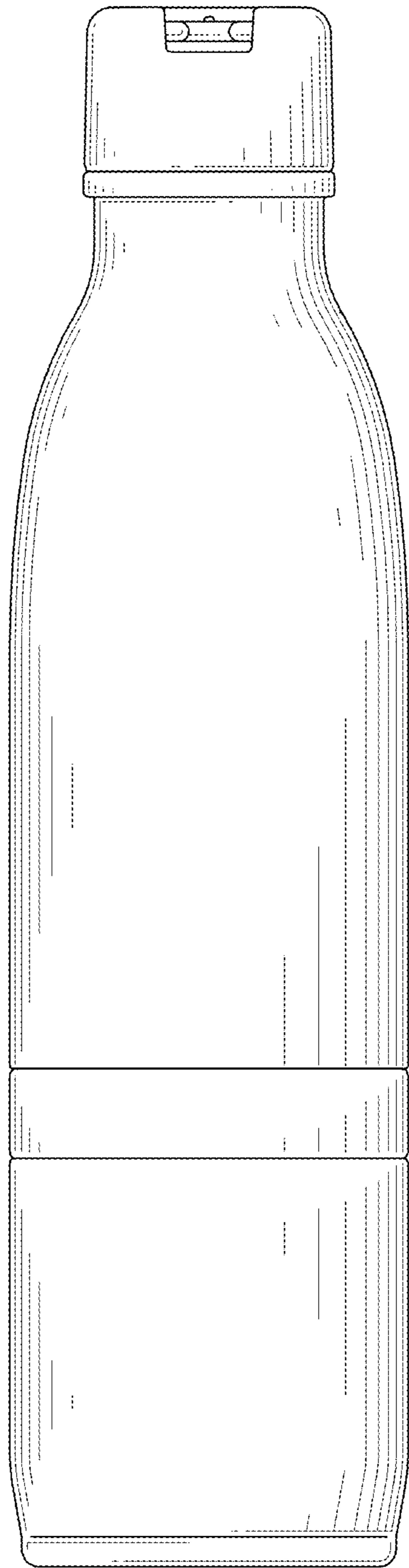

FIG. 3

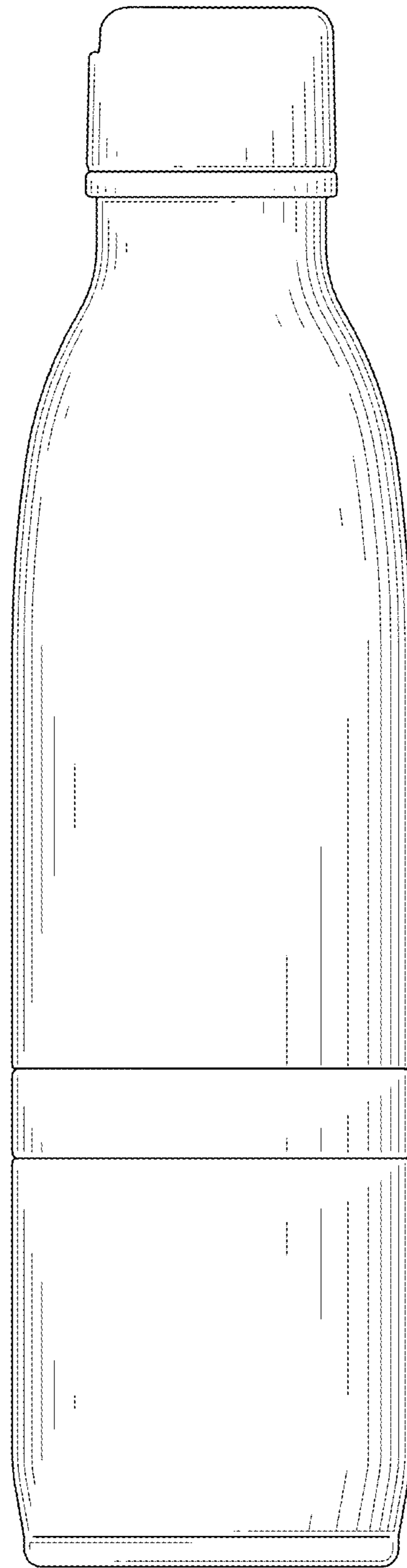

FIG. 4

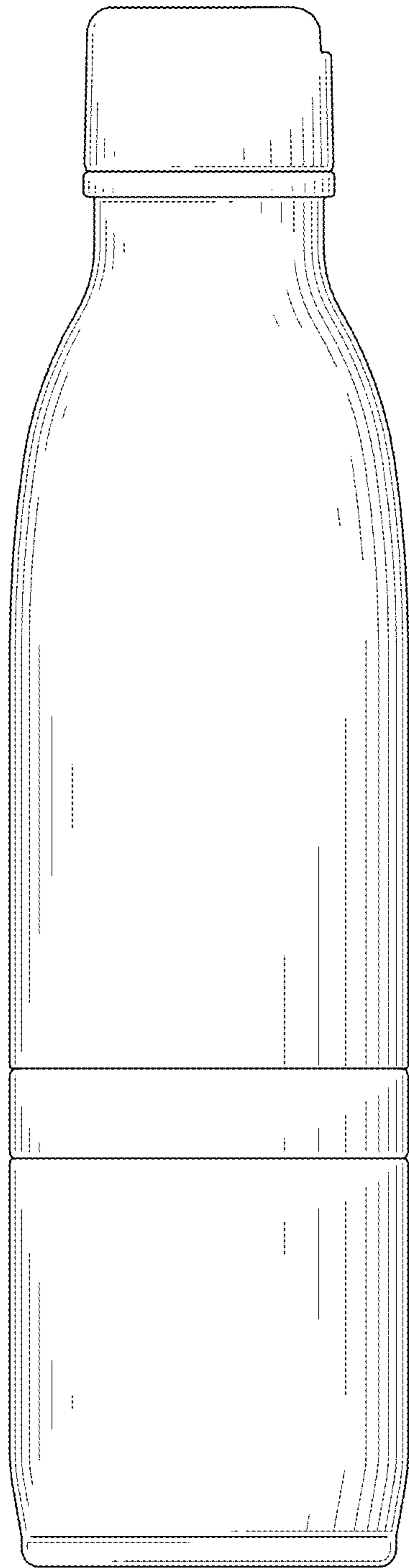

FIG. 5



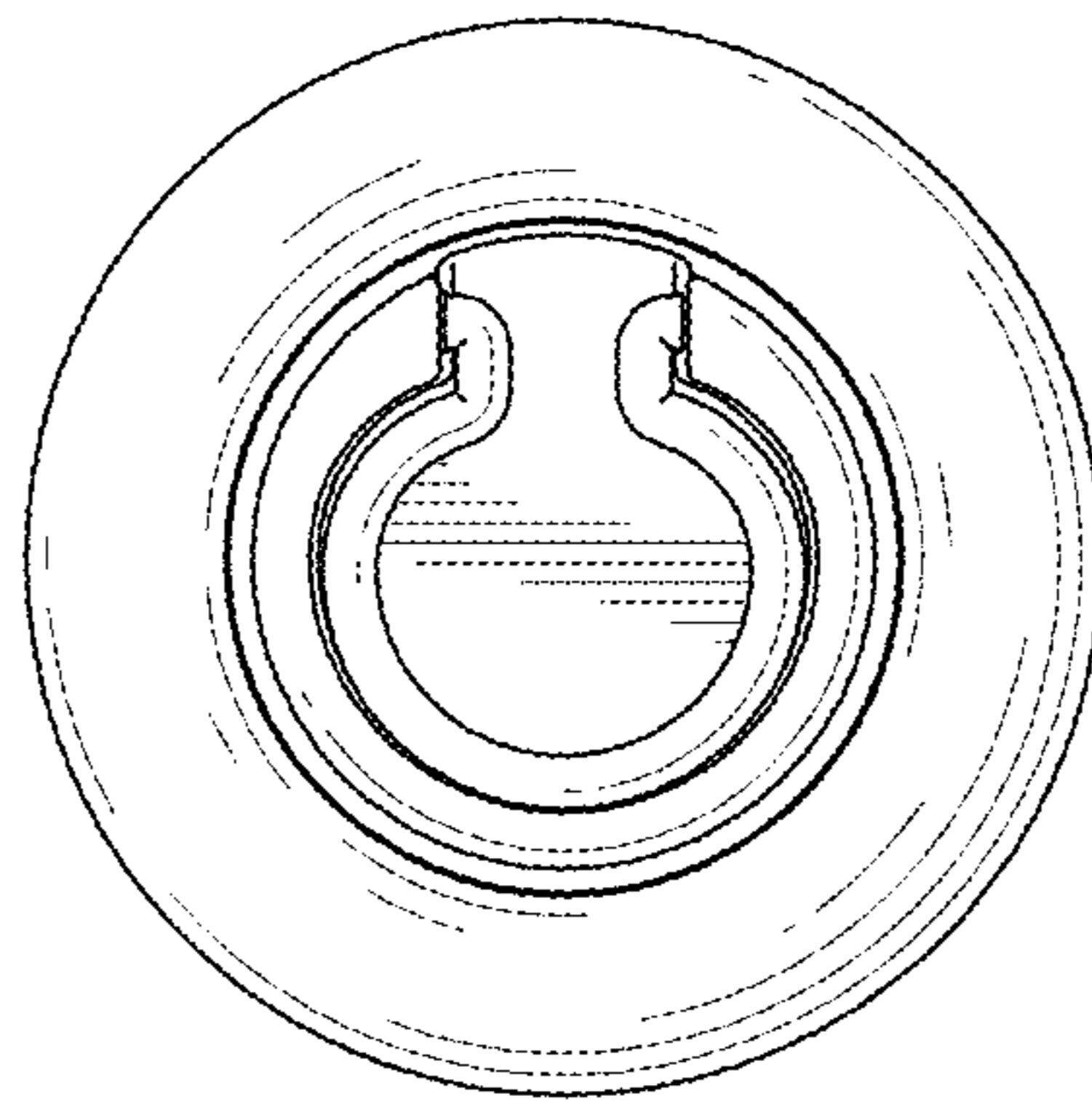

FIG. 6



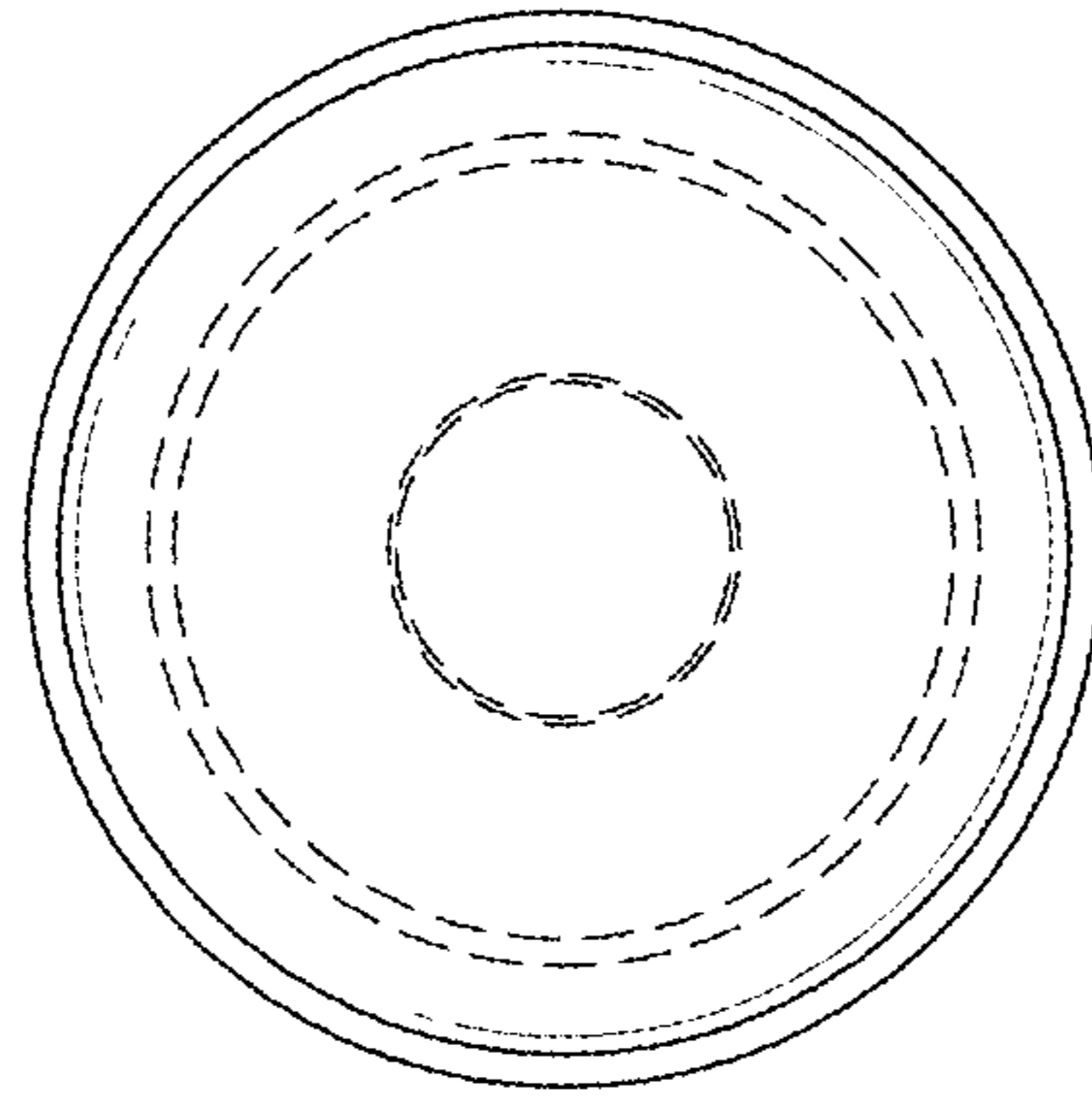

FIG. 7

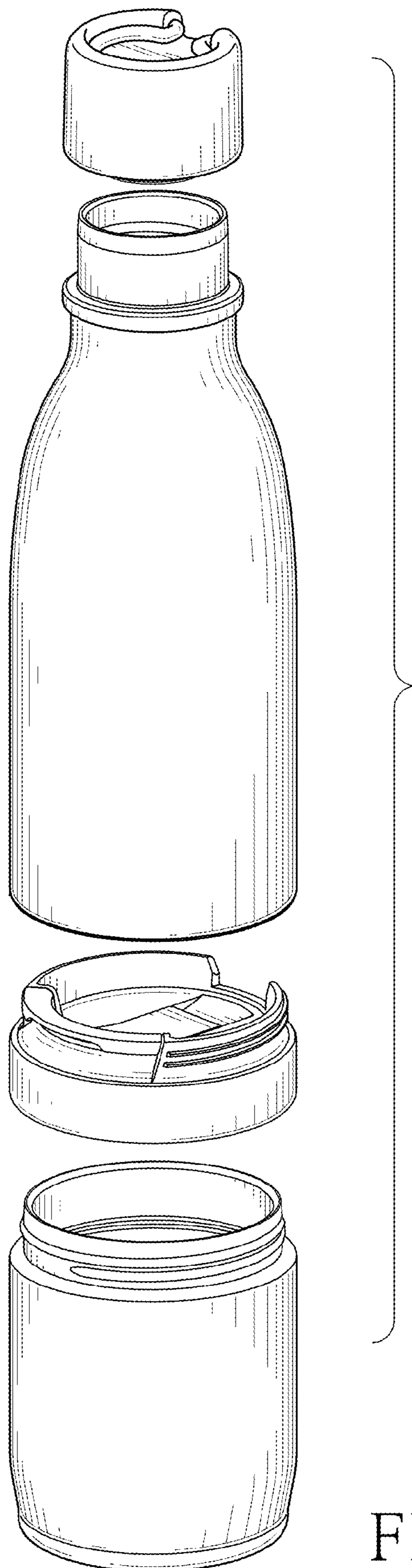

FIG. 8

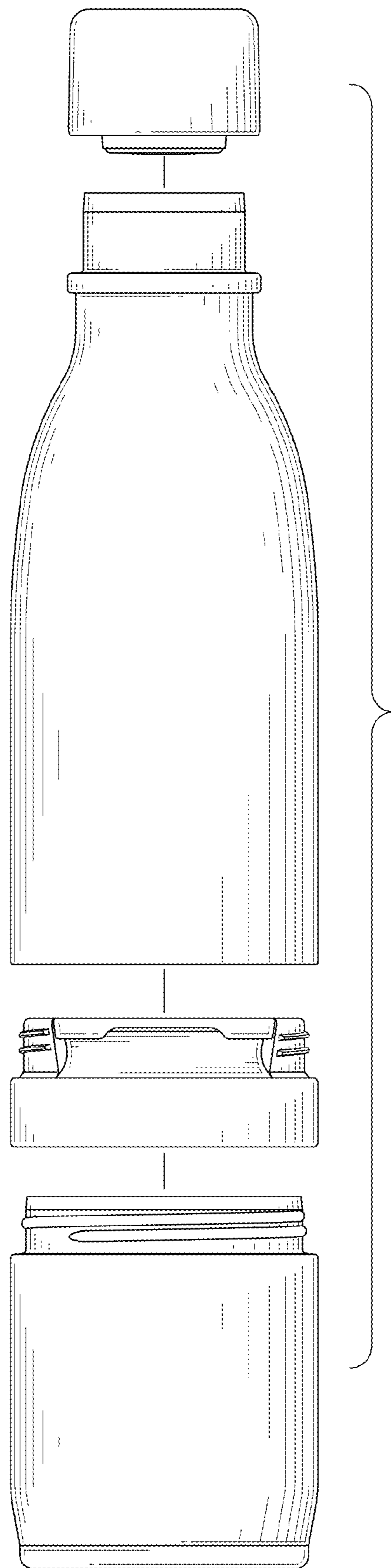

FIG. 9

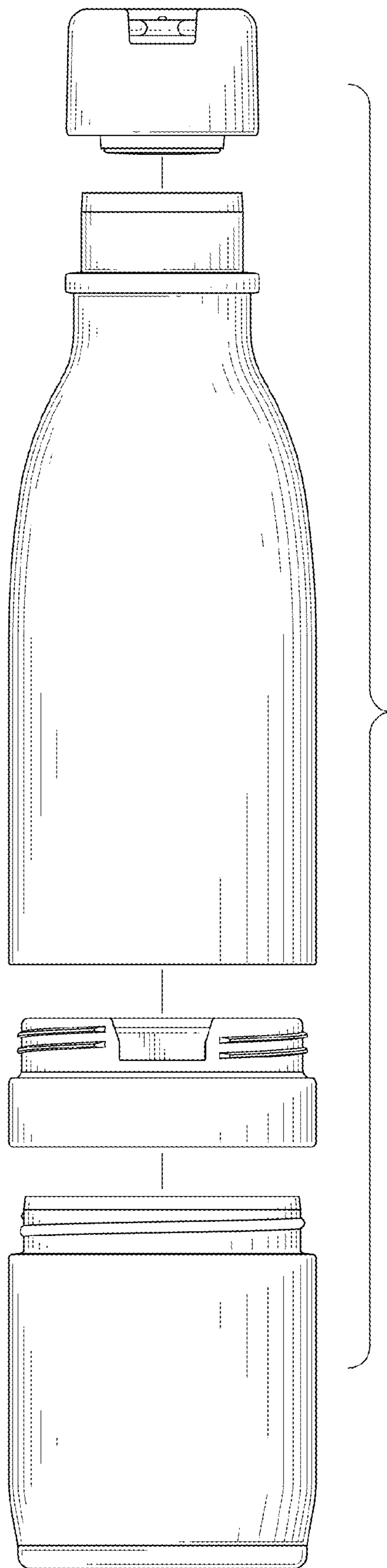

FIG. 10

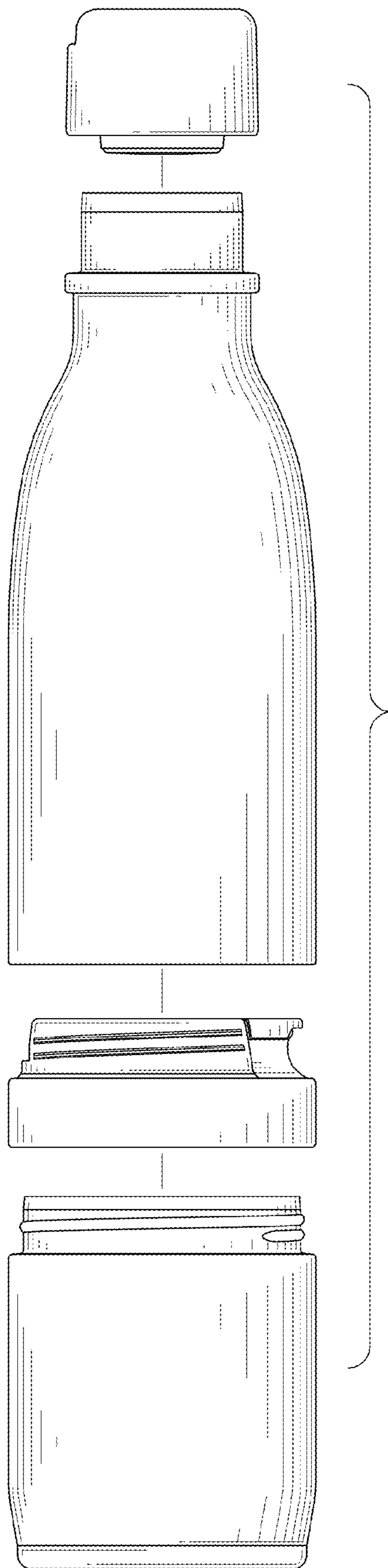

FIG. 11

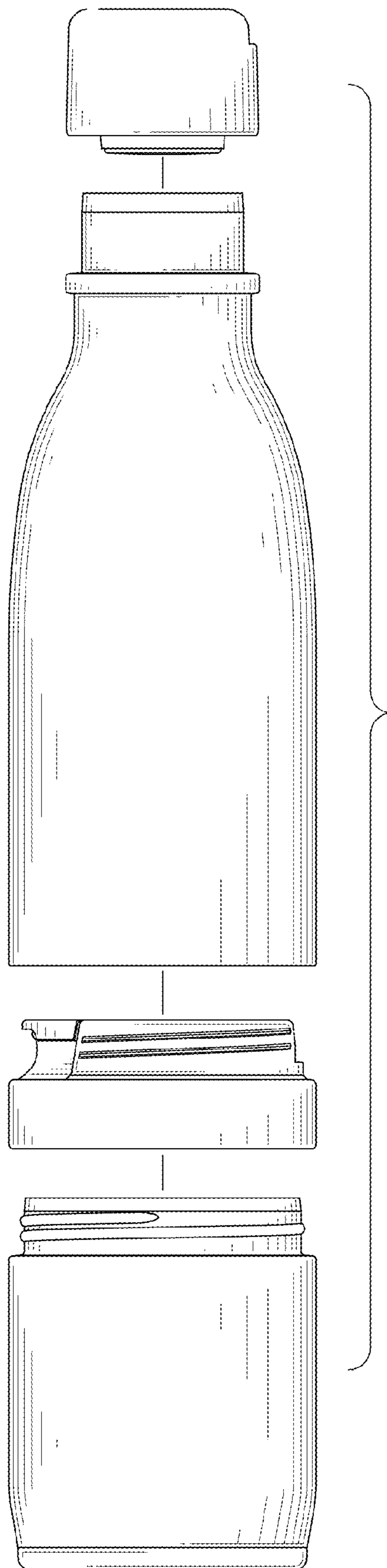

FIG. 12

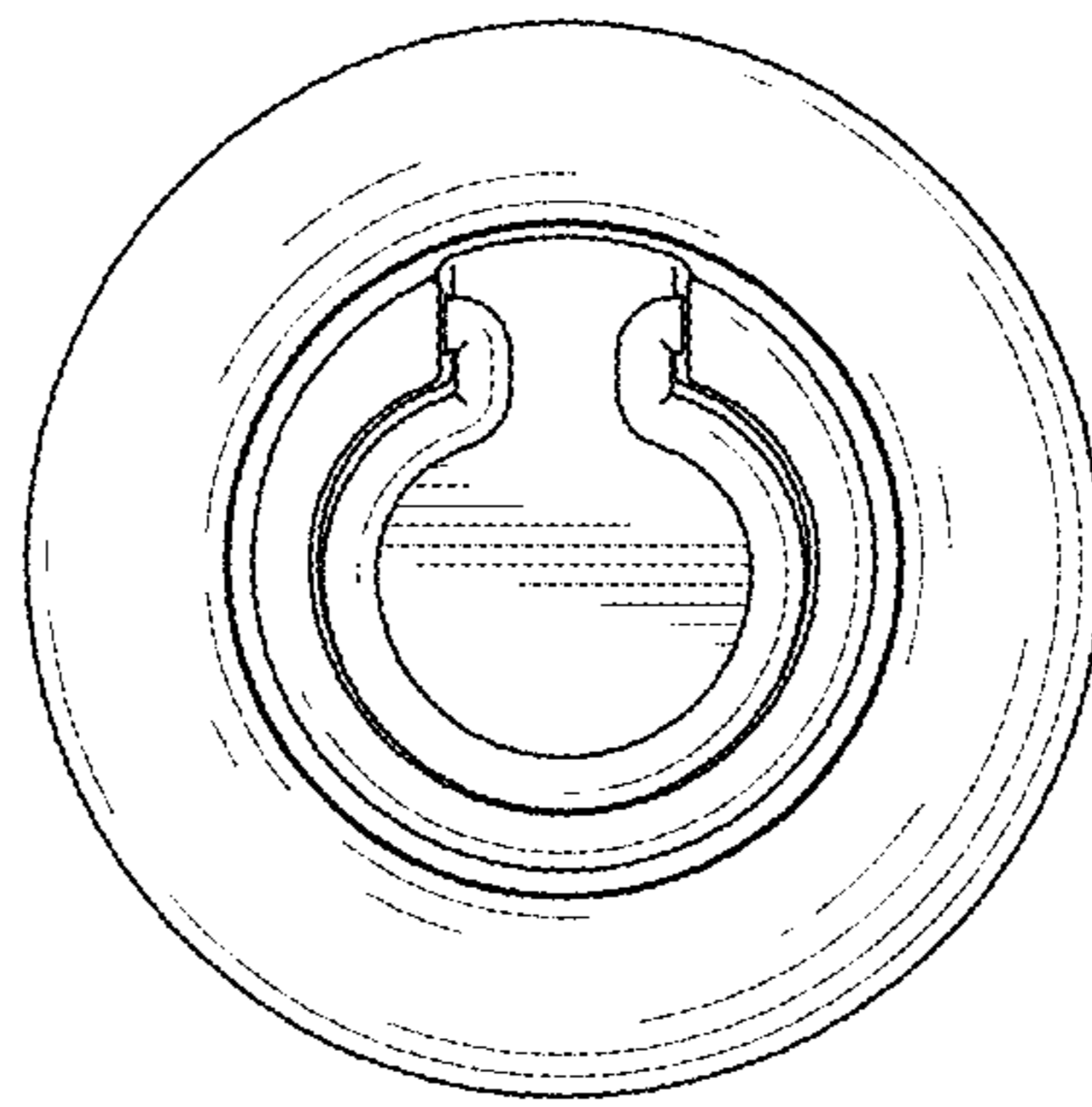

FIG. 13



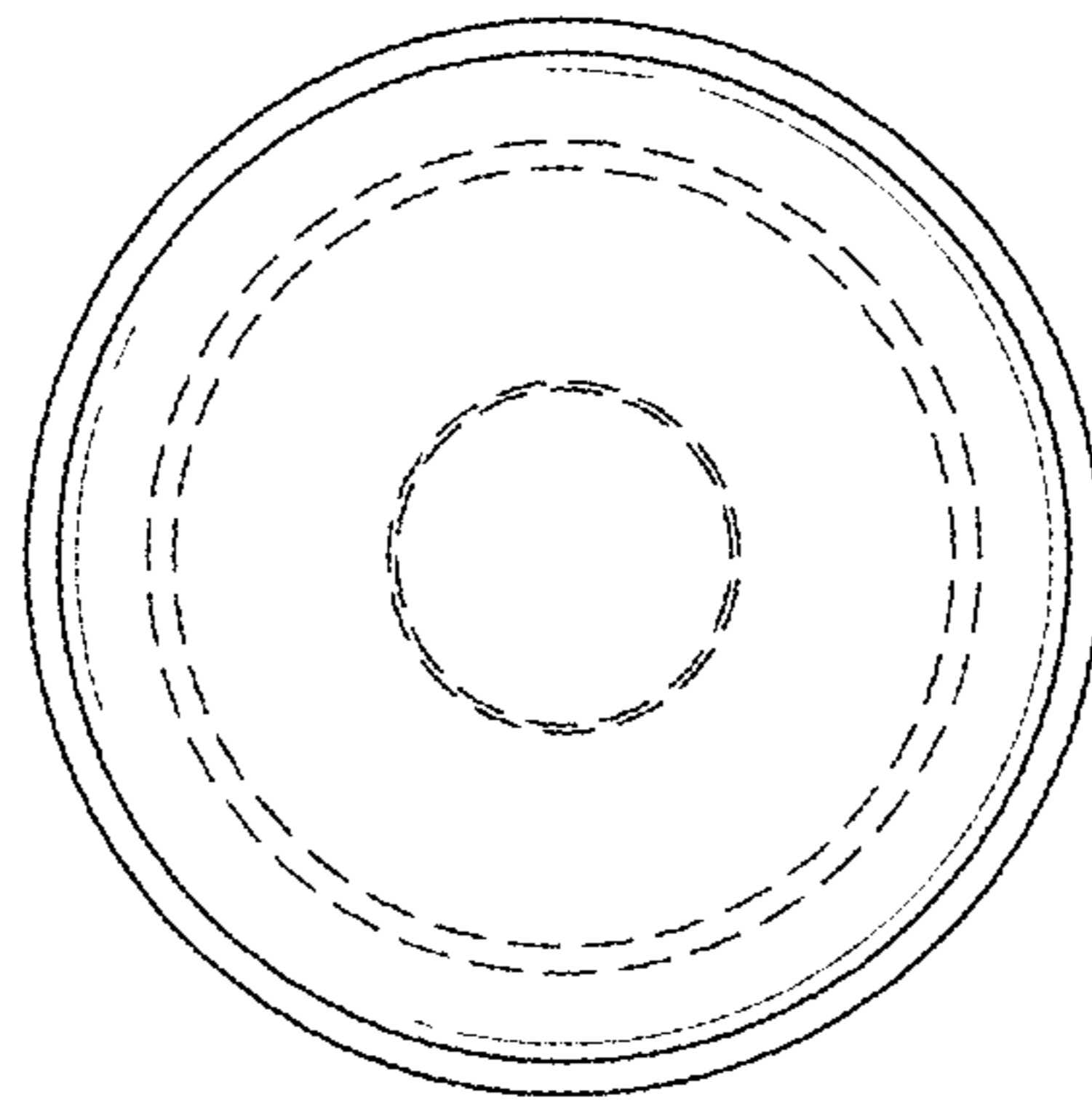

FIG. 14

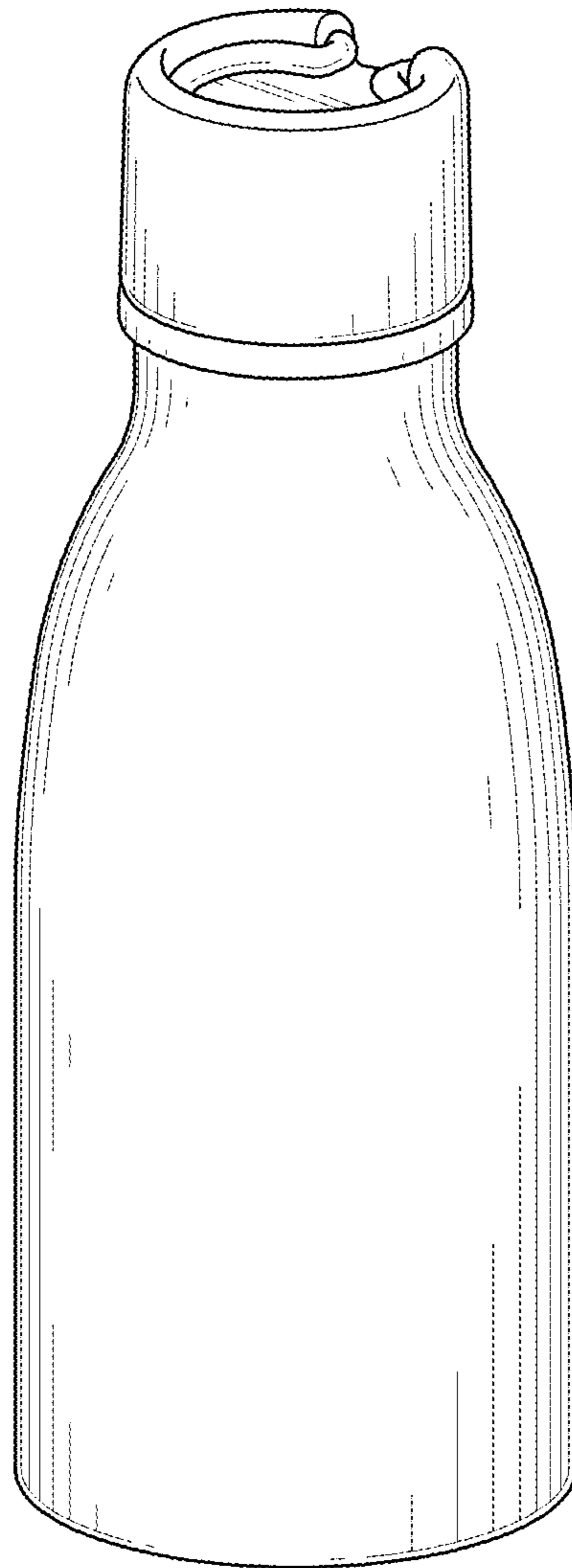

FIG. 15

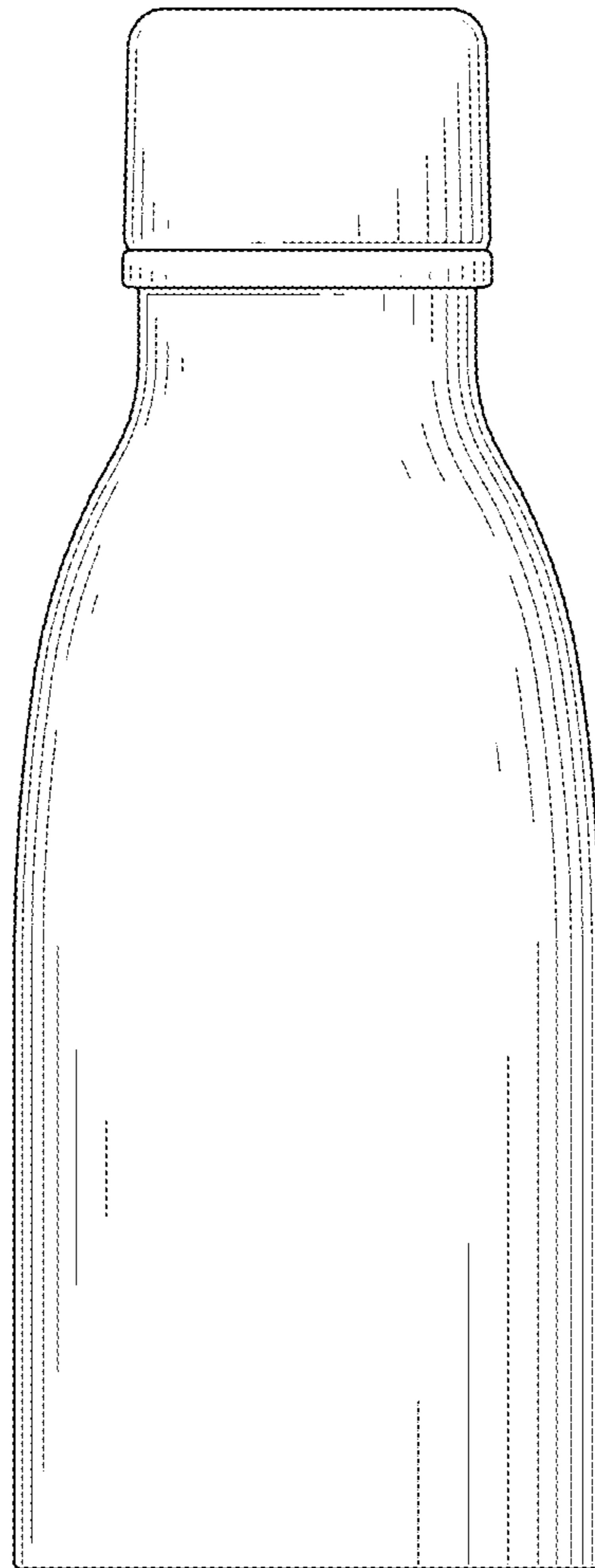

FIG. 16

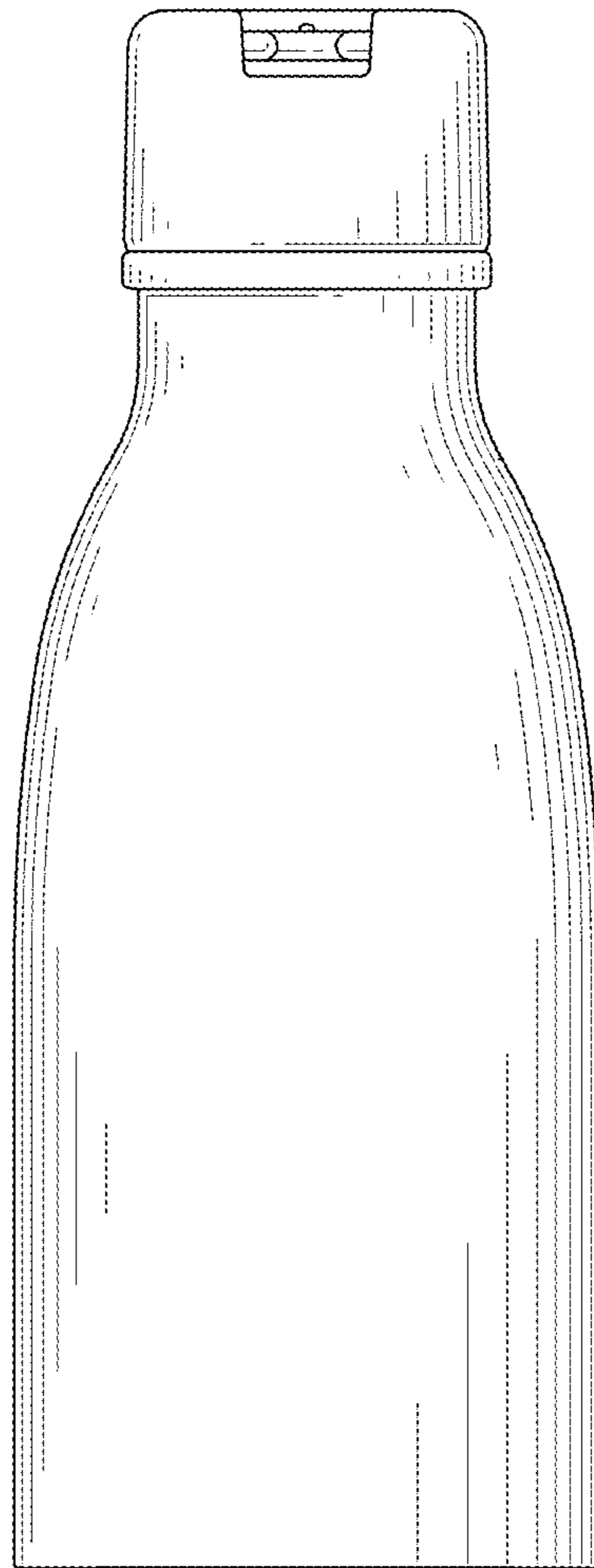

FIG. 17

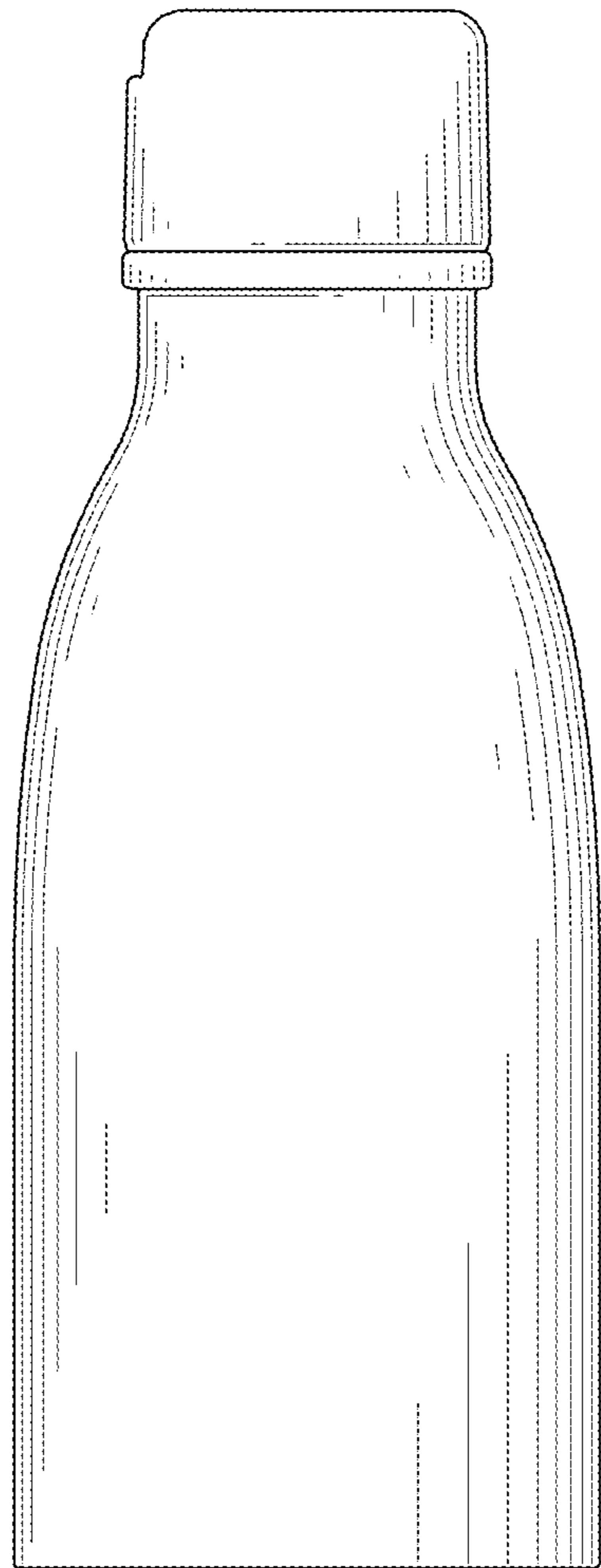

FIG. 18

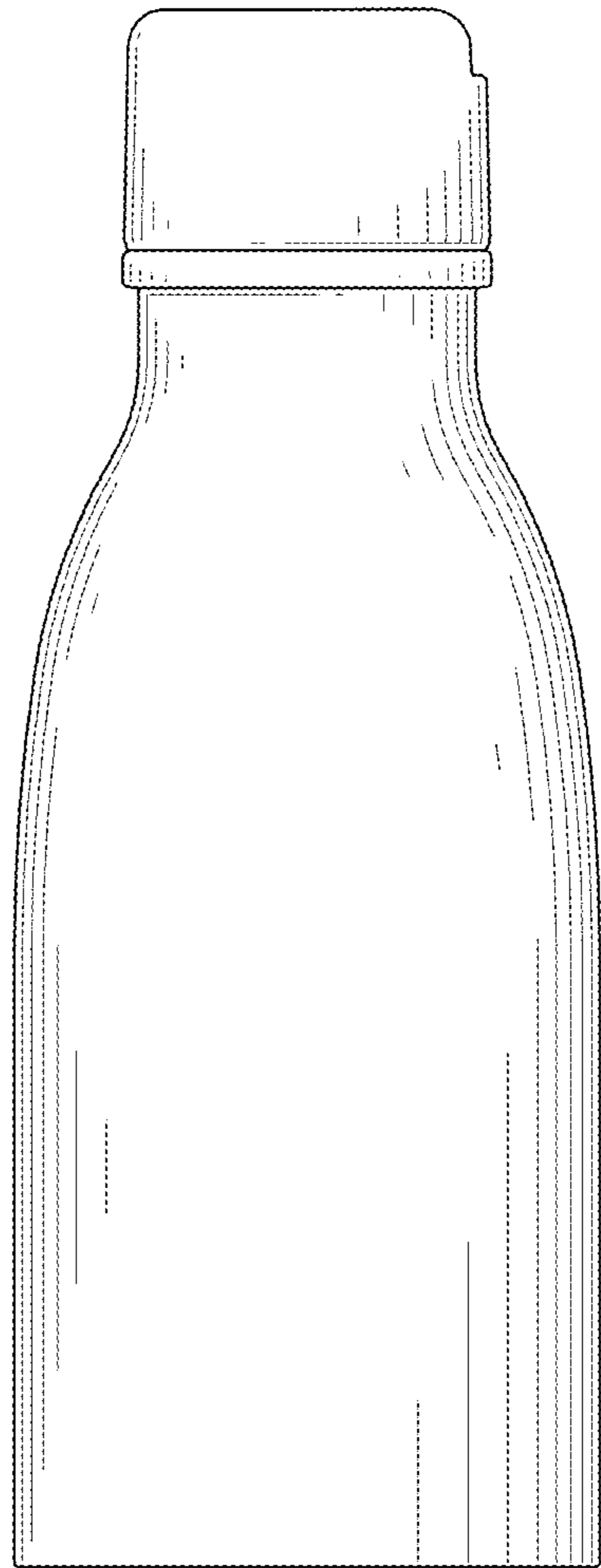

FIG. 19

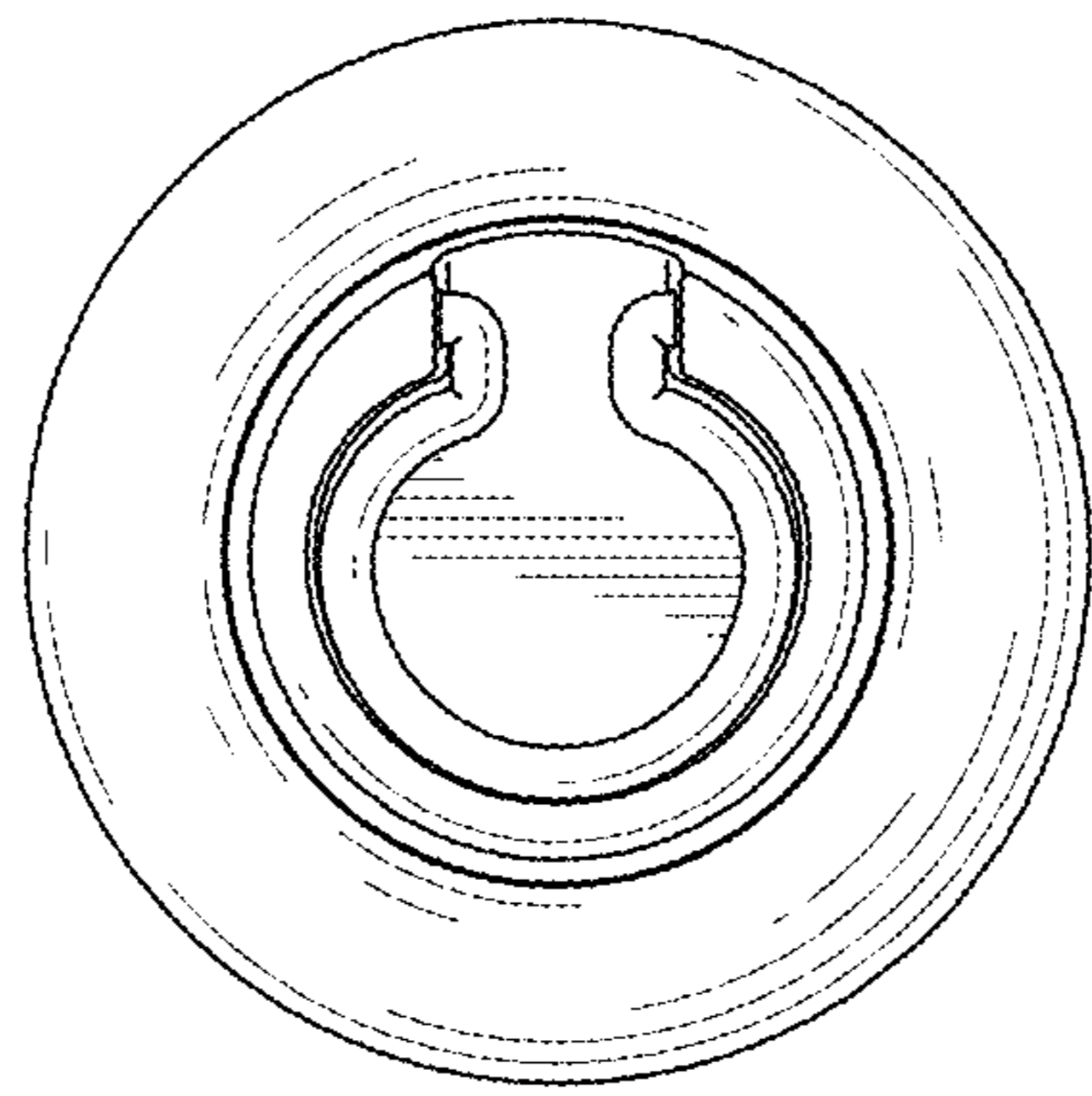

FIG. 20



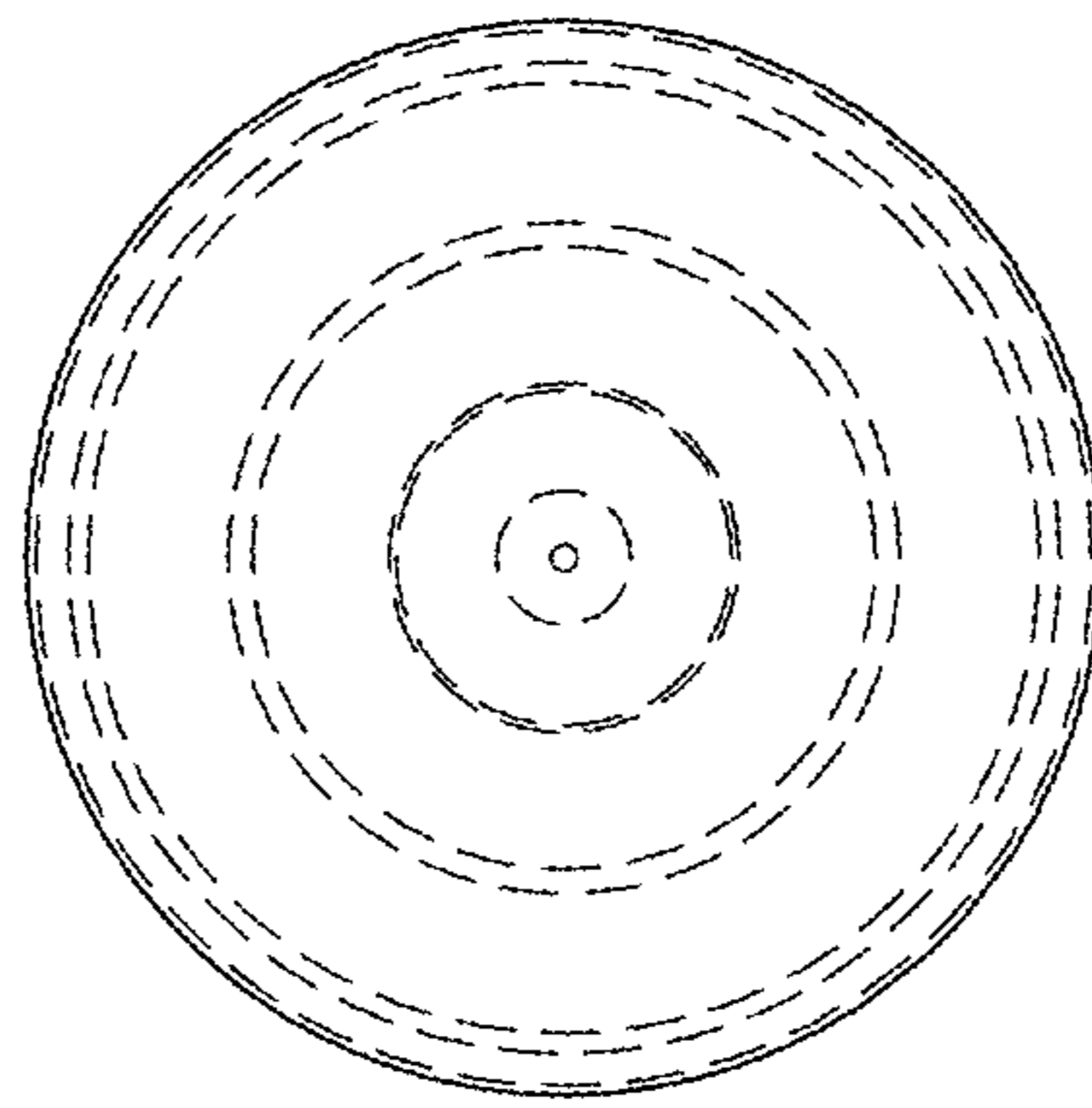

FIG. 21

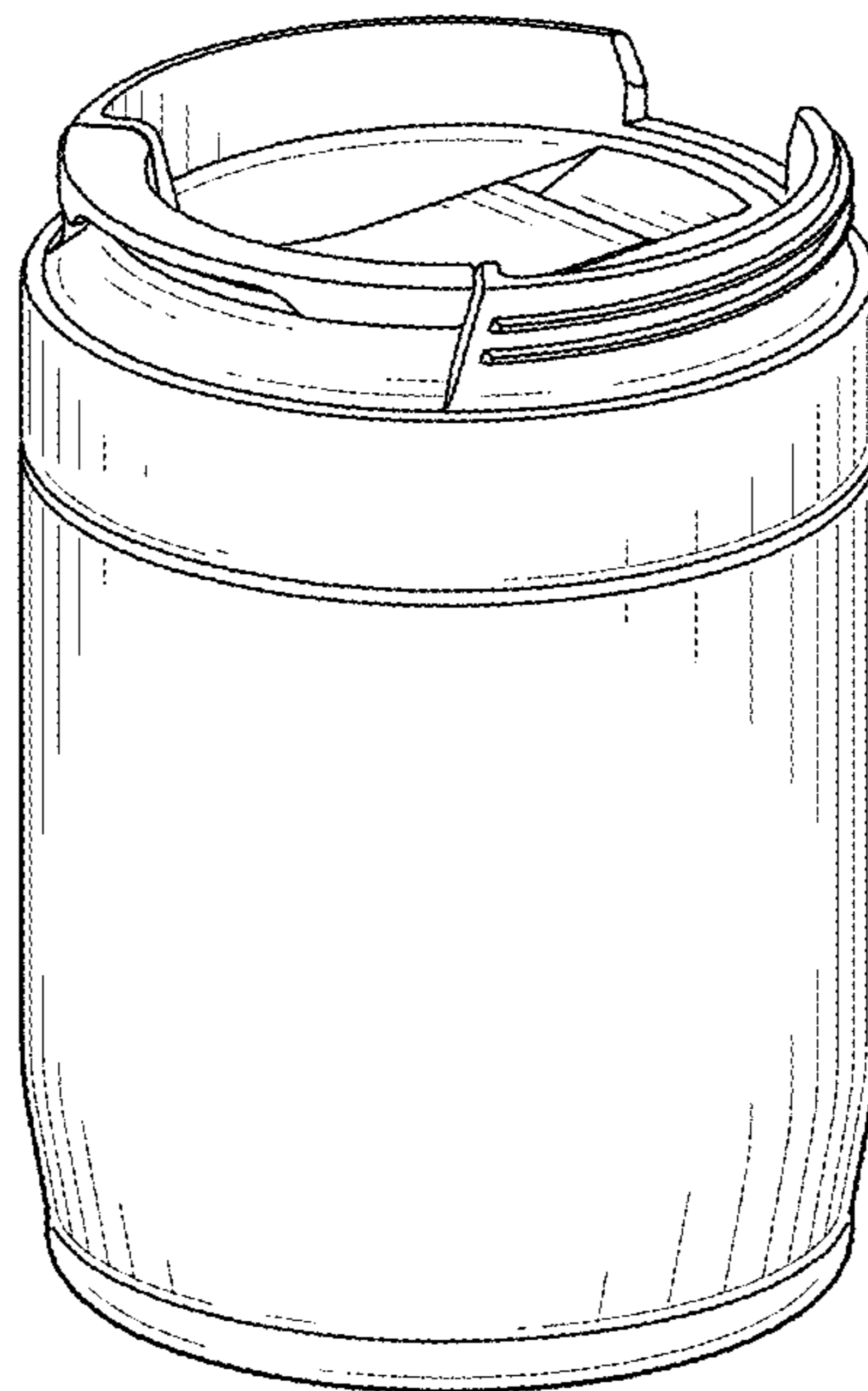

FIG. 22

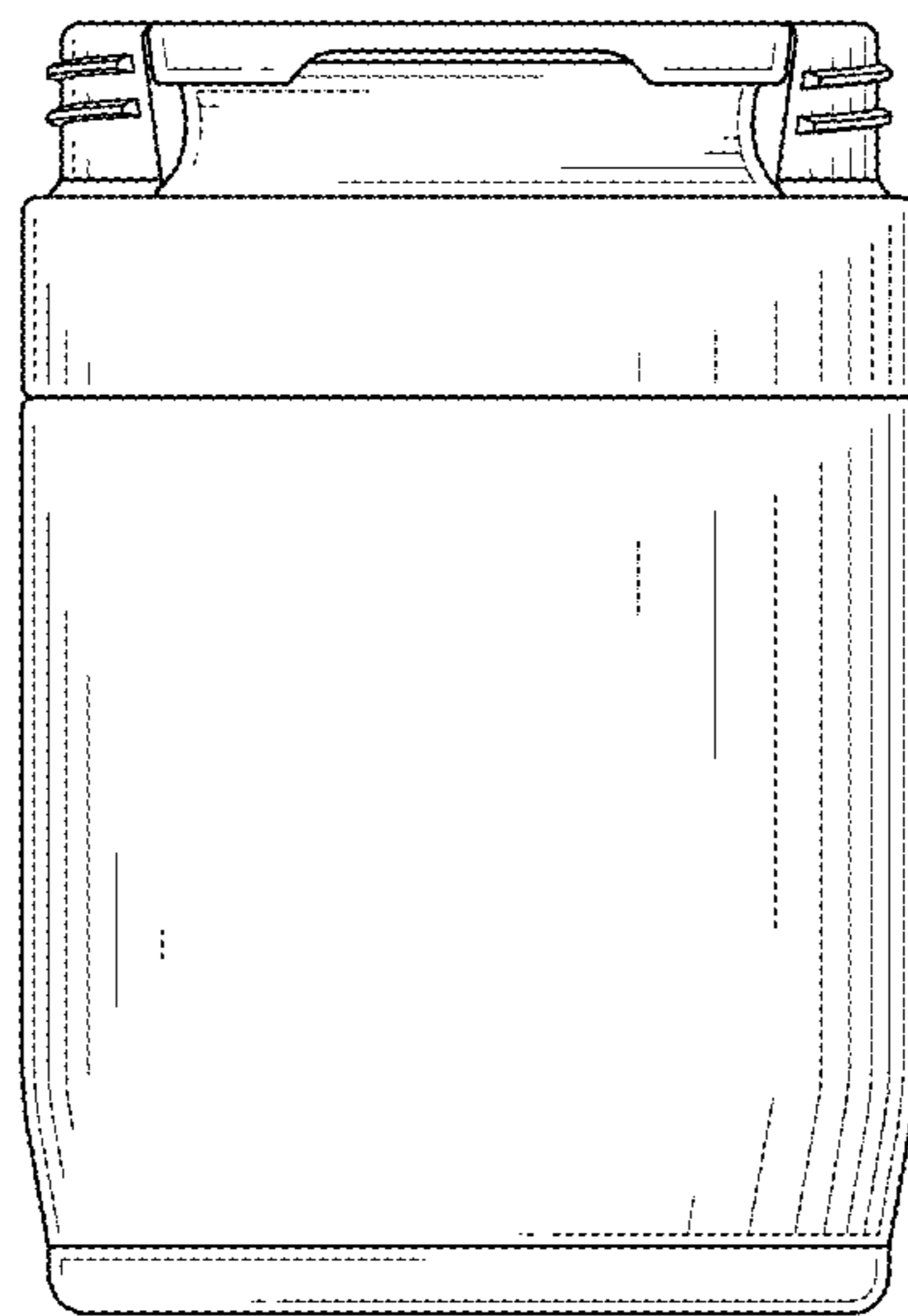

FIG. 23

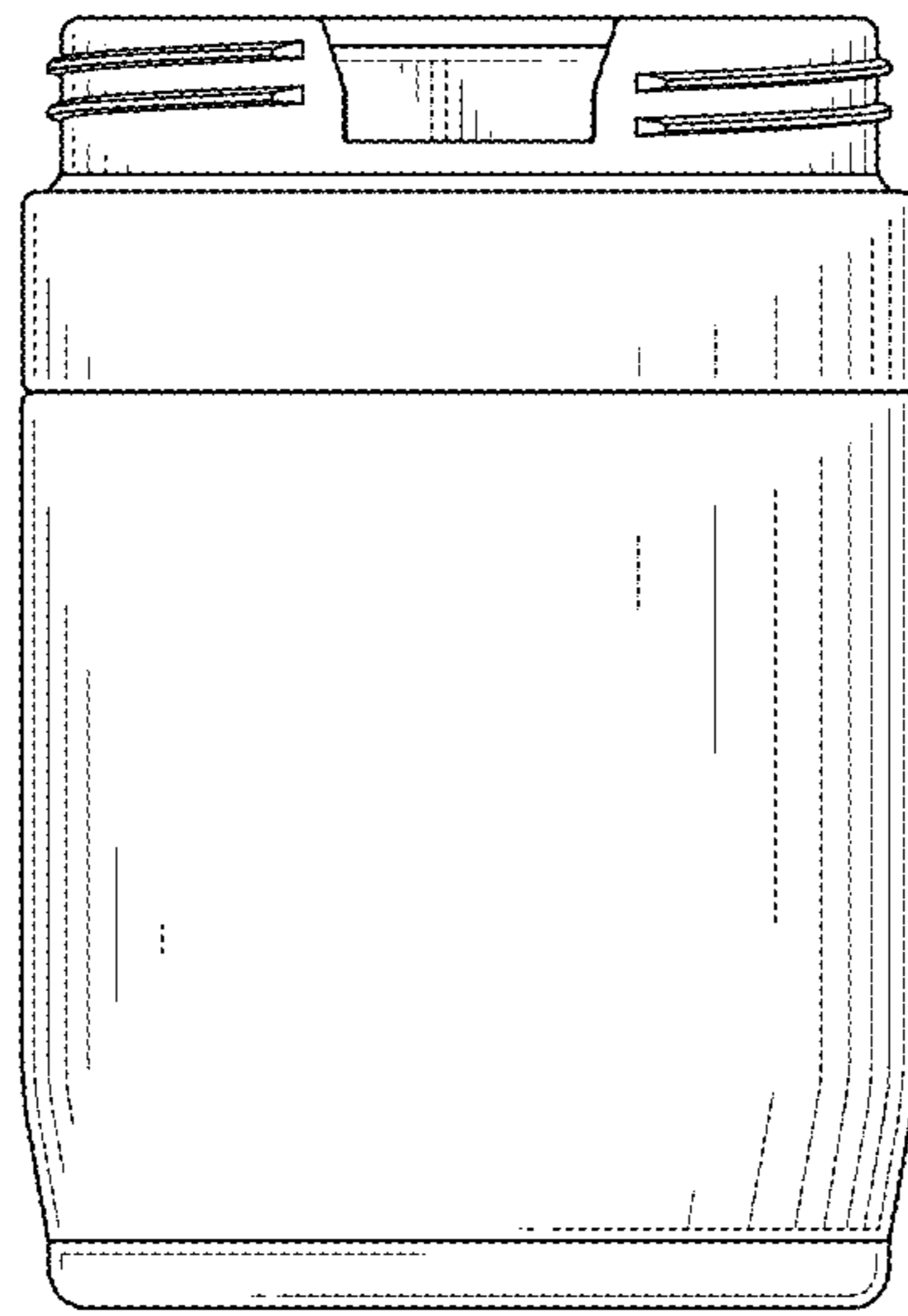

FIG. 24

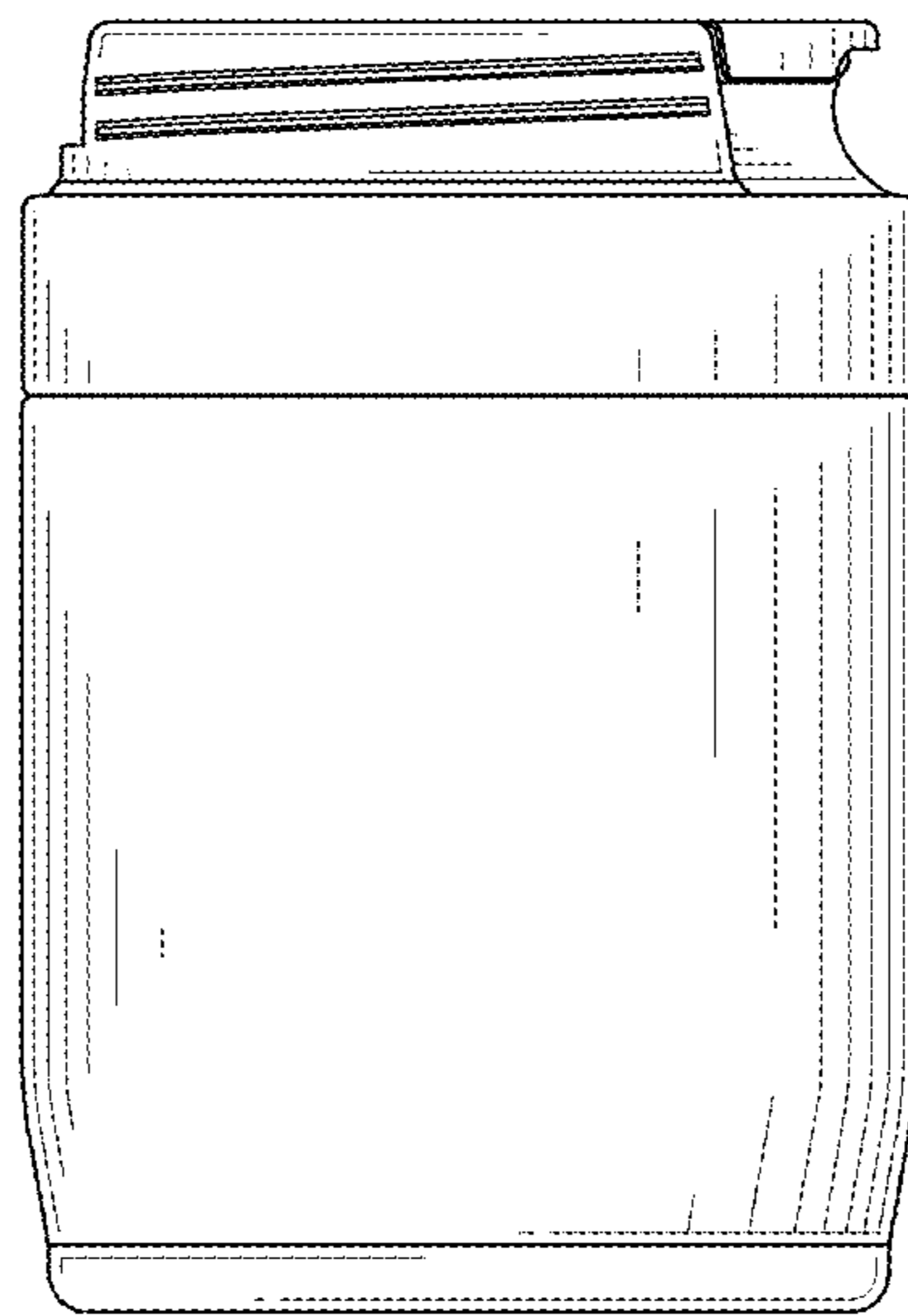

FIG. 25

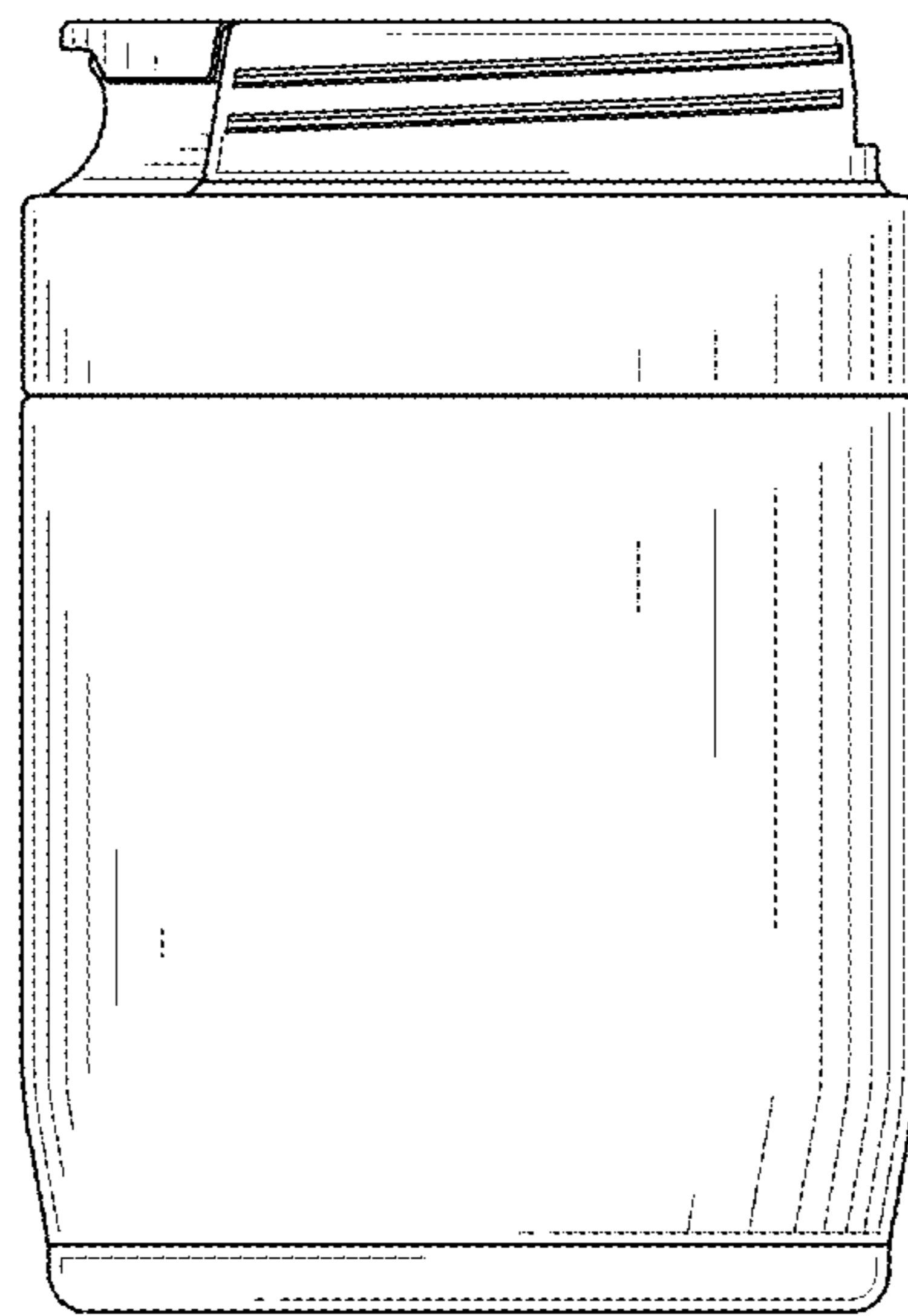

FIG. 26

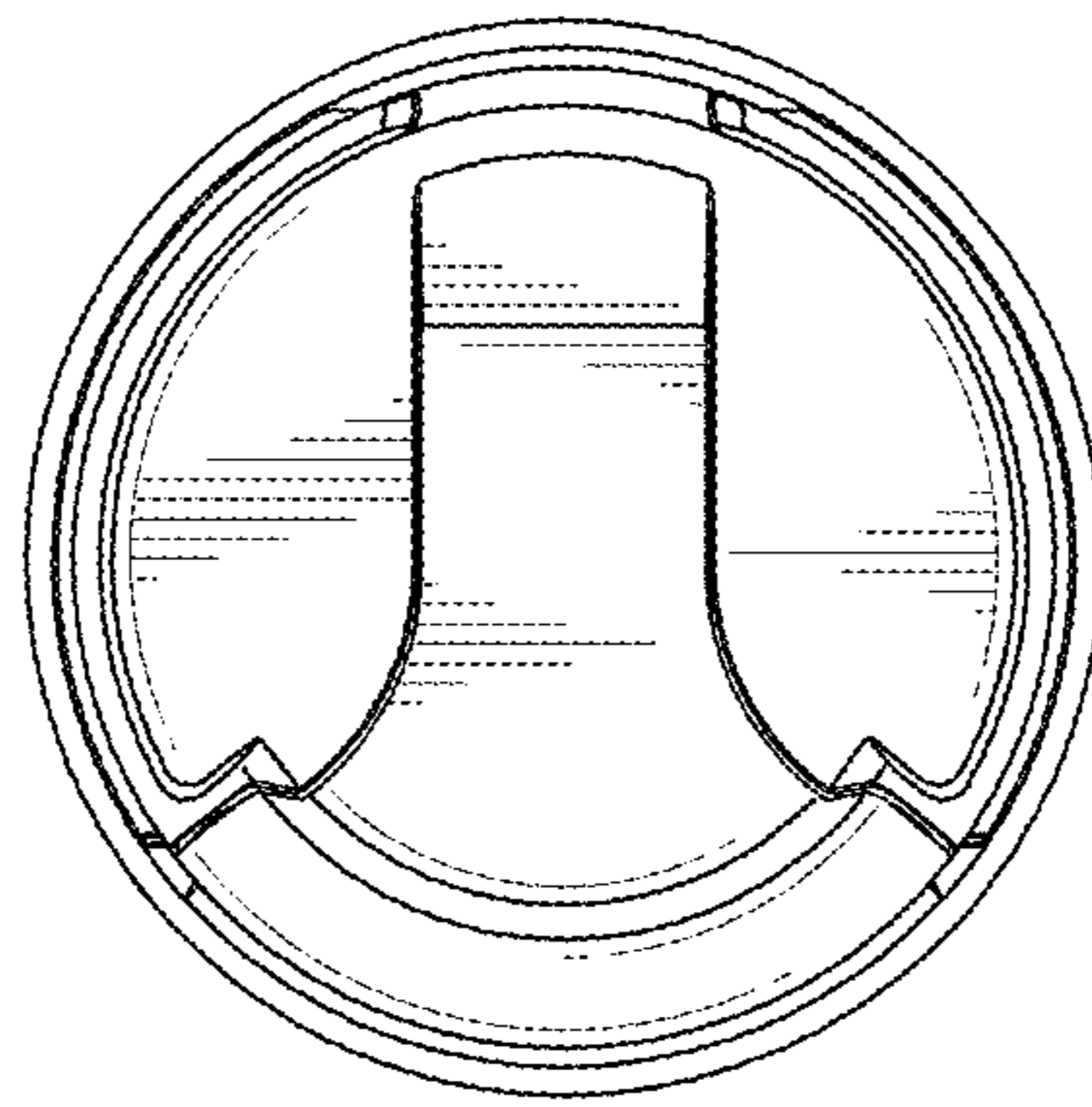

FIG. 27



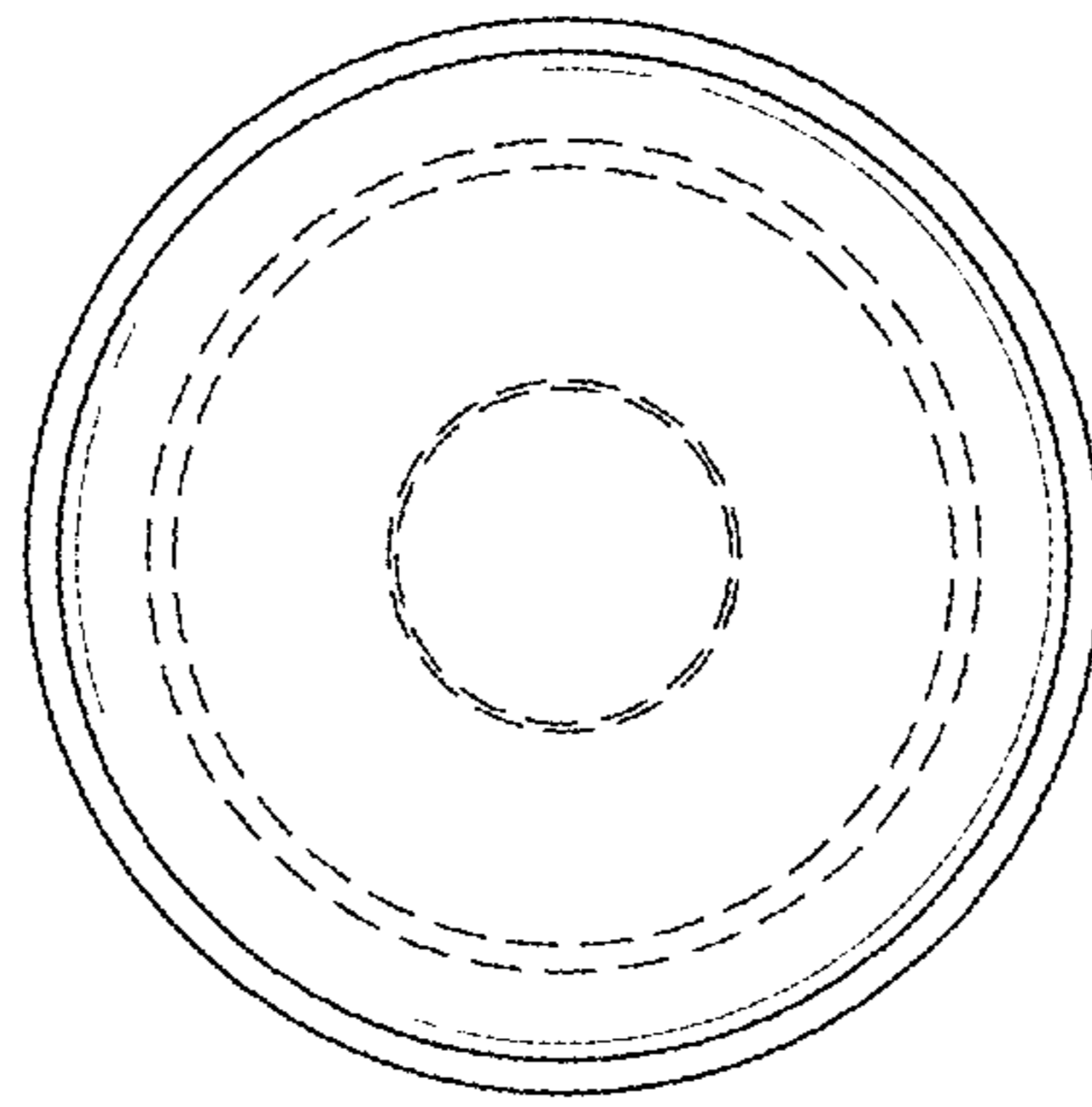

FIG. 28