



US00D878784S

(12) **United States Design Patent**
Hurford

(10) **Patent No.:** **US D878,784 S**

(45) **Date of Patent:** **** Mar. 24, 2020**

(54) **CHAIR**

(71) Applicant: **Okamura Corporation**, Yokohama-shi,
Kanagawa (JP)

(72) Inventor: **Alexander Hurford**, Yokohama (JP)

(73) Assignee: **Okamura Corporation**, Yokohama-shi,
Kanagawa (JP)

(**) Term: **15 Years**

(21) Appl. No.: **29/641,901**

(22) Filed: **Mar. 26, 2018**

(30) **Foreign Application Priority Data**

Sep. 26, 2017 (JP) 2017-020919
Sep. 26, 2017 (JP) 2017-020920
Sep. 26, 2017 (JP) 2017-020921

(51) **LOC (12) Cl.** **06-01**

(52) **U.S. Cl.**
USPC **D6/365**

(58) **Field of Classification Search**
USPC D6/356, 360, 364, 365, 335, 366, 367,
D6/375, 716, 719; D21/521, 533, 548
CPC A61H 2201/0149; B60N 2/06; B60N 2/20;
B60N 2/22; B60N 2/58; B60N 2/68;
B60N 2/80; B60N 2/643; B60N 2/888;
B60N 2/859; B60N 2/1615; B60N
2/7035; B60N 2/42745; B60N 2002/0272;
B60N 2205/35; B60N 2/0252; B60N
2/99; B64D 11/064; B64D 11/0646;
B64D 33/0021; B64D 33/00
See application file for complete search history.

(56) **References Cited**

U.S. PATENT DOCUMENTS

D138,511 S * 8/1944 Dreyfuss 297/445.1
D298,491 S * 11/1988 Haukvik D6/365

D316,936 S * 5/1991 Ekornes D6/365
D508,787 S * 8/2005 Natuzzi D6/364
D531,420 S * 11/2006 Kita D6/364
D600,033 S * 9/2009 Natuzzi D6/364
D611,263 S * 3/2010 Werner D6/366
D672,975 S * 12/2012 Rashid D6/335
D677,918 S * 3/2013 Citterio D6/366
D684,785 S * 6/2013 Hwangbo D6/367
D698,162 S * 1/2014 Kita D6/335
D701,719 S * 4/2014 Haase D6/719
D704,465 S * 5/2014 Massaud D6/364
D704,466 S * 5/2014 Massaud D6/364
D704,488 S * 5/2014 Massaud D6/716
D717,555 S * 11/2014 Massaud D6/364
D763,589 S * 8/2016 Mion D6/375
D799,844 S * 10/2017 Aamodt D6/366
9,828,101 B2 * 11/2017 Shih B64D 11/0646
D824,185 S * 7/2018 Wang D6/367
D824,689 S * 8/2018 Jongerius D6/375

(Continued)

Primary Examiner — Michael C Stout

Assistant Examiner — Paul D Bohannon

(74) *Attorney, Agent, or Firm* — Banner & Witcoff, Ltd.

(57) **CLAIM**

The ornamental design for a chair, as shown and described.

DESCRIPTION

FIG. 1 is a front perspective view of a chair showing my new design;
FIG. 2 is a rear perspective view thereof;
FIG. 3 is a front view thereof;
FIG. 4 is a rear view thereof;
FIG. 5 is a right side view thereof, the left side view being a mirror image thereof;
FIG. 6 is a top view thereof; and,
FIG. 7 is a bottom view thereof.
The broken lines shown in the drawings illustrate portions of the chair that form no part of the claimed design.

1 Claim, 7 Drawing Sheets

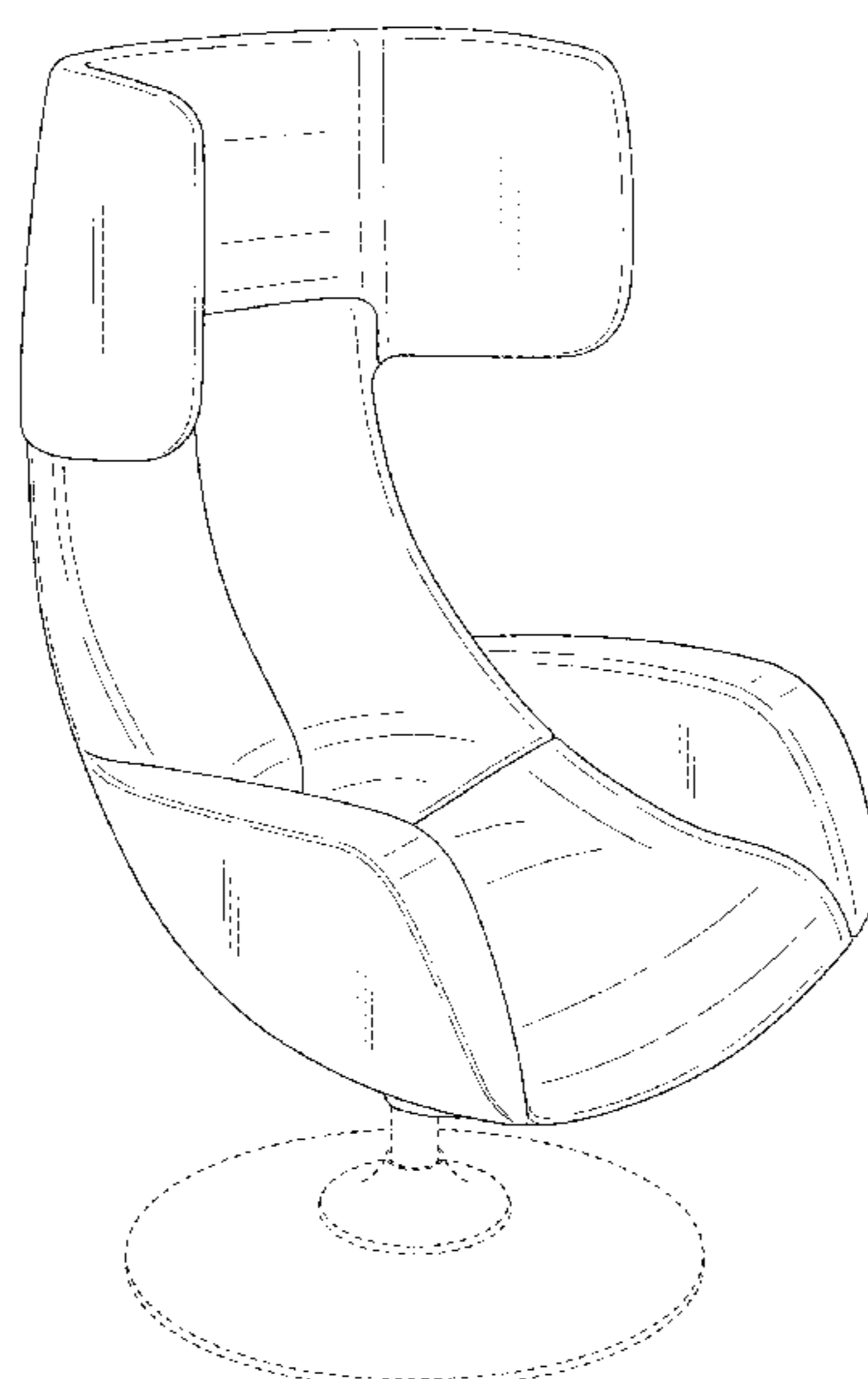

(56)

References Cited

U.S. PATENT DOCUMENTS

10,081,285 B2 * 9/2018 Kaneda B60N 2/99
10,144,312 B2 * 12/2018 Akaike B64D 11/0639
D839,622 S * 2/2019 Oyama D6/356
D848,162 S * 5/2019 Yin D6/335

* cited by examiner

Fig. 1

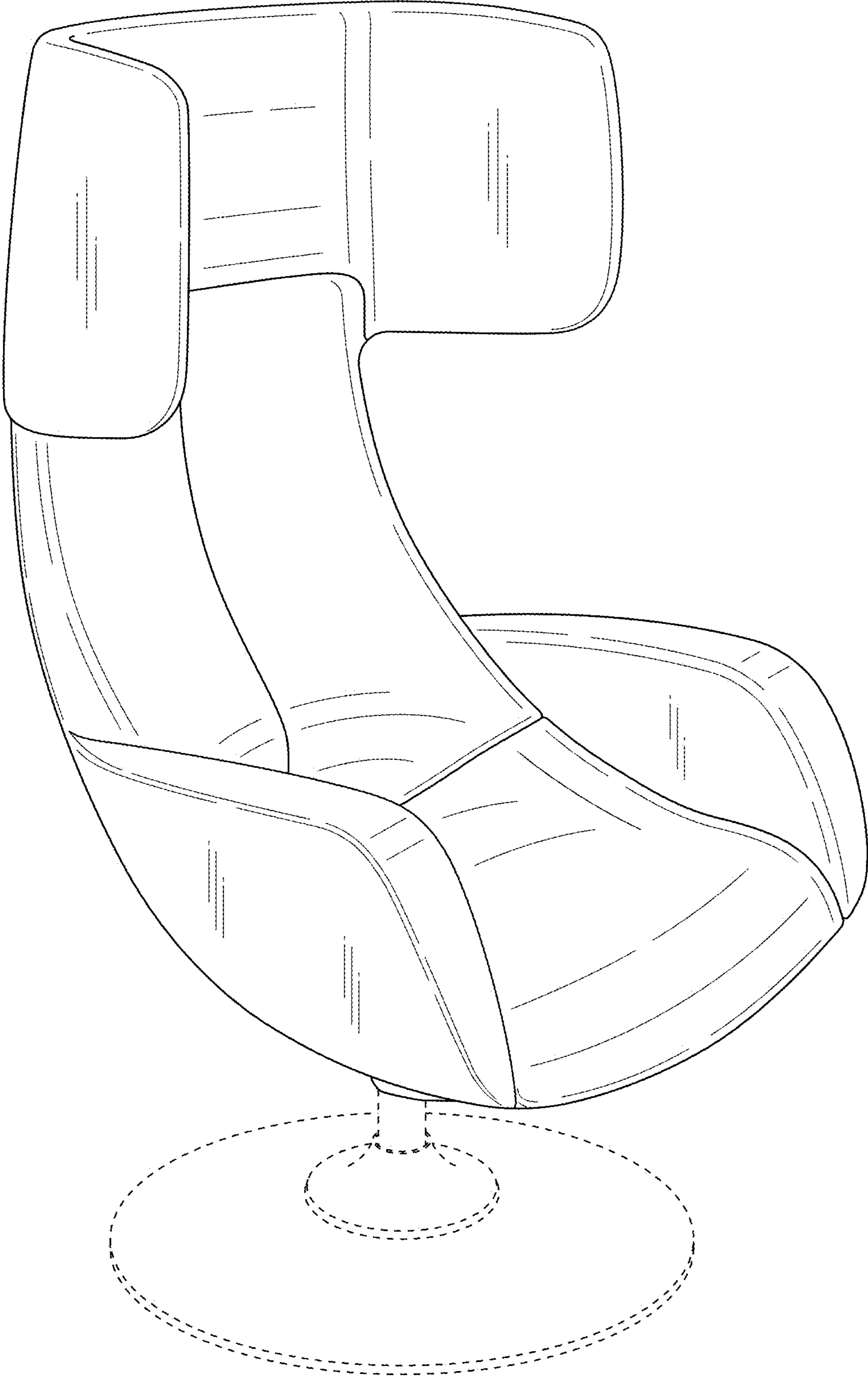

Fig. 2

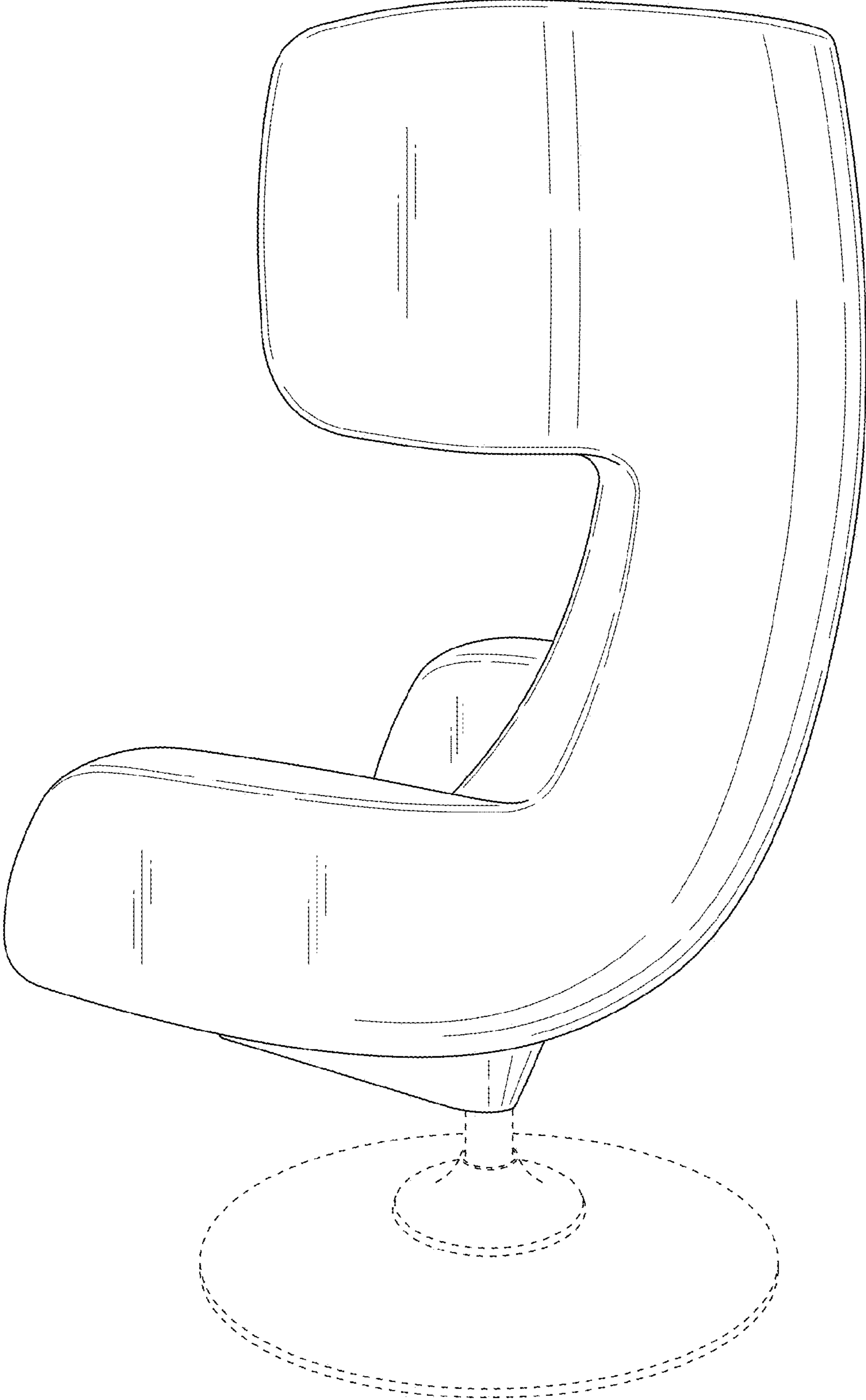

Fig. 3

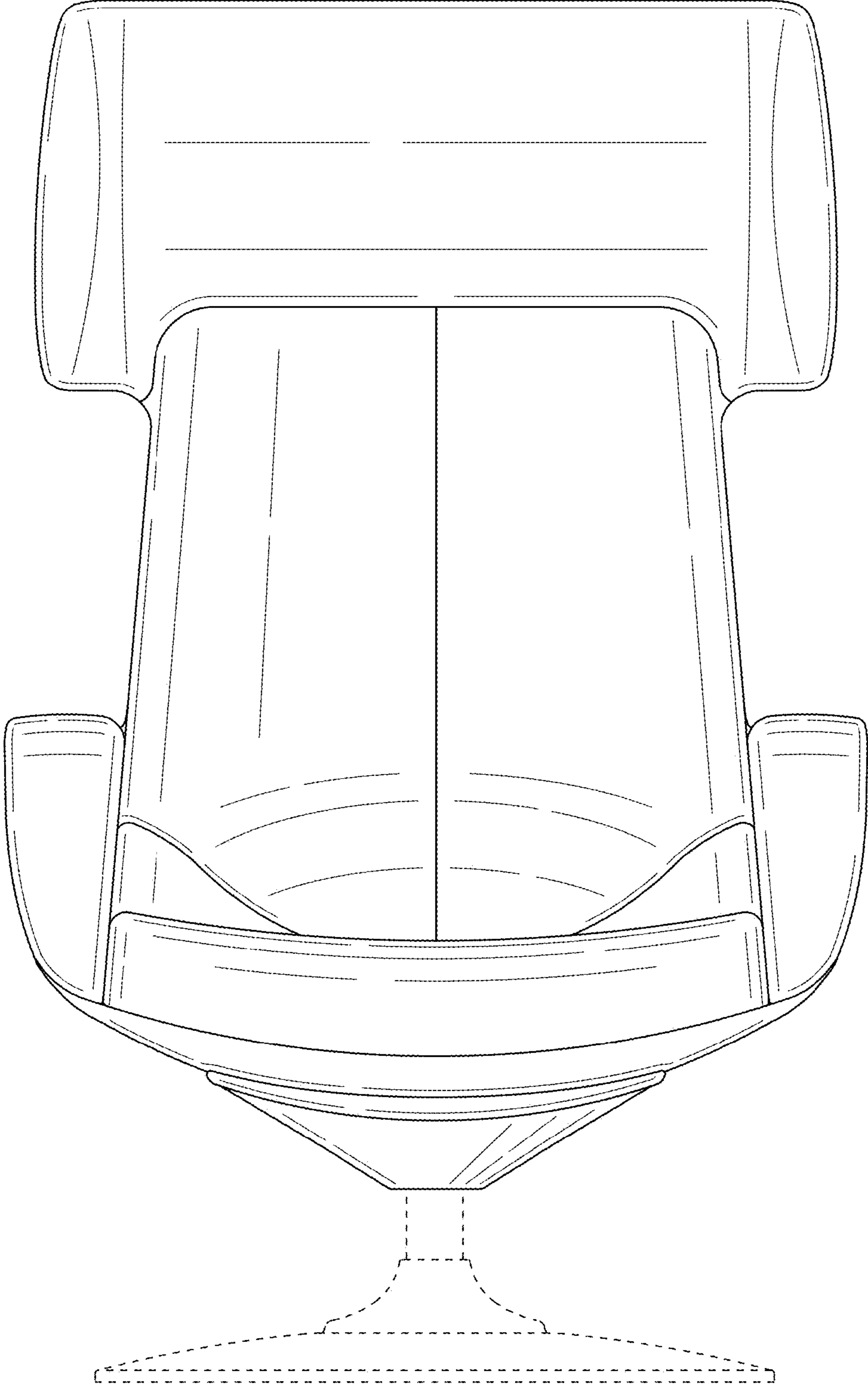

Fig. 4

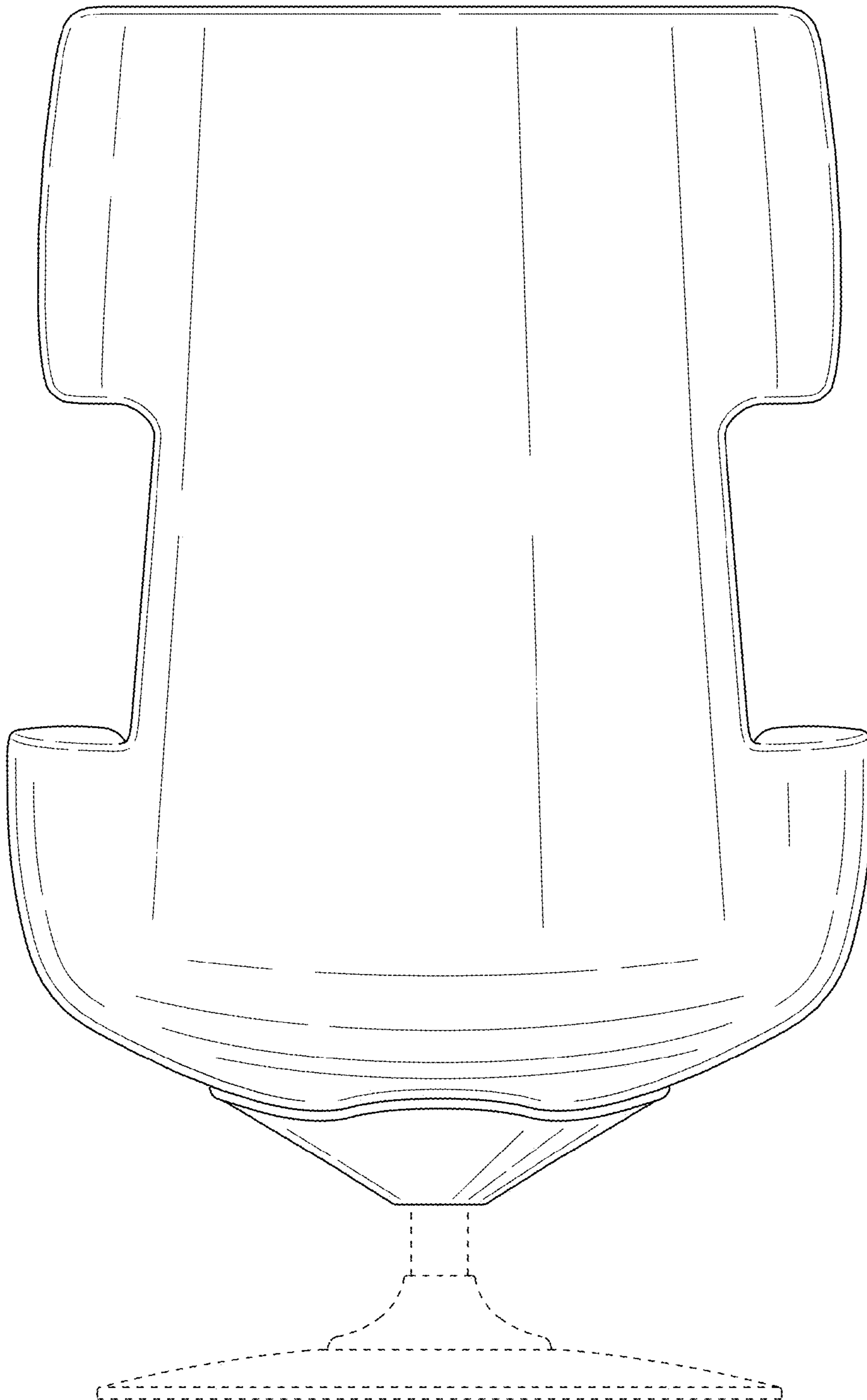

Fig. 5

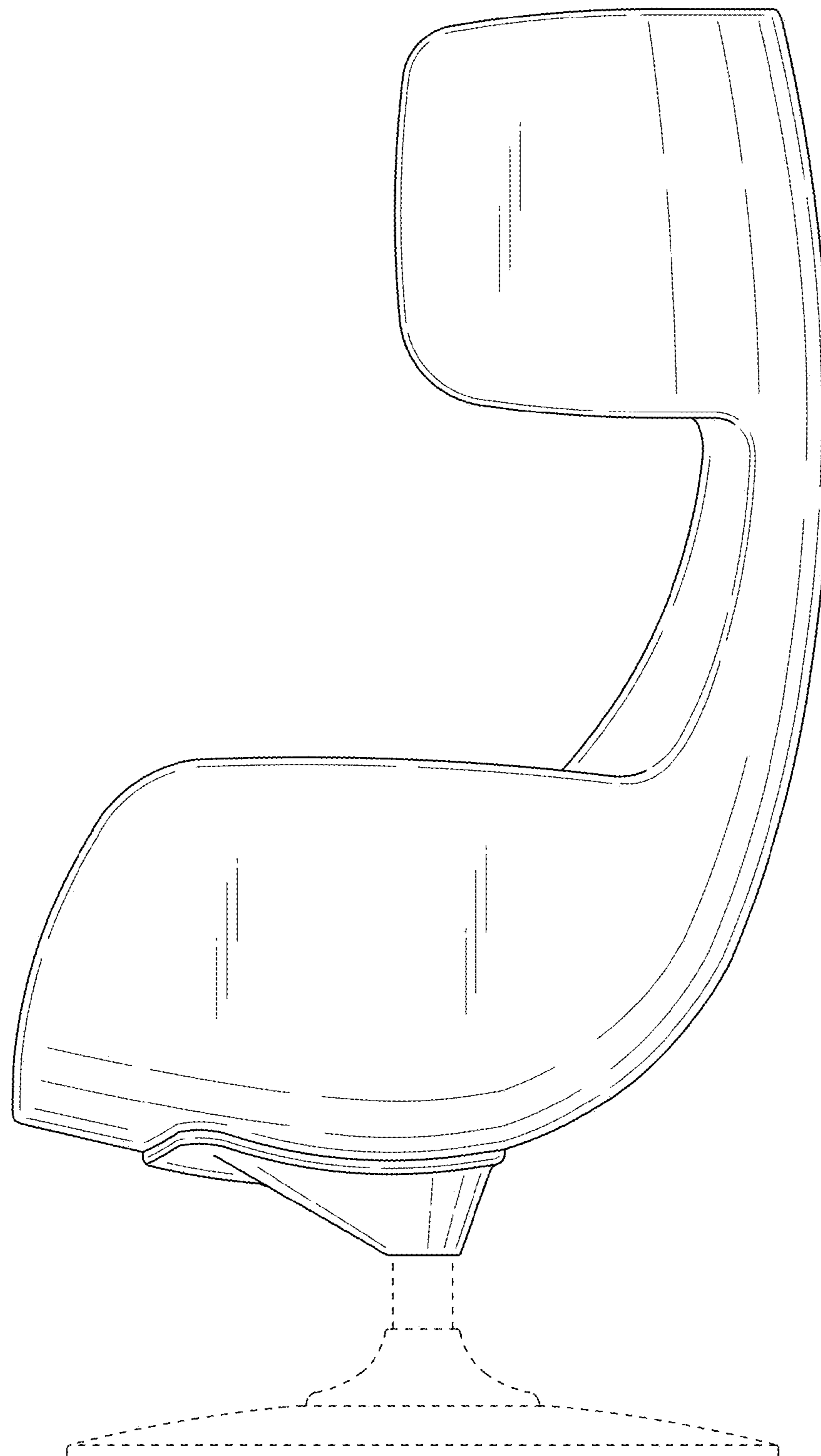

Fig. 6

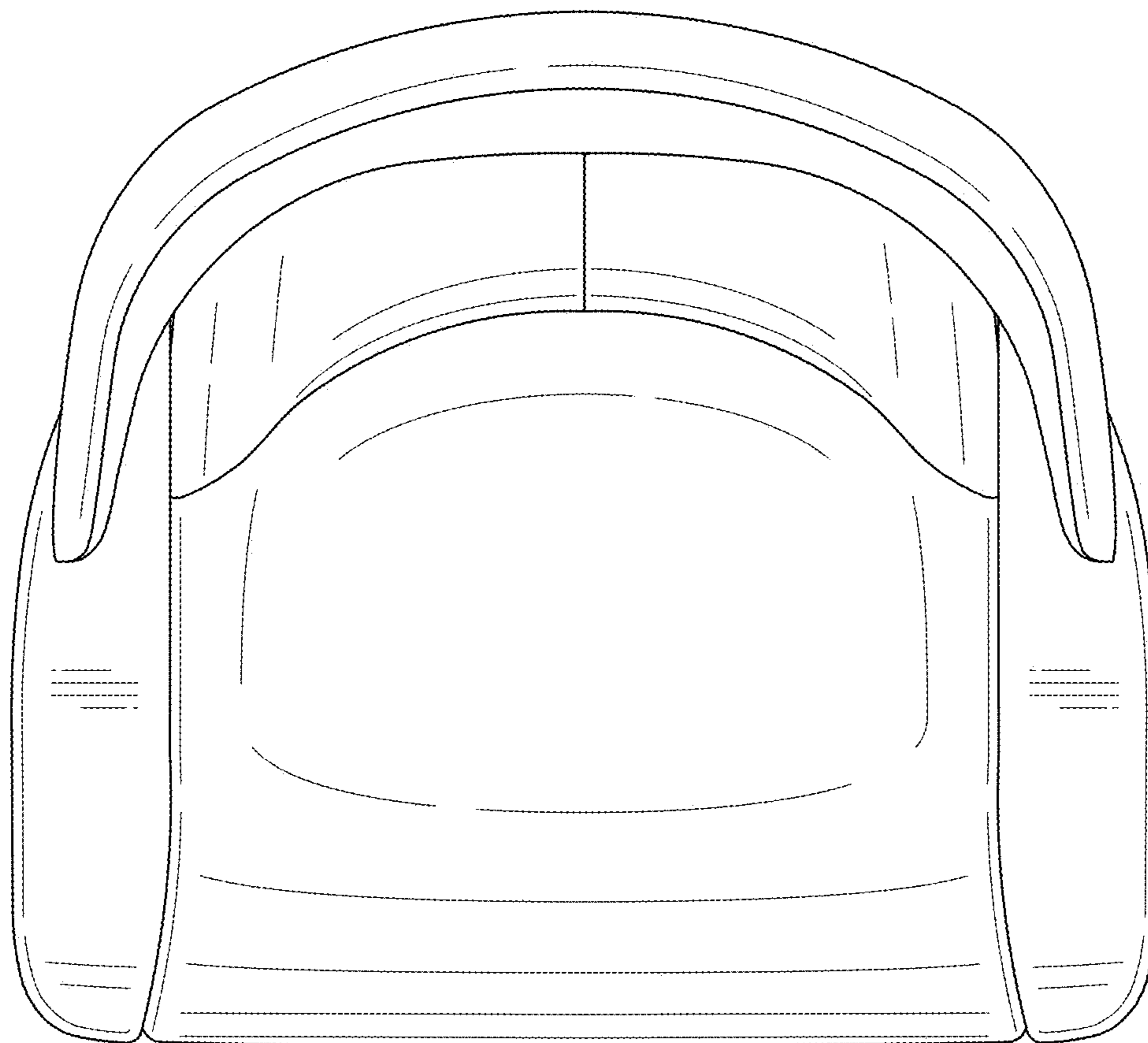

Fig. 7

