



US00D878757S

(12) **United States Design Patent**
Hess et al.

(10) **Patent No.:** **US D878,757 S**
(45) **Date of Patent:** **** Mar. 24, 2020**

- (54) **CONTAINER THAT IS REMOVABLY HOUSED IN A FRAME**
- (71) Applicant: **Can Do Logistics LLC**, Berlin, WI (US)
- (72) Inventors: **Michael C. Hess**, Berlin, WI (US);
Preston M. Hess, Berlin, WI (US)
- (73) Assignee: **Can Do Logistics LLC**, Berlin, WI (US)
- (**) Term: **15 Years**
- (21) Appl. No.: **29/640,372**
- (22) Filed: **Mar. 14, 2018**
- (51) **LOC (12) Cl.** **03-01**
- (52) **U.S. Cl.**
USPC **D3/272; D23/202**
- (58) **Field of Classification Search**
USPC **D3/272, 273, 201, 302; D25/33, 34; D34/38; D23/202**
CPC **B65D 88/26; B65D 88/52; B65D 88/522; B65D 88/528; B65D 88/00; B65D 88/542; B65D 9/12; B65D 11/1873; A47B 47/042**
See application file for complete search history.

8,585,341 B1 * 11/2013 Oren B65G 65/42
414/411
RE46,381 E * 5/2017 Oren D23/202
2006/0277783 A1 * 12/2006 Garton B65D 88/128
34/165

(Continued)

OTHER PUBLICATIONS

Youtube, "The SandCan™ System" uploaded by user LogicHaul Logistics on Jul. 10, 2018. (<https://www.youtube.com/watch?v=-mCuFFHFsaA>) (Year: 2018).*

Primary Examiner — April Rivas

(74) *Attorney, Agent, or Firm* — Christopher M. Scherer; DeWitt LLP

(57) **CLAIM**

The ornamental design for a container that is removably housed in a frame, as shown and described.

DESCRIPTION

FIG. 1 is a top front perspective view of a container that is removably housed in a frame showing my new design;
 FIG. 2 is a right side view thereof;
 FIG. 3 is a left side view thereof;
 FIG. 4 is a front side view thereof;
 FIG. 5 is a back side view thereof;
 FIG. 6 is a top side view thereof;
 FIG. 7 is a bottom side view thereof;
 FIG. 8 is a top front perspective view of an alternate embodiment of the container that is removably housed in a frame;
 FIG. 9 is a right side view thereof;
 FIG. 10 is a left side view thereof;
 FIG. 11 is a front side view thereof;
 FIG. 12 is a back side view thereof;
 FIG. 13 is a top side view thereof; and,
 FIG. 14 is a bottom side view thereof.

1 Claim, 14 Drawing Sheets

(56) **References Cited**

U.S. PATENT DOCUMENTS

- D216,511 S * 1/1970 Coleman D23/202
- 4,138,163 A * 2/1979 Calvert B65D 88/128
220/1.5
- D286,172 S * 10/1986 Takino D23/202
- D295,102 S * 4/1988 Erickson D34/28
- D415,869 S * 10/1999 Roodvoets D34/38
- D544,675 S * 6/2007 Ishikawa D34/38
- D603,123 S * 10/2009 Canters D34/38
- D688,351 S * 8/2013 Oren B65D 88/30
D23/202
- 8,505,780 B2 * 8/2013 Oren B65D 88/32
222/185.1

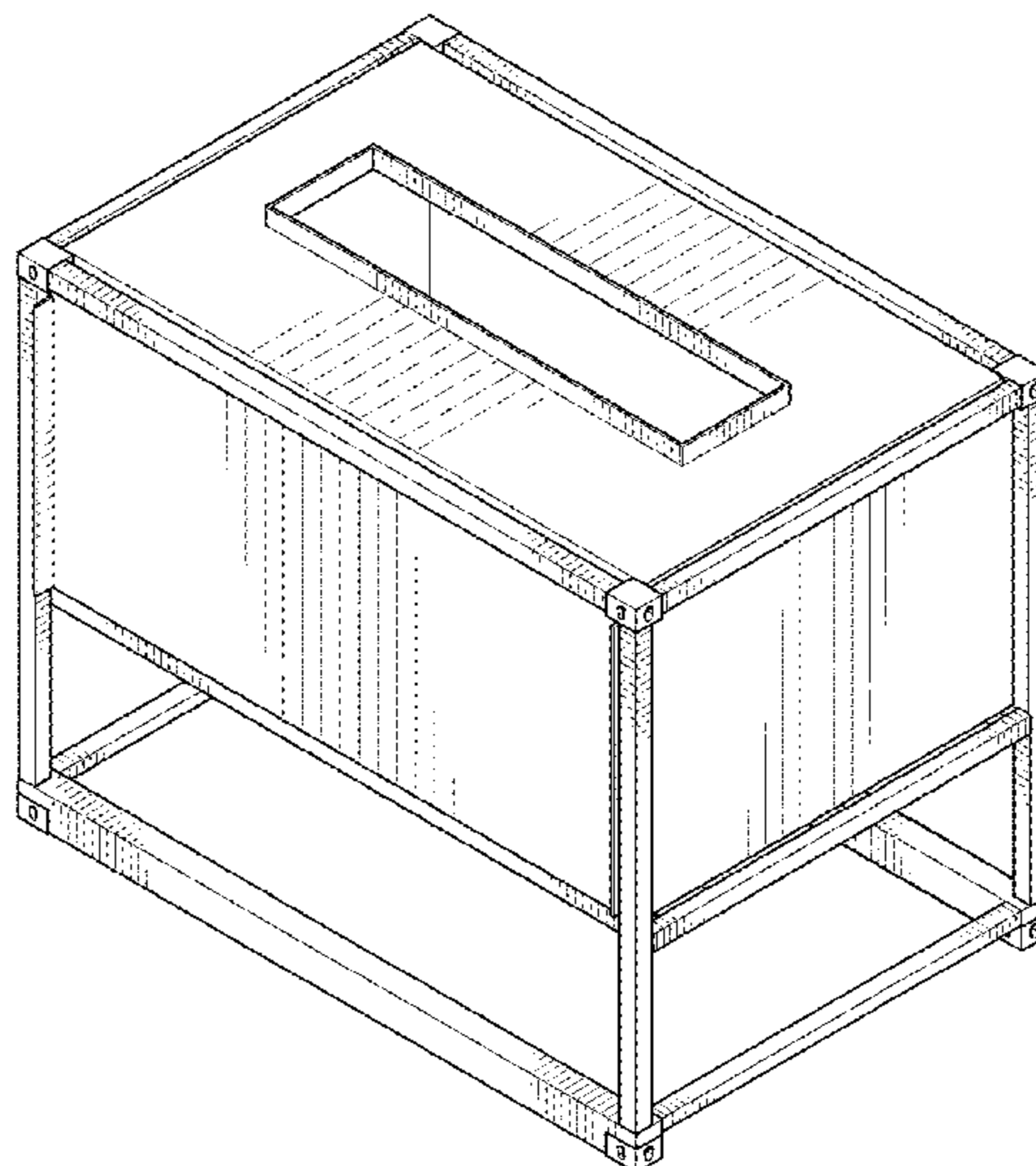

(56)

References Cited

U.S. PATENT DOCUMENTS

2014/0083554 A1* 3/2014 Harris B65D 88/32
141/1
2014/0203046 A1* 7/2014 Allegretti B65G 65/40
222/185.1
2017/0320660 A1* 11/2017 Sanders B65D 88/022
2018/0093823 A1* 4/2018 Hess B65D 90/587
2018/0201437 A1* 7/2018 Surjaatmadja B65D 88/26

* cited by examiner

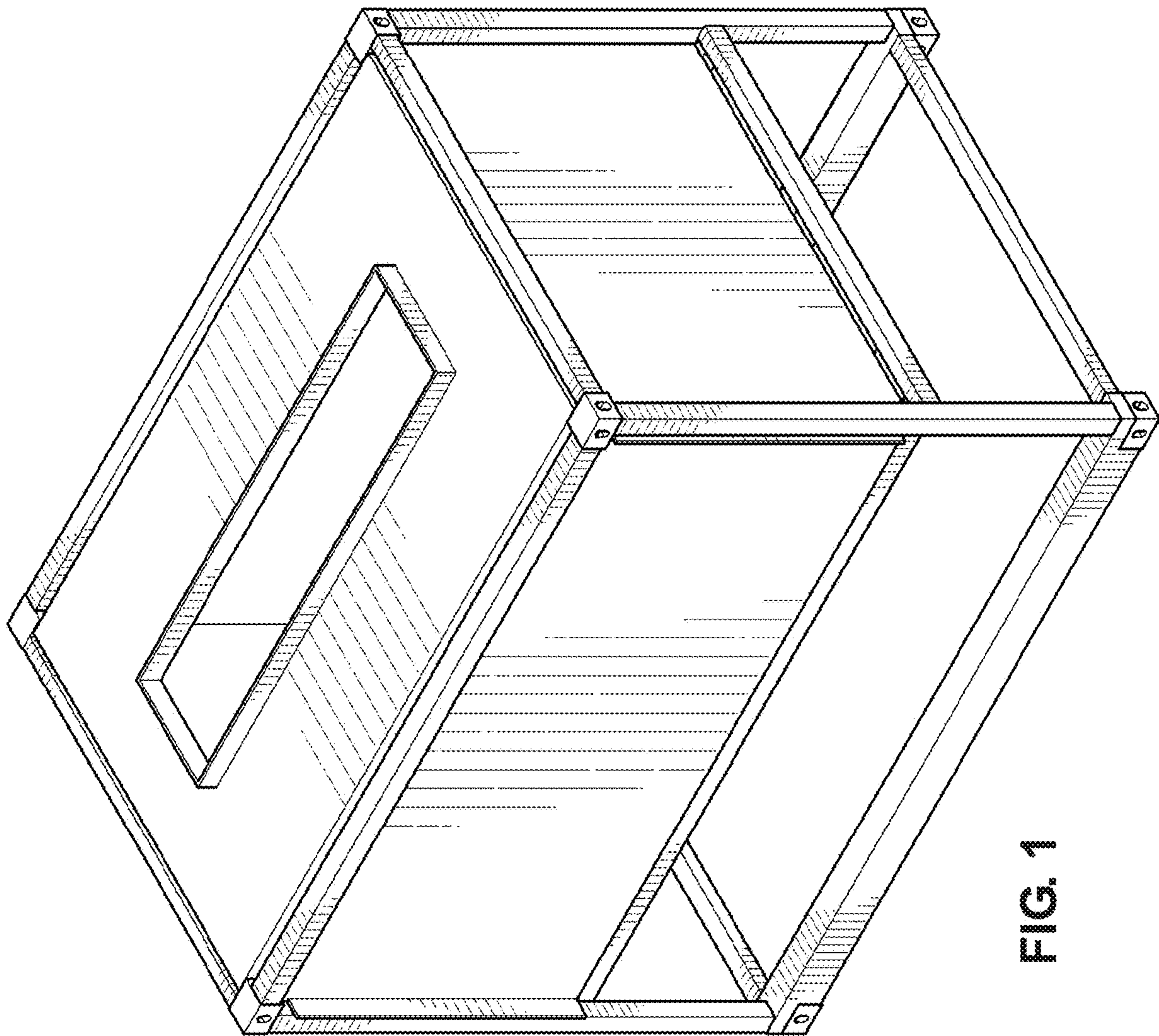

FIG. 1

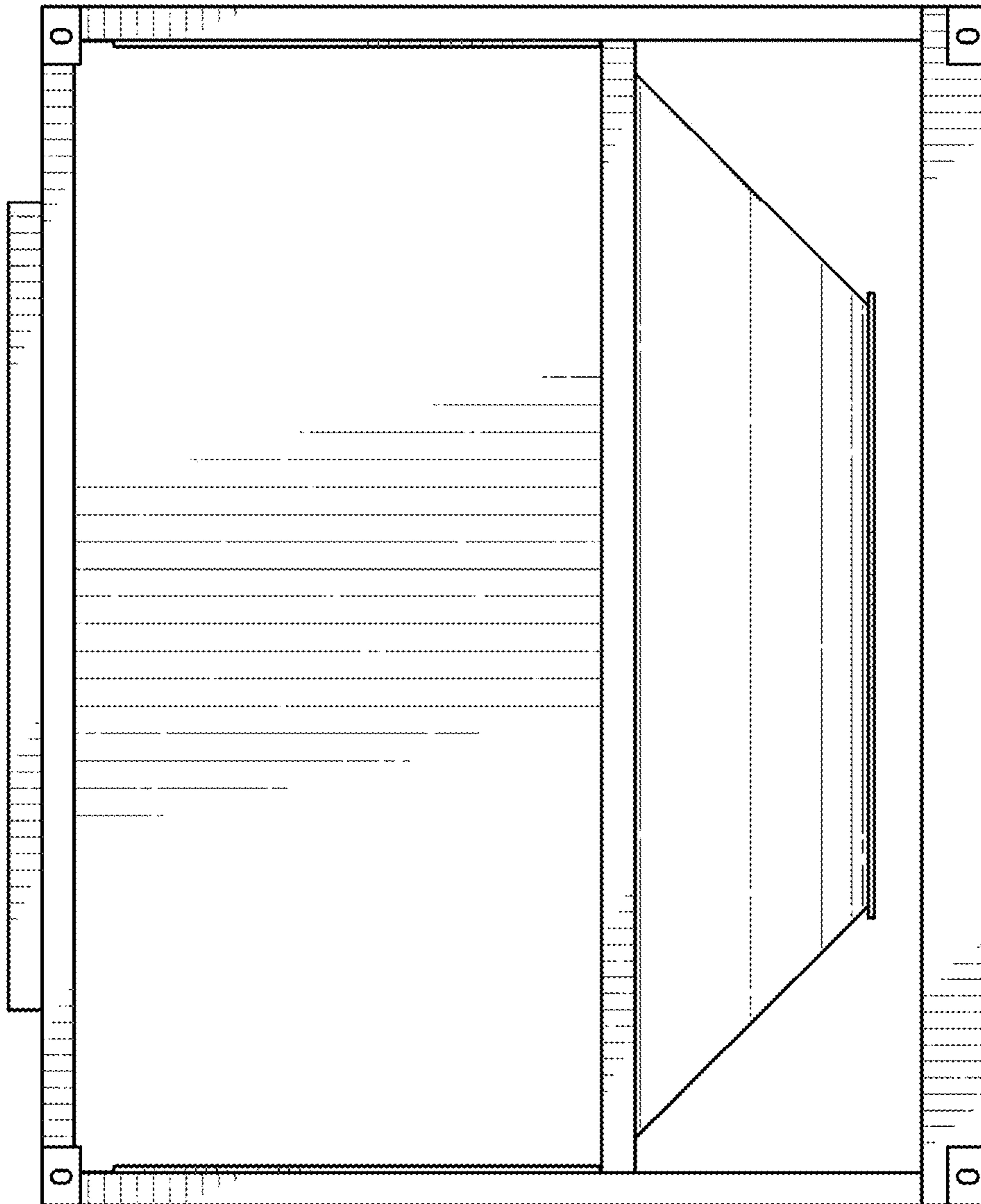

FIG. 2

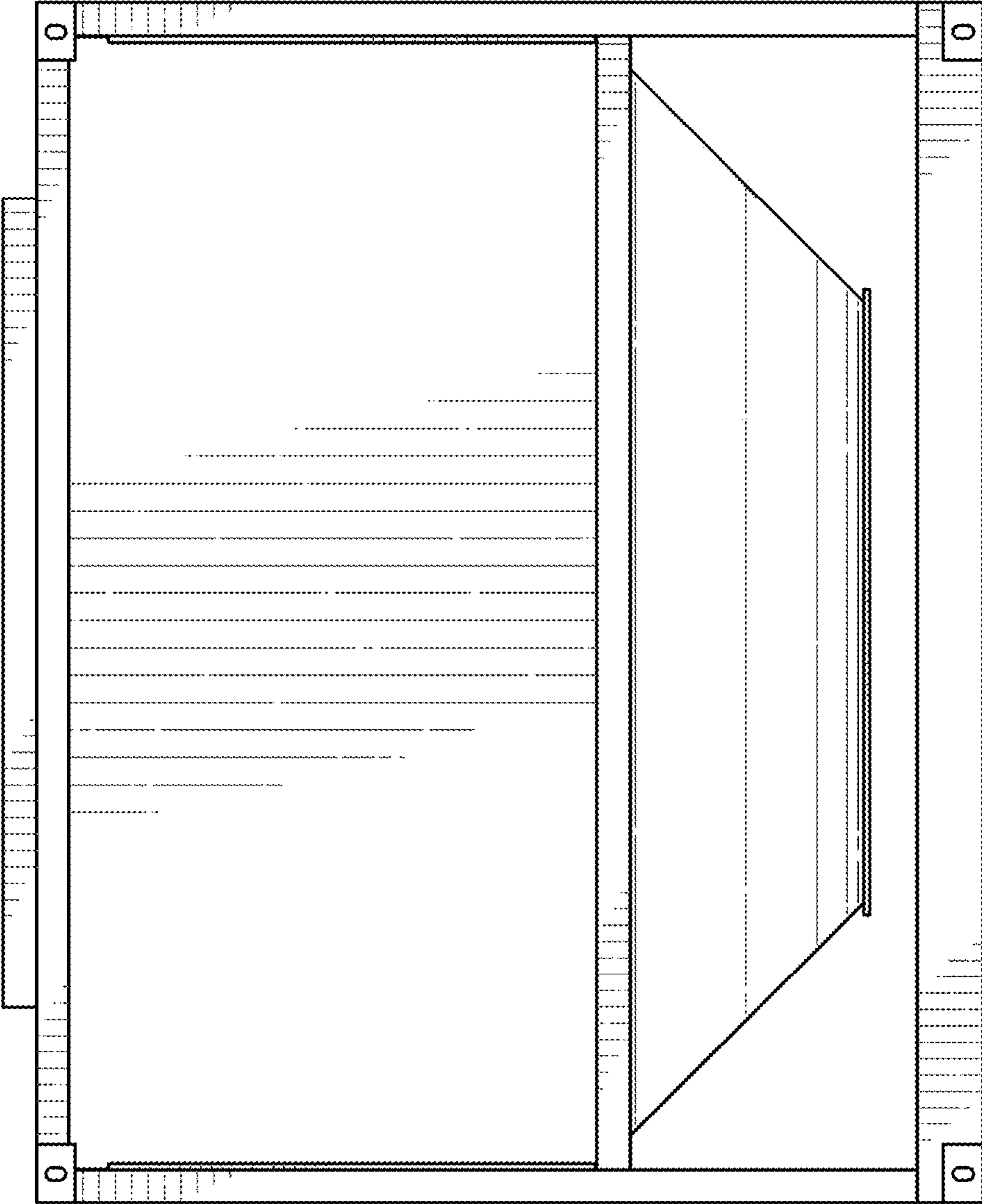

FIG. 3

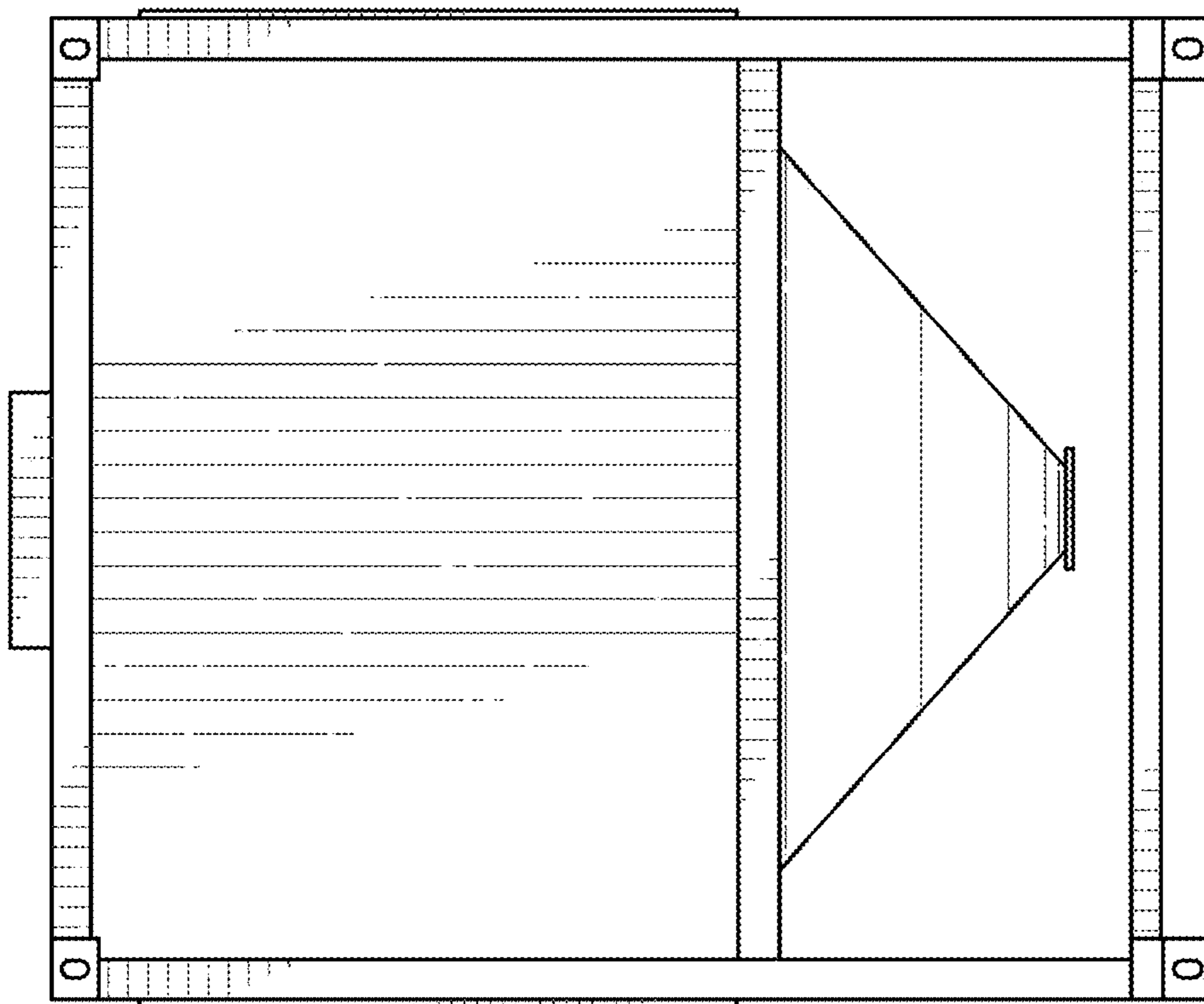

FIG. 4

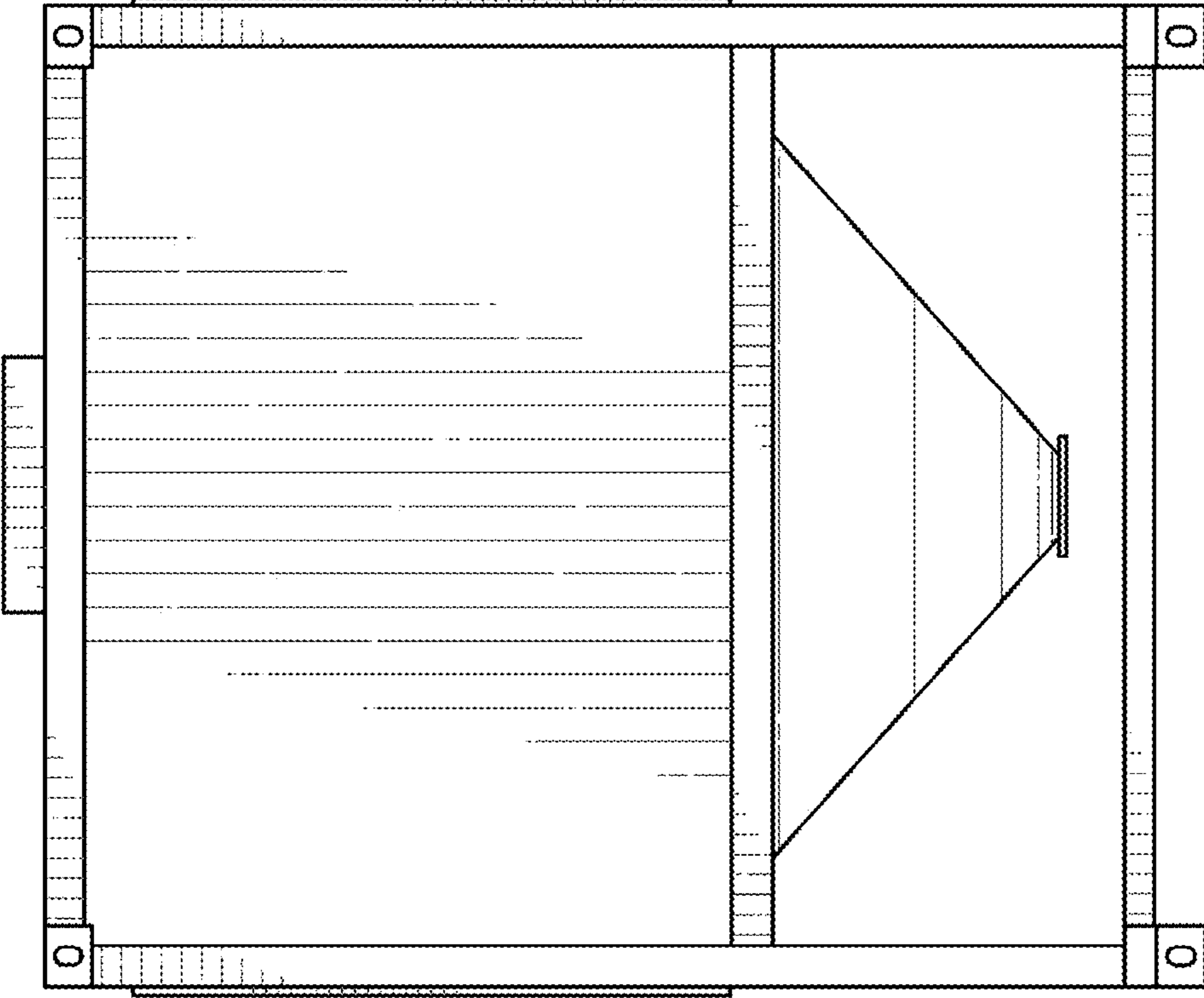

FIG. 5

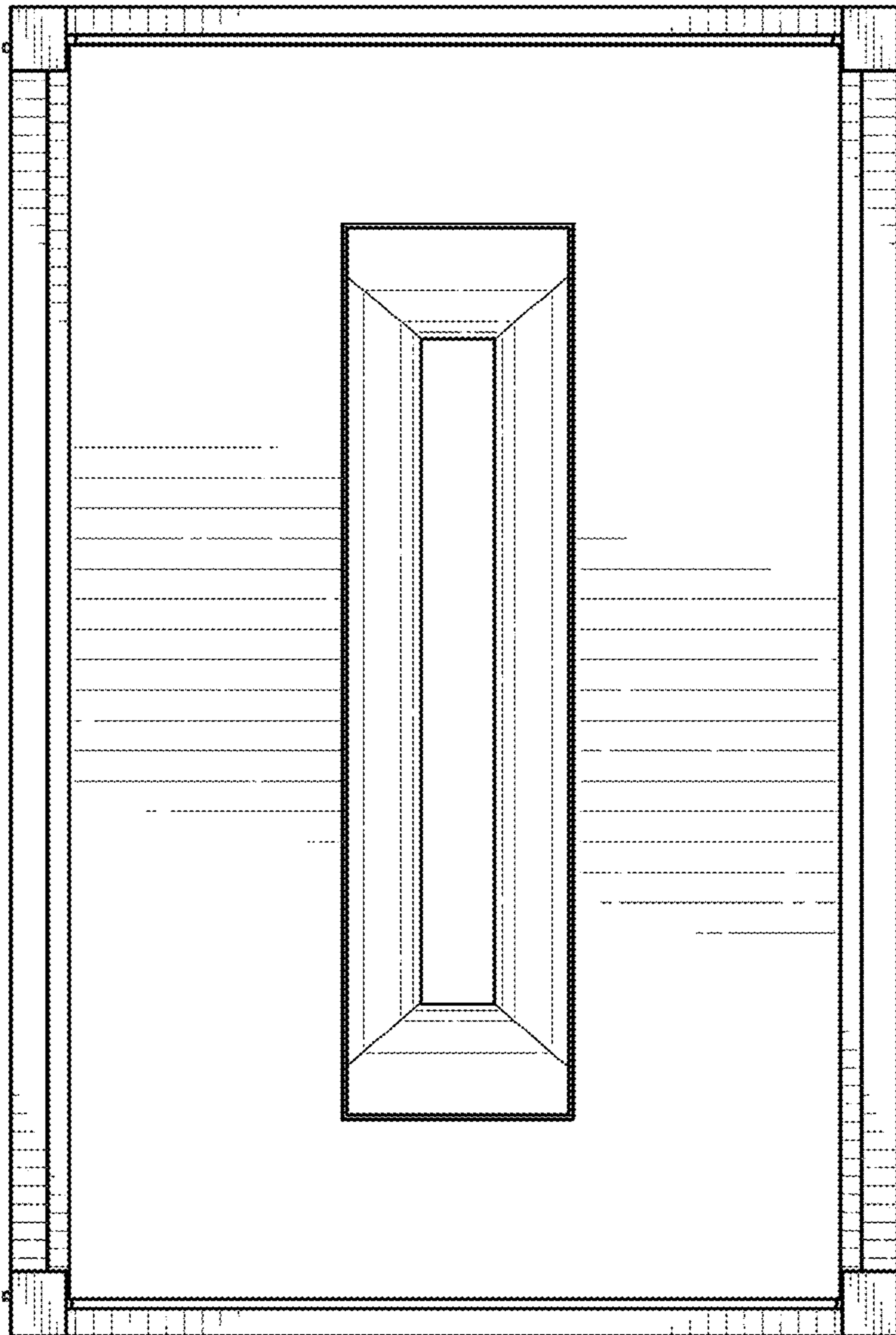

FIG. 6

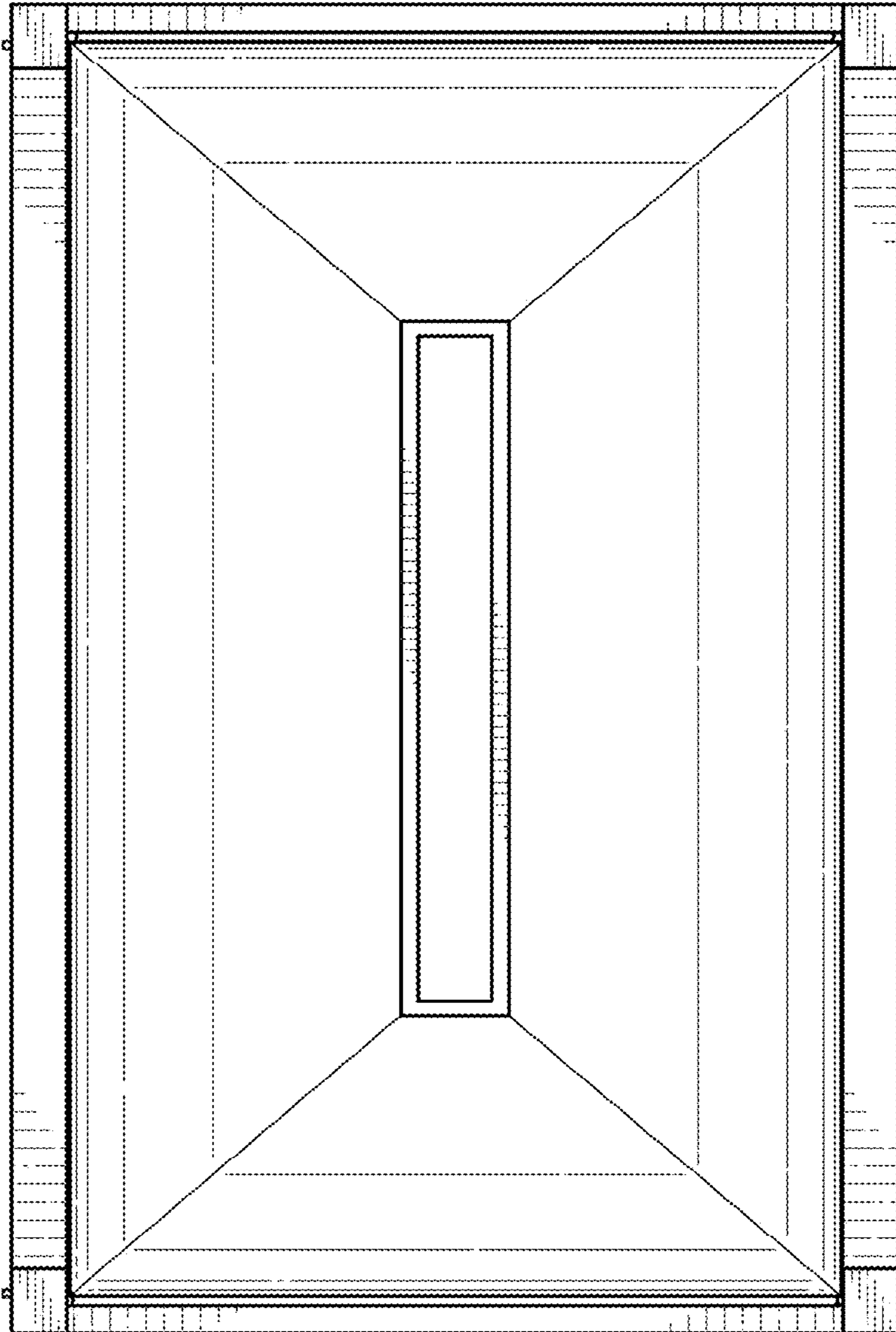

FIG. 7

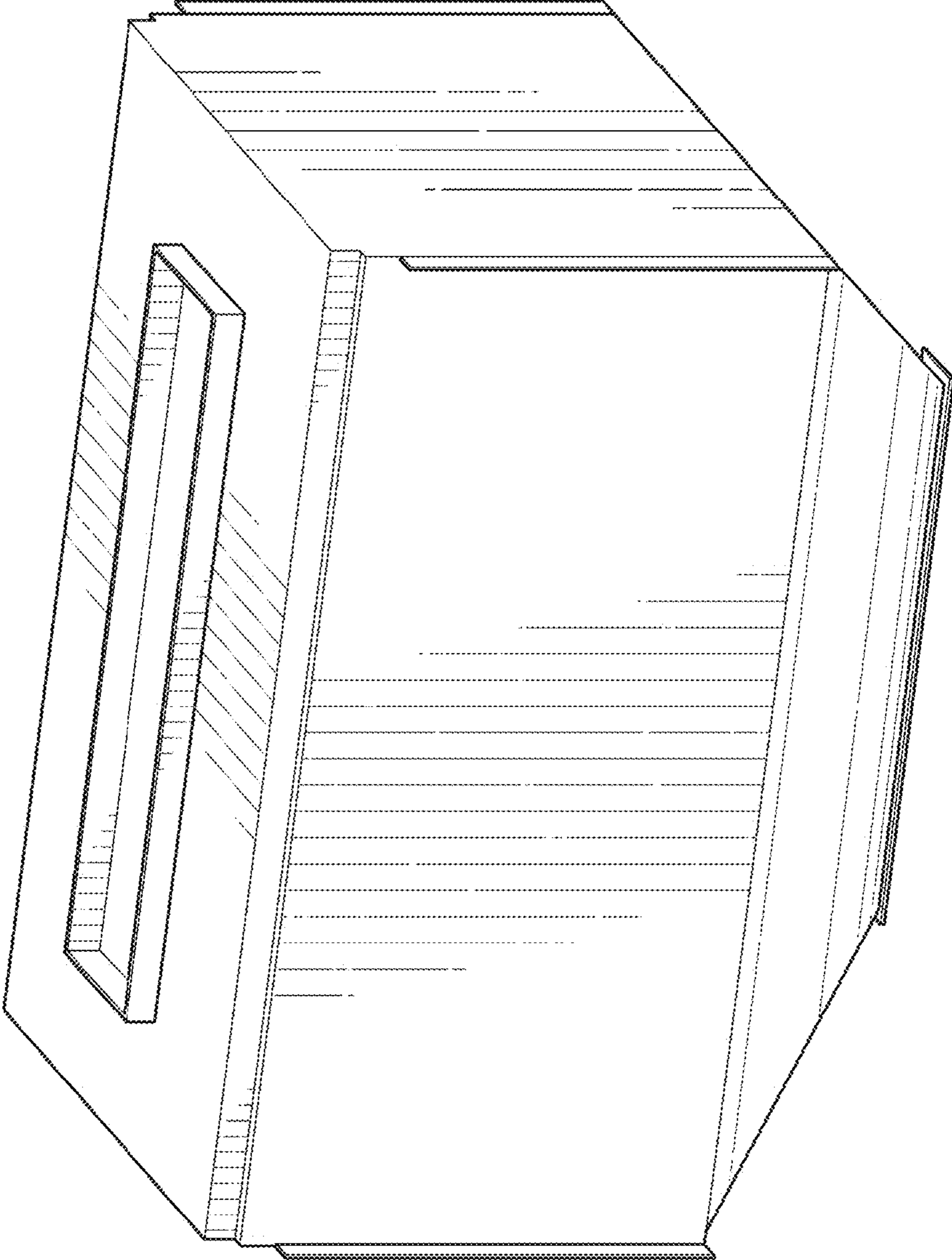

FIG. 8

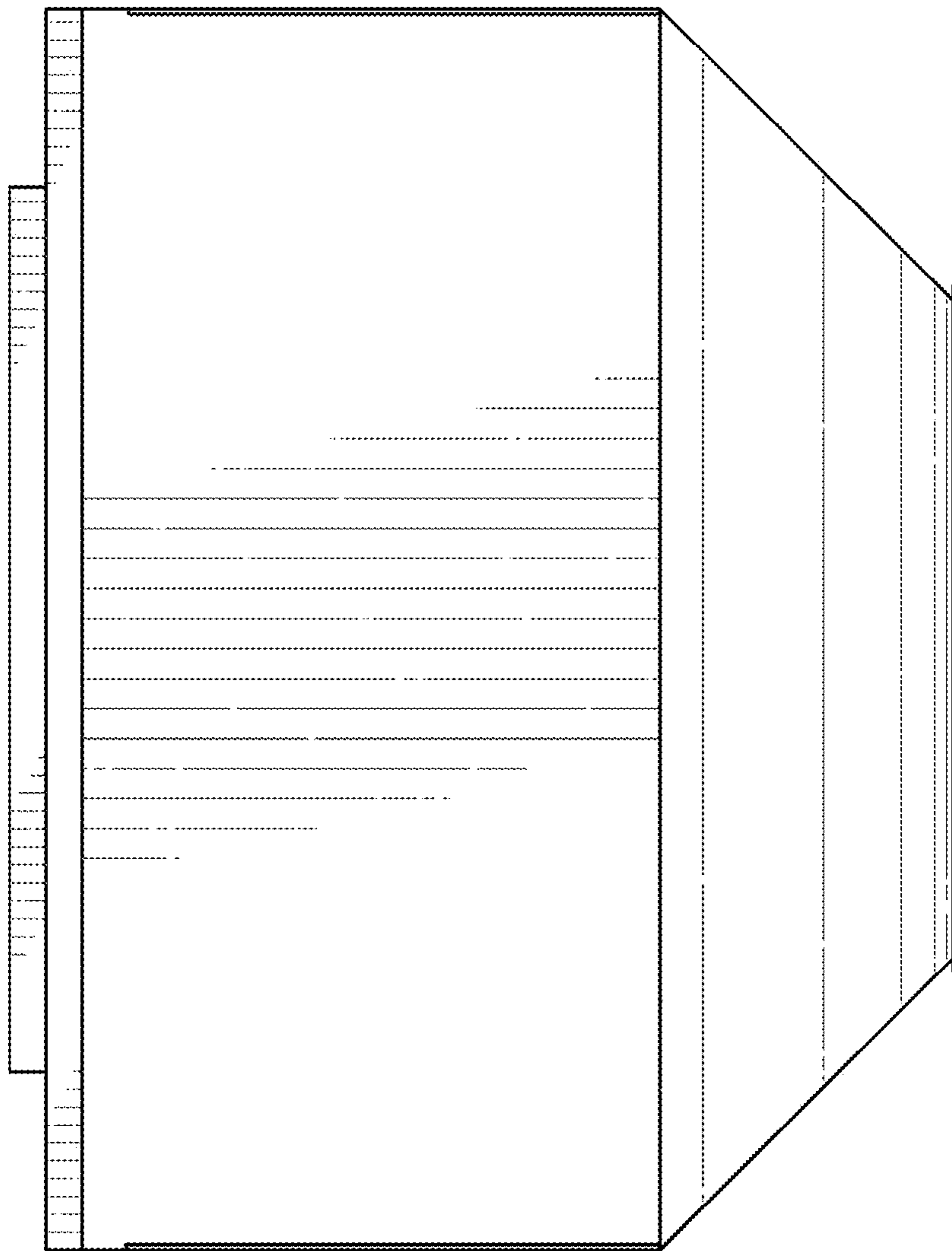

FIG. 9

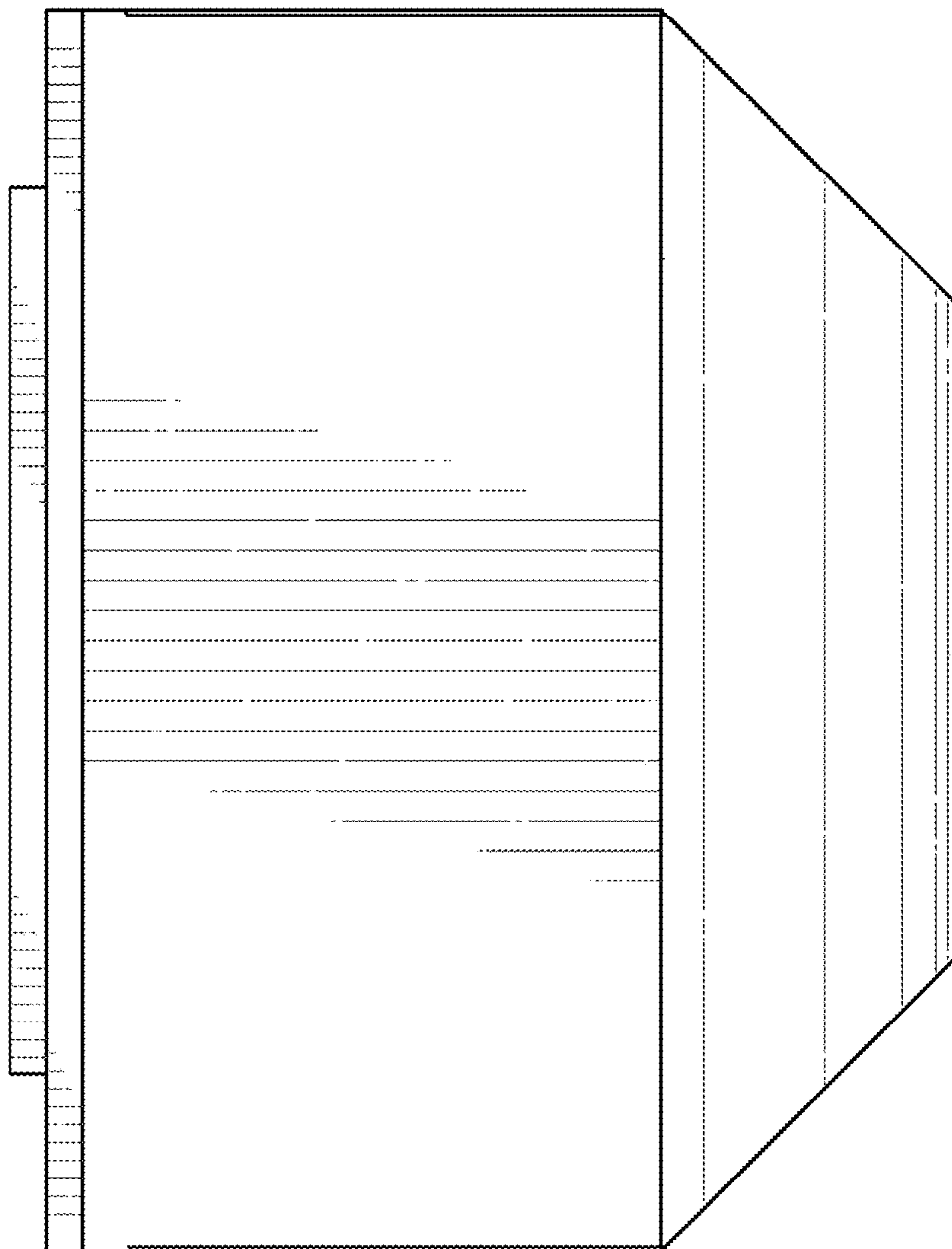

FIG. 10

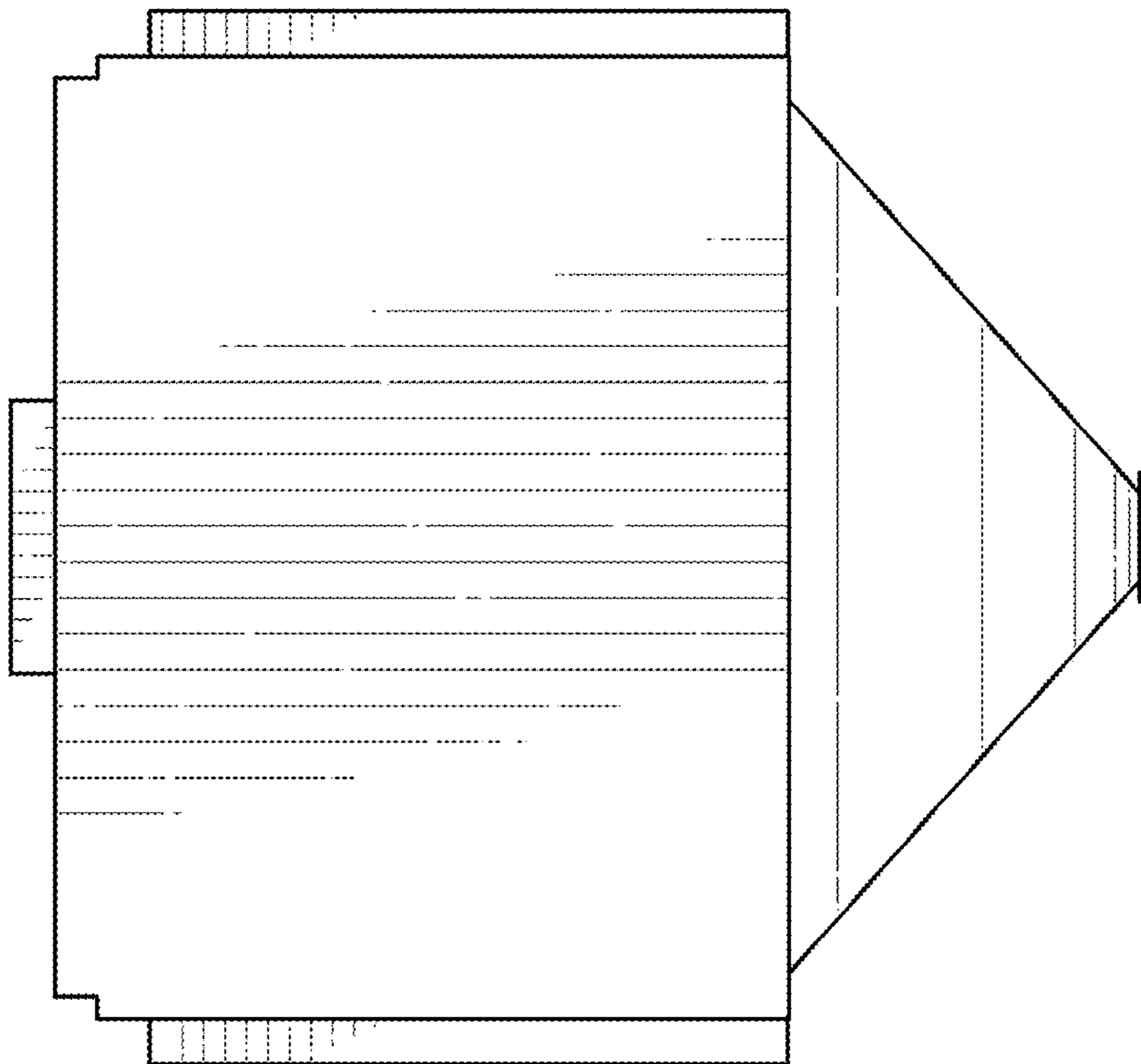

FIG. 11

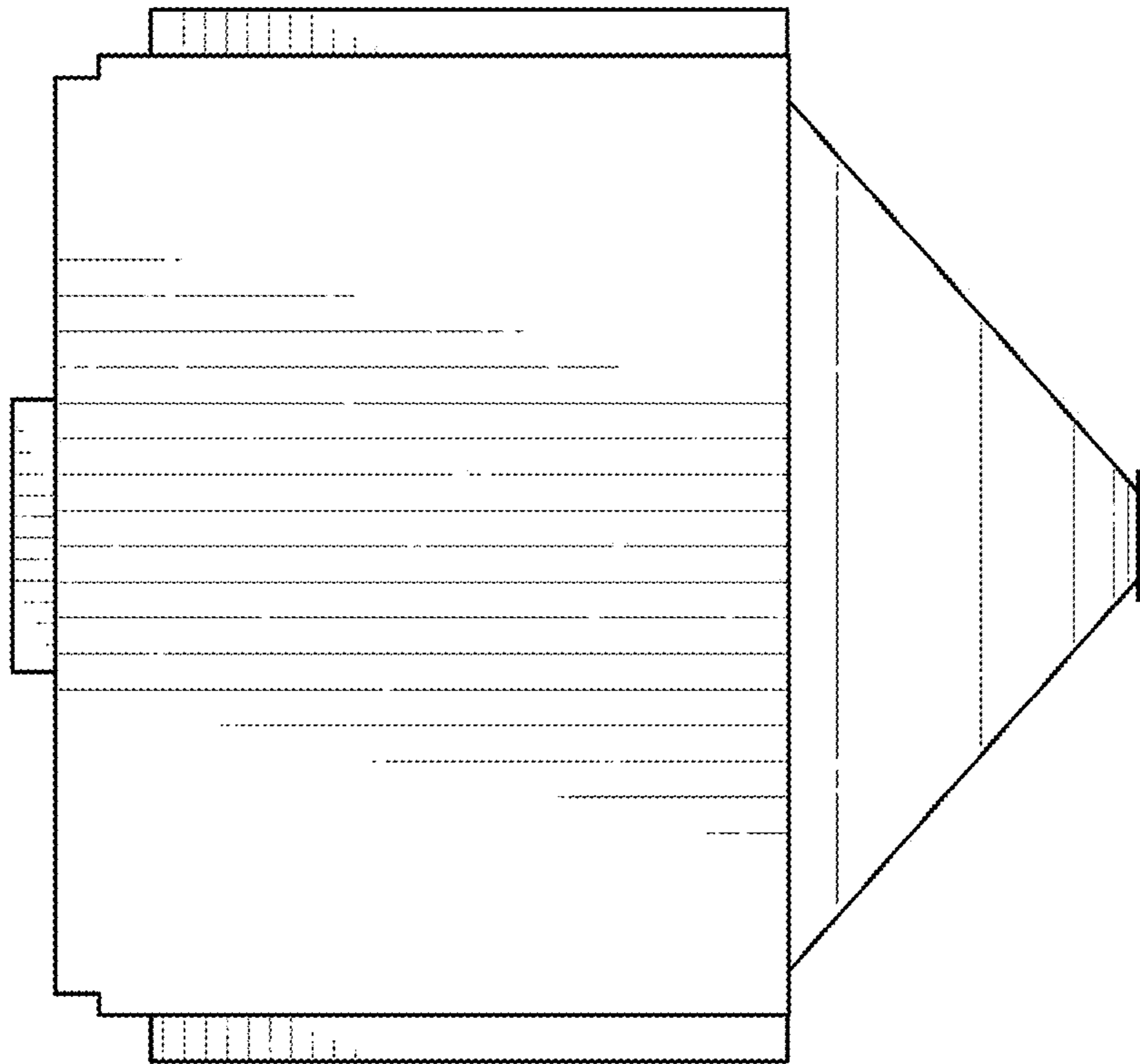

FIG. 12

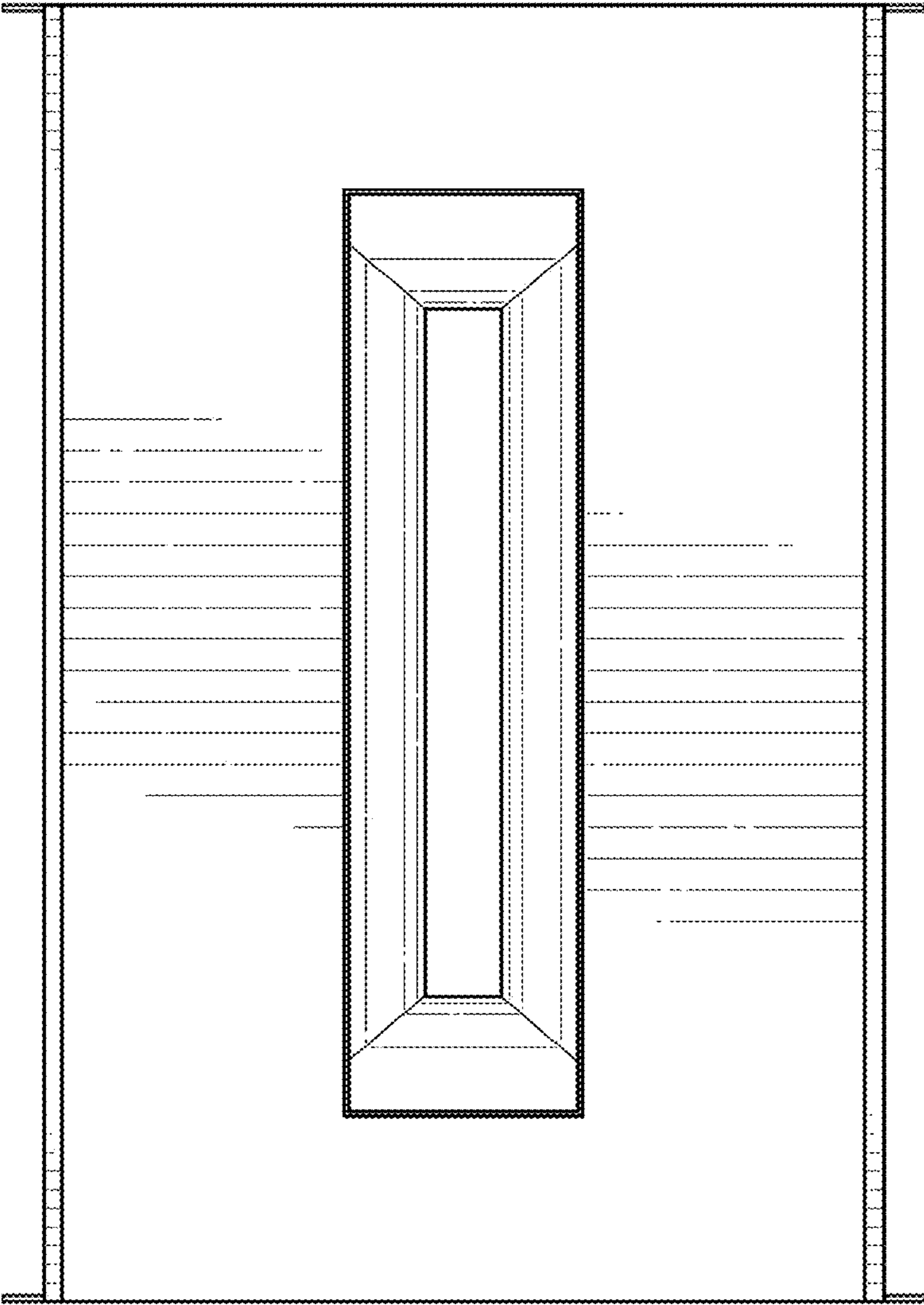

FIG. 13

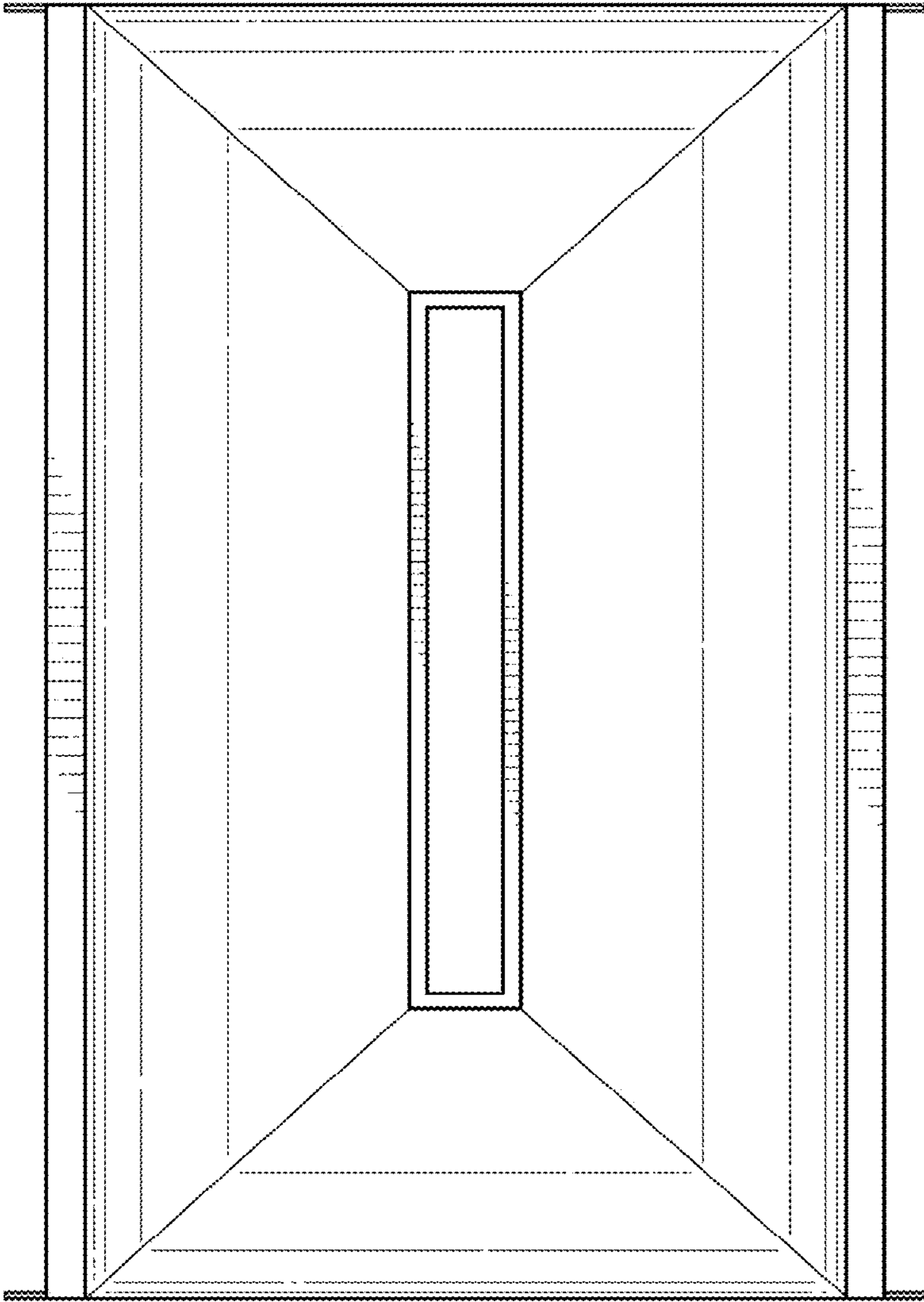

FIG. 14