



US00D878748S

(12) **United States Design Patent**  
**Fumagalli**

(10) **Patent No.:** **US D878,748 S**

(45) **Date of Patent:** **\*\* Mar. 24, 2020**

- (54) **BAG**
- (71) Applicant: **PELLETTERIE BIANCHI E NARDI S.P.A.**, Scandicci (FI) (IT)
- (72) Inventor: **Alessandro Fumagalli**, Milan (IT)
- (73) Assignee: **Pelletterie Bianchi e Nardi S.P.A.**, Scandicci (FI) (IT)

D702,042 S \* 4/2014 Holloway ..... D3/243  
 D813,532 S \* 3/2018 Yuson ..... D3/243  
 D820,588 S \* 6/2018 Nair ..... D3/243

\* cited by examiner

- (\*\*) Term: **15 Years**
- (21) Appl. No.: **29/659,447**
- (22) Filed: **Aug. 9, 2018**

*Primary Examiner* — Holly H Baynham  
 (74) *Attorney, Agent, or Firm* — Nancy J. Flint, Attorney At Law, P.A.; Nancy J. Flint, Esq.

- (30) **Foreign Application Priority Data**  
 Jul. 20, 2018 (EM) ..... 005509684
- (51) **LOC (12) Cl.** ..... **03-01**
- (52) **U.S. Cl.**  
 USPC ..... **D3/243**
- (58) **Field of Classification Search**  
 USPC ..... D3/232–233, 240–243, 245–246  
 CPC ..... A45C 1/024; A45C 3/06  
 See application file for complete search history.

(57) **CLAIM**  
 The ornamental design for a bag, as shown and described.

**DESCRIPTION**

FIG. 1 is a front perspective view of a bag showing my new design;  
 FIG. 2 is a rear perspective view of the bag;  
 FIG. 3 is a front view of the bag;  
 FIG. 4 is a rear view of the bag;  
 FIG. 5 is a left side view of the bag;  
 FIG. 6 is a top view of the bag;  
 FIG. 7 is a bottom view of the bag; and,  
 FIG. 8 is a cross-sectional view of the bag along the line 8-8 of FIG. 6.  
 The evenly spaced broken lines showing the container are for the purposes of illustrating environment. The dot-dashed lines illustrate the boundaries of the claim. Neither of the broken lines are part of the claimed design.

- (56) **References Cited**  
**U.S. PATENT DOCUMENTS**  
 D260,053 S \* 8/1981 Siegel ..... D3/243  
 D640,467 S \* 6/2011 Gerbi ..... D3/243

**1 Claim, 7 Drawing Sheets**

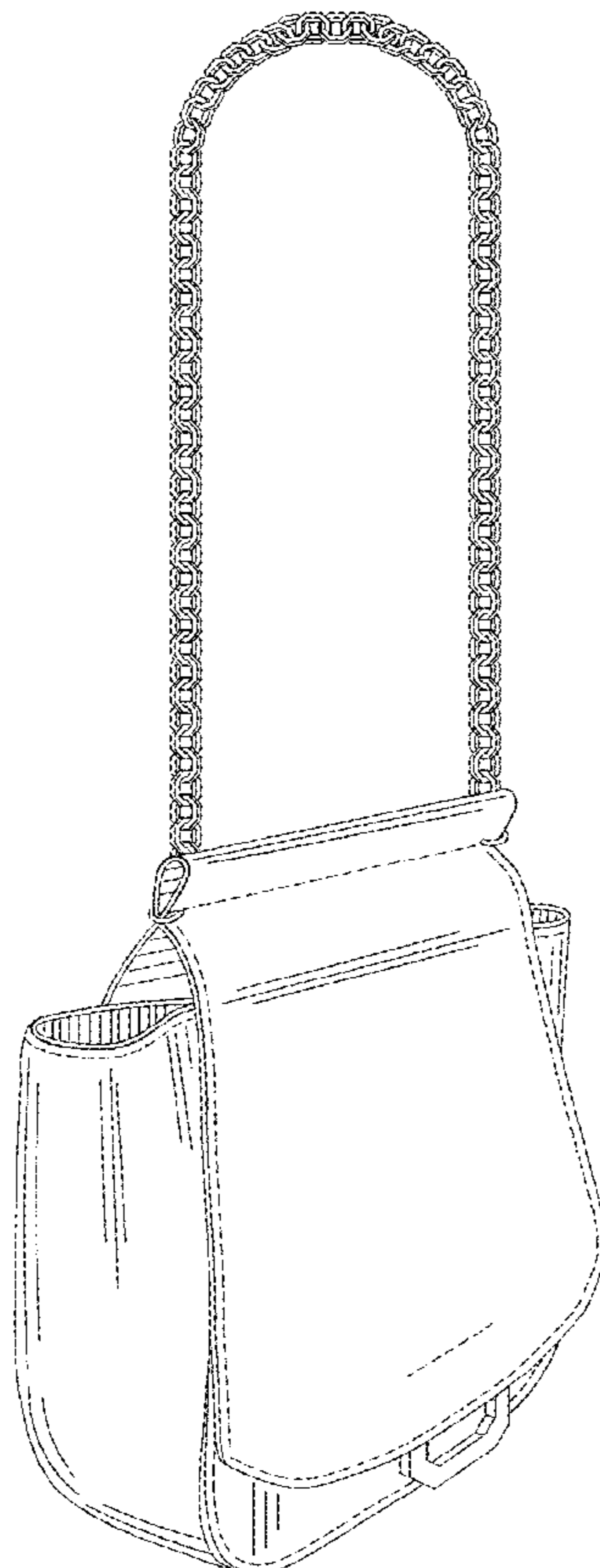

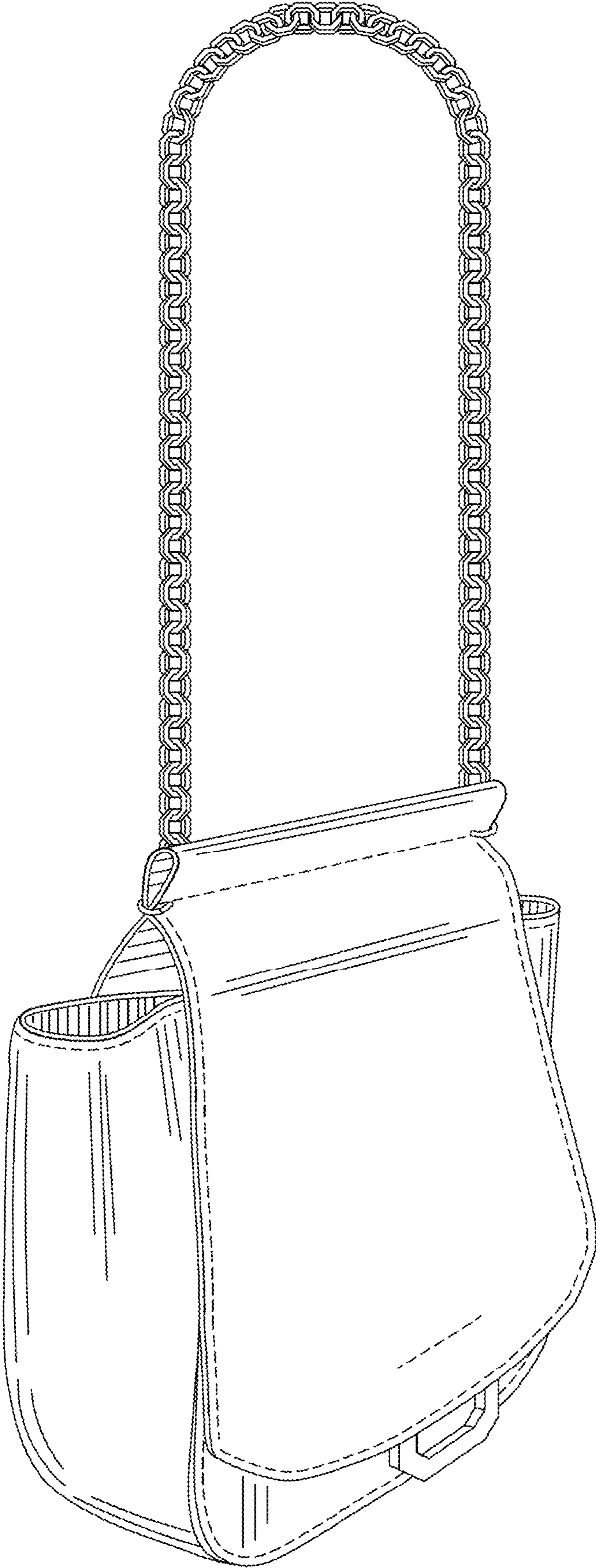

FIG. 1

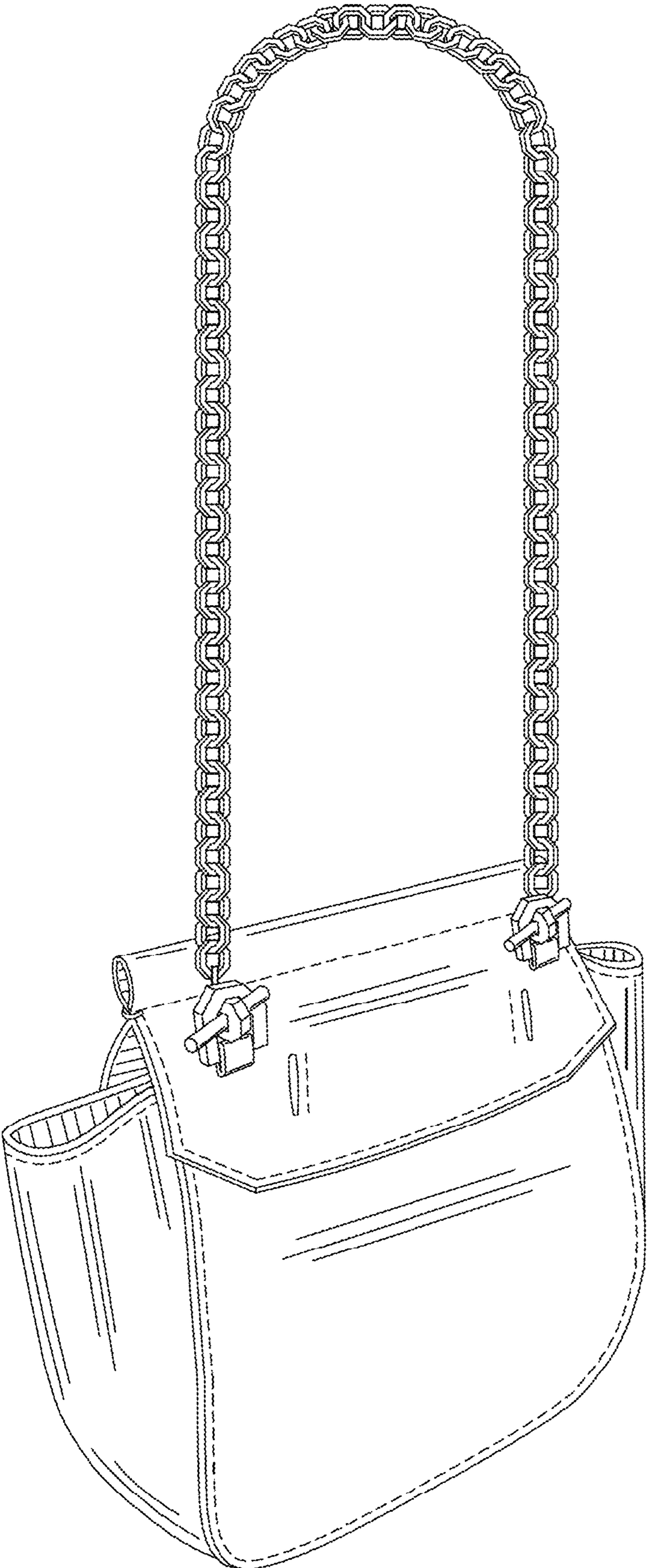

FIG. 2

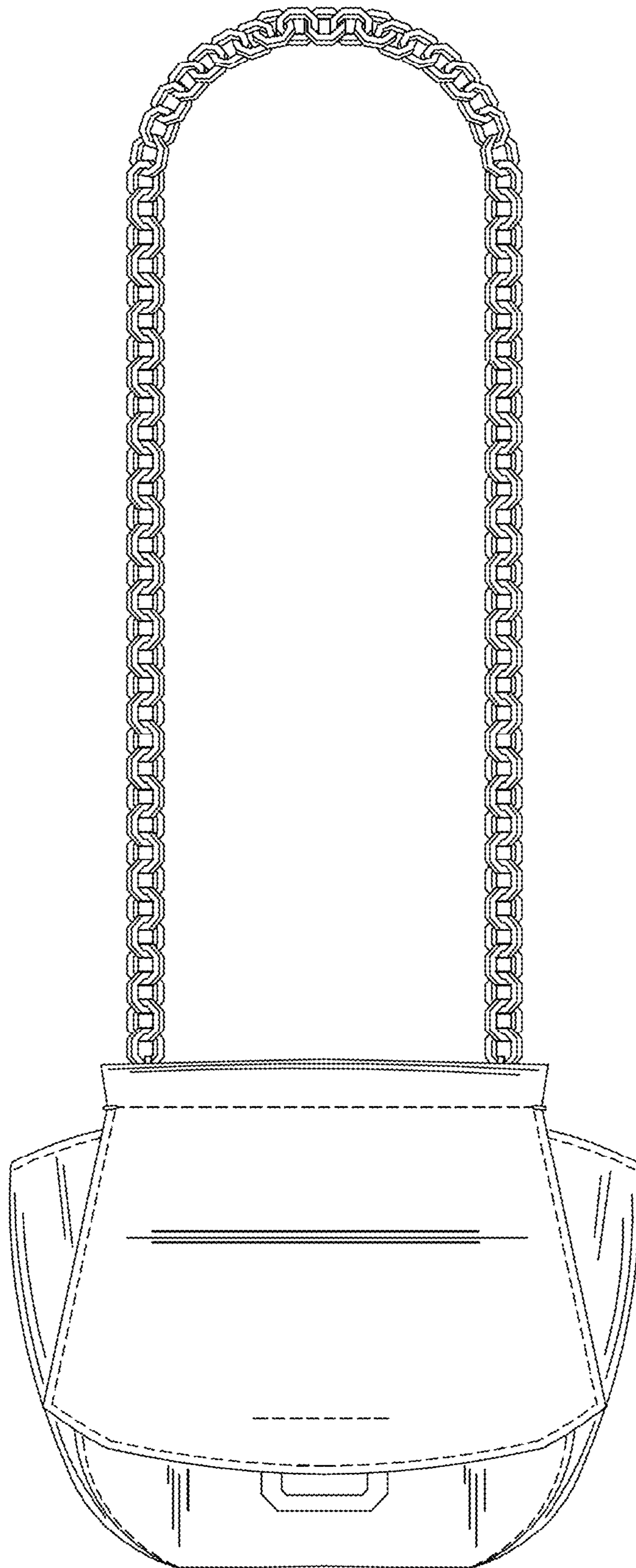

FIG. 3

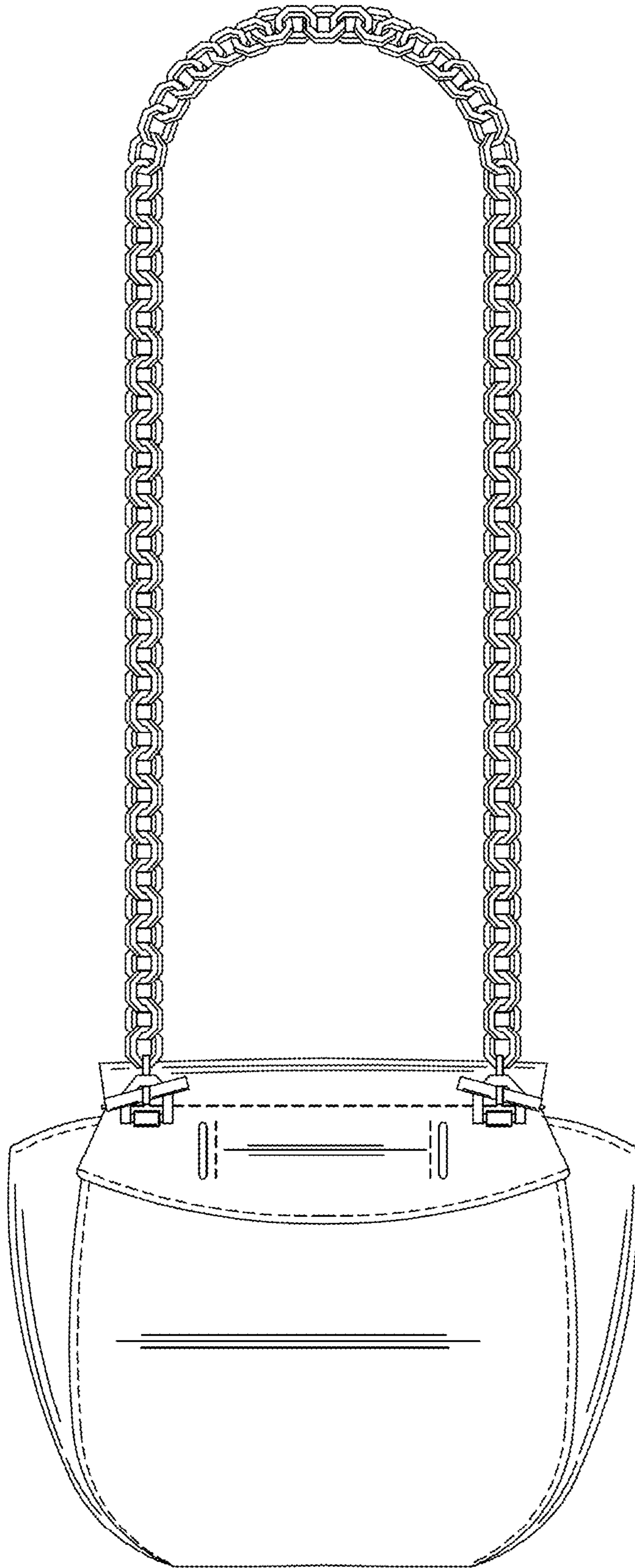

FIG. 4

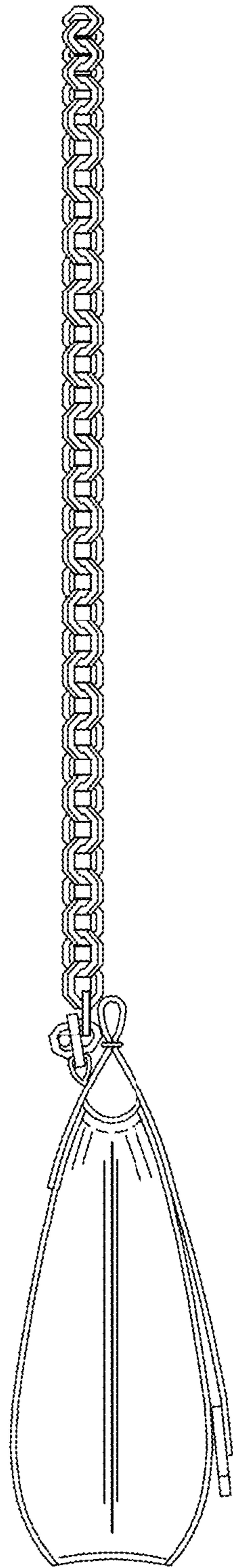

FIG. 5

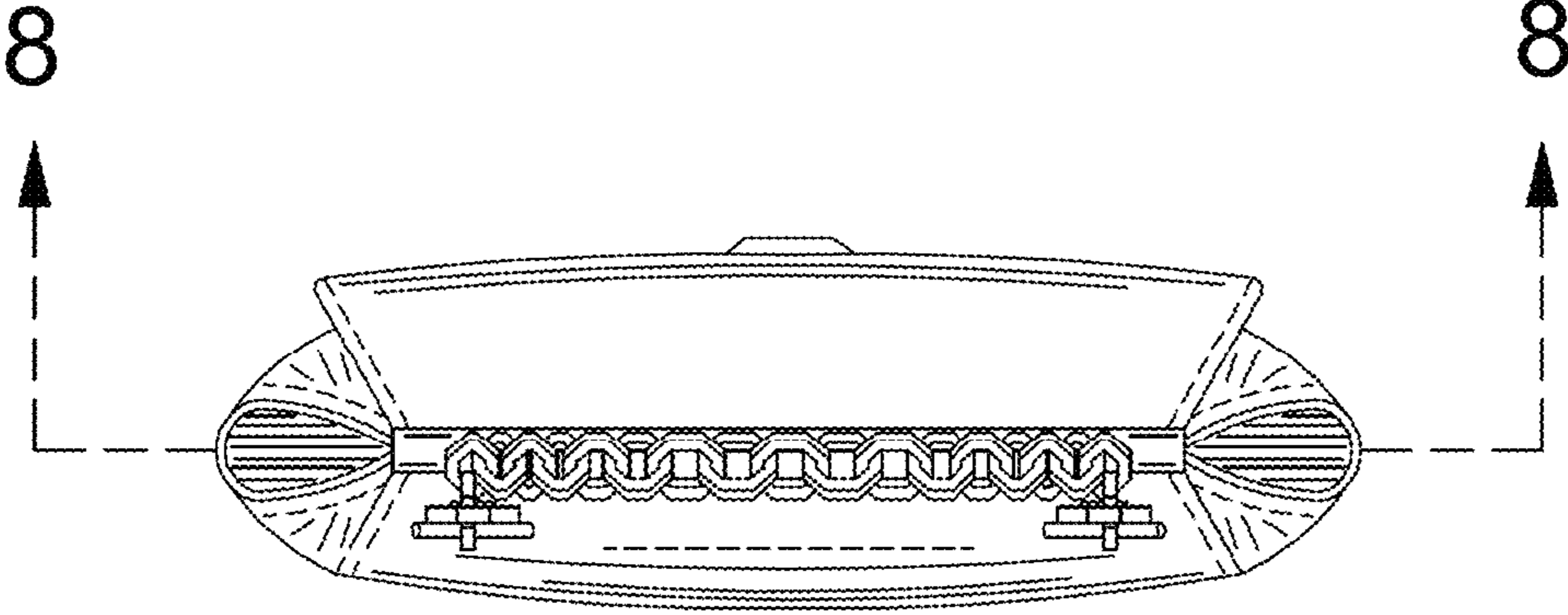

FIG. 6

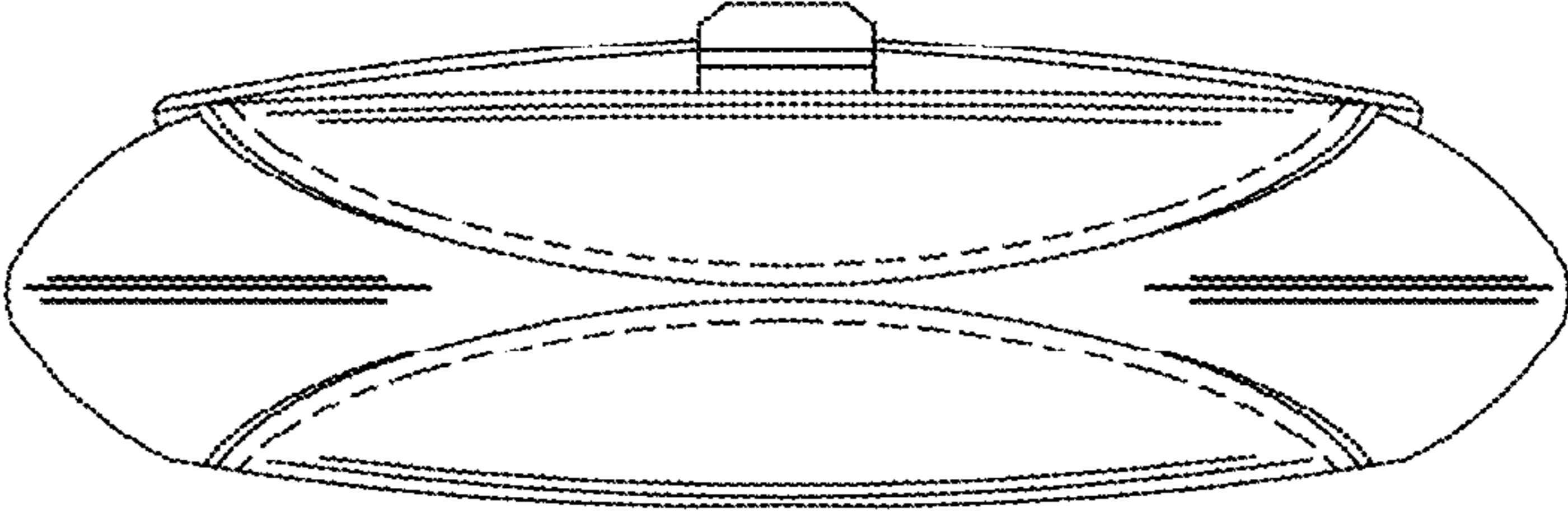

FIG. 7

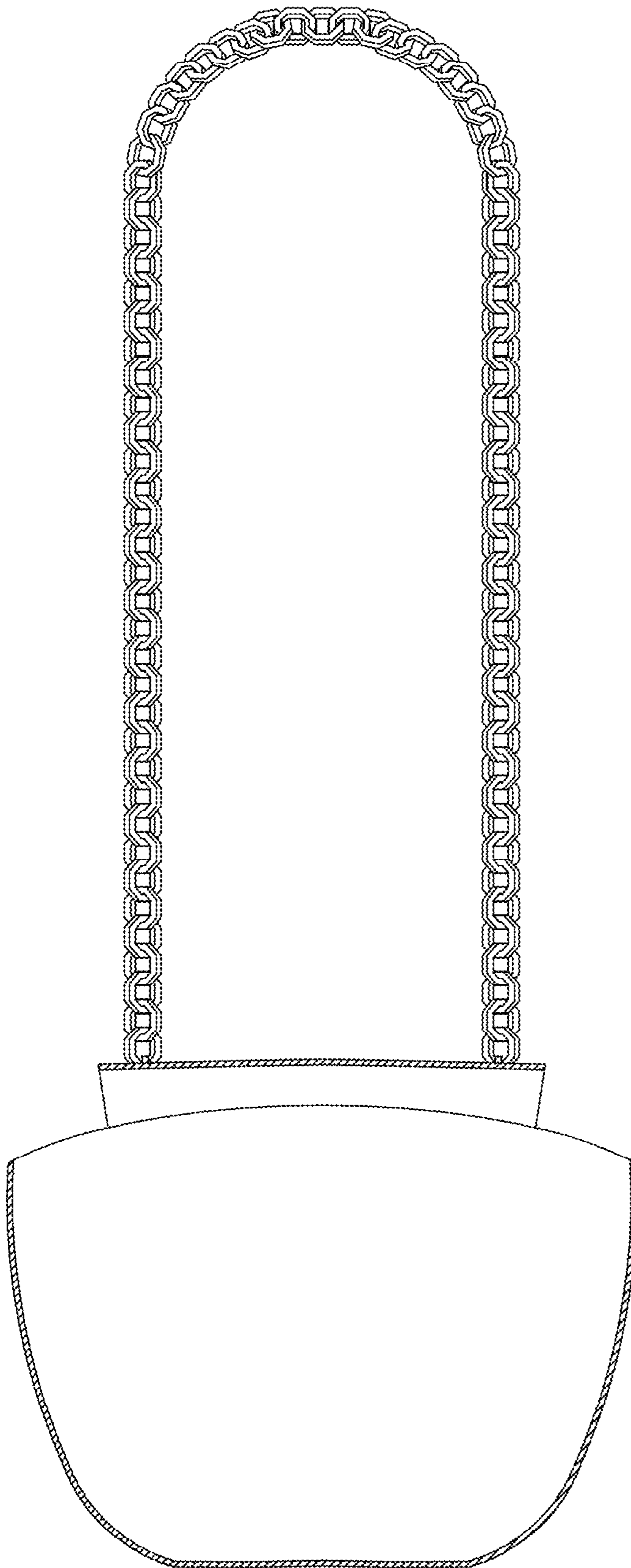

FIG. 8