



US00D878728S

(12) **United States Design Patent** (10) **Patent No.:** **US D878,728 S**
Van De Stouwe et al. (45) **Date of Patent:** **** Mar. 24, 2020**

(54) **FOOTWEAR**

(71) Applicant: **J. Choo Limited**, London (GB)

(72) Inventors: **John Maurice Van De Stouwe**,
London (GB); **Samuel D’Avoine**,
London (GB)

(73) Assignee: **J. Choo Limited**, London (GB)

(**) Term: **15 Years**

(21) Appl. No.: **29/687,117**

(22) Filed: **Apr. 10, 2019**

(30) **Foreign Application Priority Data**

Nov. 9, 2018 (EM) 005822004-0005

(51) **LOC (12) Cl.** **02-04**

(52) **U.S. Cl.**
USPC **D2/969**

(58) **Field of Classification Search**
USPC D2/896, 897, 902, 904, 906–908, 946,
D2/969, 972–974; D5/47, 49, 50, 53, 54,
D5/56, 60

CPC ... A43B 13/181; A43B 13/141; A43B 13/186;
A43B 13/188; A43B 23/00; A43B 23/02;
A43B 5/00; A43B 23/26; A43B 1/04;
A43B 11/14; A43B 7/00; A43B 3/12;
A43C 3/00; A43C 5/00; A43C 7/00;
A43C 11/004

See application file for complete search history.

(56) **References Cited**

U.S. PATENT DOCUMENTS

D236,662 S * 9/1975 Cotton D2/944
D284,616 S 7/1986 Gamm
D333,376 S 2/1993 Raffe
D373,461 S * 9/1996 Smith D2/969
D394,342 S 5/1998 Schneider
D397,240 S * 8/1998 Hatfield D2/972
D405,946 S 2/1999 Egelja et al.

D471,349 S * 3/2003 Nason D2/969
D479,643 S 9/2003 O’Shea et al.
D480,553 S * 10/2003 Adams D2/969
D484,675 S * 1/2004 Burg D2/972
D488,916 S 4/2004 McClaskie
D500,586 S * 1/2005 Wozniak D2/972
D502,309 S * 3/2005 Belley D2/969
D506,603 S * 6/2005 Hubbard D2/972
D511,614 S * 11/2005 Gerber D2/972
D516,286 S * 3/2006 Hubbard D2/972
D539,021 S * 3/2007 Belley D2/969
D541,026 S 4/2007 James
D552,334 S 10/2007 Lee
D561,450 S * 2/2008 Belley D2/969

(Continued)

OTHER PUBLICATIONS

Footwear—Oversized Runner by Alexander McQueen (https://www.alexandermcqueen.com/us/alexandermcqueen/runner_cod11637288rk.html#dept=m_sneakers_spl)—published at least earlier than Nov. 9, 2017.

Primary Examiner — Dominic V Simone
(74) *Attorney, Agent, or Firm* — Fross Zelnick Lehrman & Zissu, P.C.; Lawrence E. Apolzon, Esq.

(57) **CLAIM**

The ornamental design for a footwear, as shown and described.

DESCRIPTION

FIG. 1 is a front perspective view of a footwear showing our new design;
FIG. 2 is a front view thereof;
FIG. 3 is a back view thereof;
FIG. 4 is a left side view thereof;
FIG. 5 is a right side view thereof;
FIG. 6 is a top view thereof; and,
FIG. 7 is a bottom view thereof.
The broken lines showing of portions in the drawings shows unclaimed subject matter.

1 Claim, 7 Drawing Sheets

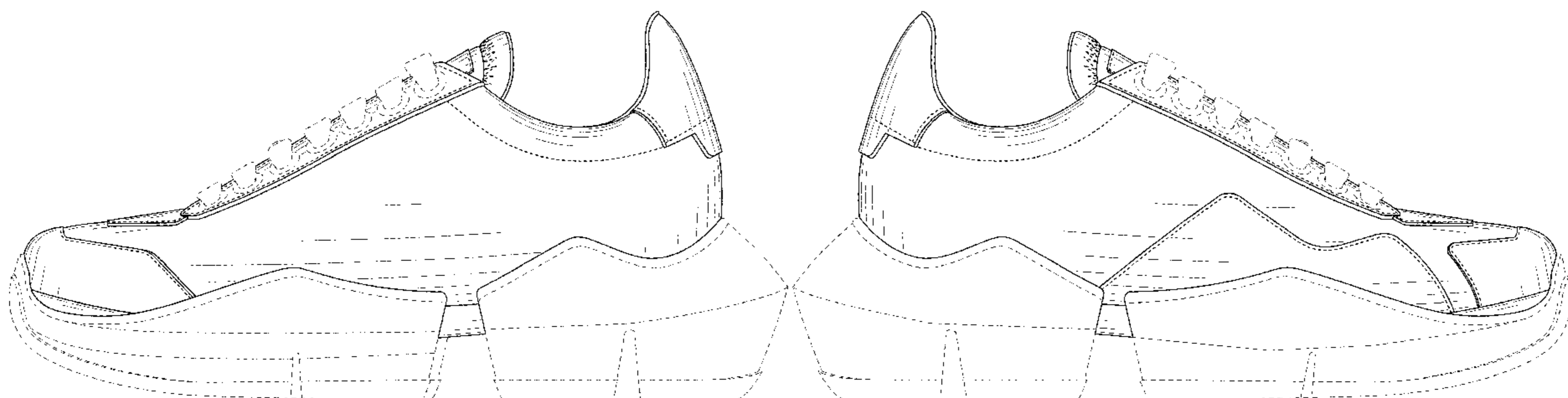

(56)

References Cited

U.S. PATENT DOCUMENTS

D562,539 S	2/2008	Hulbert	
D572,898 S *	7/2008	Stauffer	D2/972
D672,129 S *	12/2012	Bell	D2/969
D672,949 S	12/2012	Bramani	
D690,091 S	9/2013	Dombrow	
D699,420 S	2/2014	Teteriatnikov	
D712,133 S *	9/2014	Miner	D2/972
D713,631 S	9/2014	Millogo	
D718,035 S *	11/2014	Hardman	D2/972
D727,002 S	4/2015	Sassi	
D728,212 S *	5/2015	Mochen	D2/969
D750,362 S	3/2016	Bizzo	
D761,537 S	7/2016	Gavrieli et al.	
D765,370 S	9/2016	Silverman	
D767,861 S	10/2016	Wattimena	
D780,425 S *	3/2017	Abe	D2/972
D787,169 S	5/2017	Sassi	
D789,058 S	6/2017	Pierone	
D796,816 S *	9/2017	Klein	D2/972
D798,580 S *	10/2017	McMillan	D2/972
D799,189 S *	10/2017	Odinot	D2/972
D801,035 S *	10/2017	Odinot	D2/972
D804,157 S	12/2017	Pierone	
D805,742 S *	12/2017	Ochipa	D2/969
D807,632 S *	1/2018	Sullivan	D2/972
D812,362 S *	3/2018	Gibson	D2/972
D814,167 S *	4/2018	Cooke	D2/972
D821,731 S *	7/2018	McCaffrey	D2/972
D821,733 S *	7/2018	Avar	D2/973
D827,276 S *	9/2018	Ringholz	D2/969
D828,002 S *	9/2018	Buscemi	D2/972
D834,295 S *	11/2018	Cabada	D2/969
D835,391 S *	12/2018	Durflinger	D2/972
D838,942 S	1/2019	Sassi	
D853,702 S	7/2019	Mokos et al.	
D856,653 S	8/2019	Thompson	
D862,051 S	10/2019	Goussey	
D862,866 S	10/2019	Albrecht et al.	

* cited by examiner

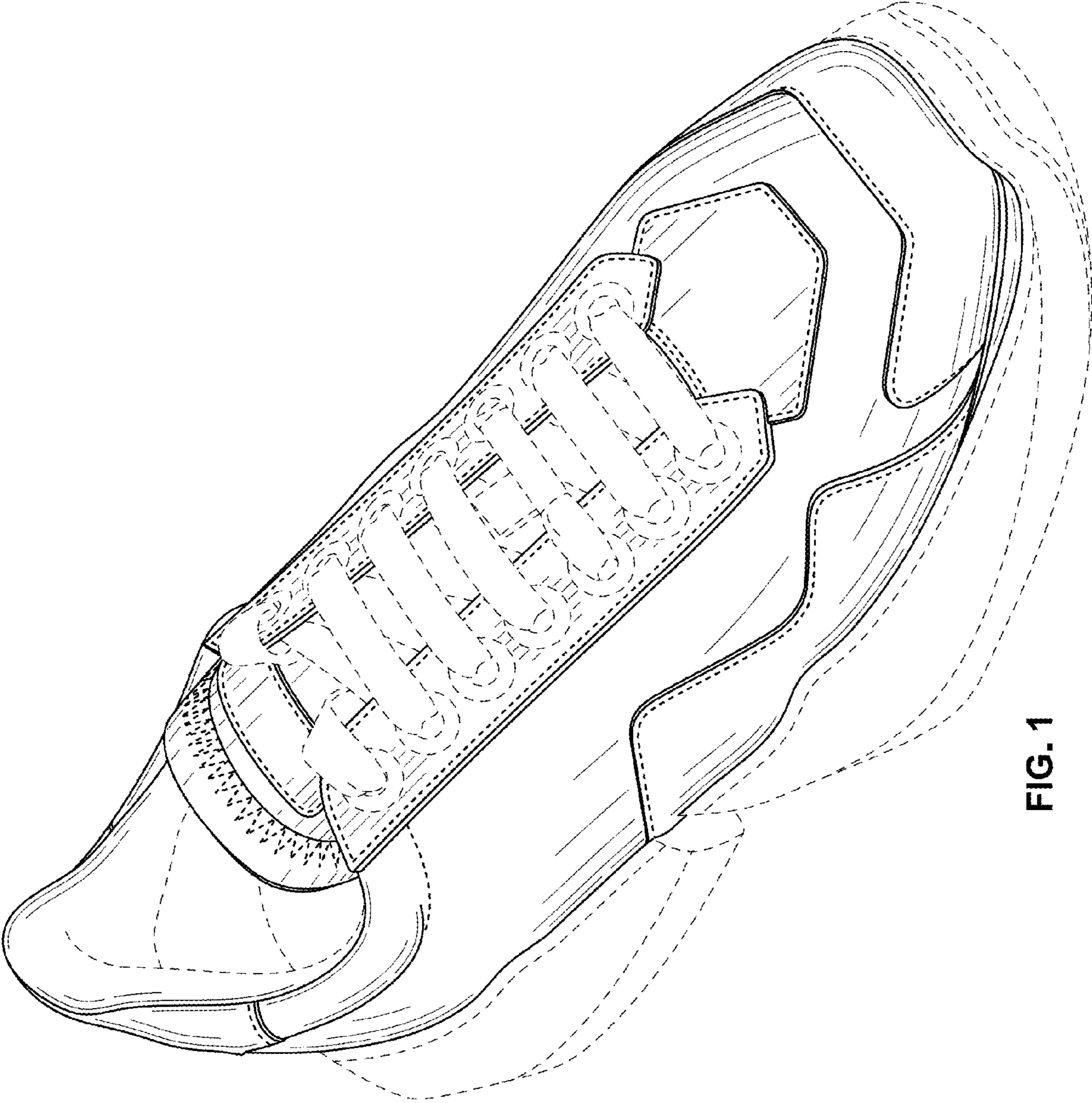

FIG. 1

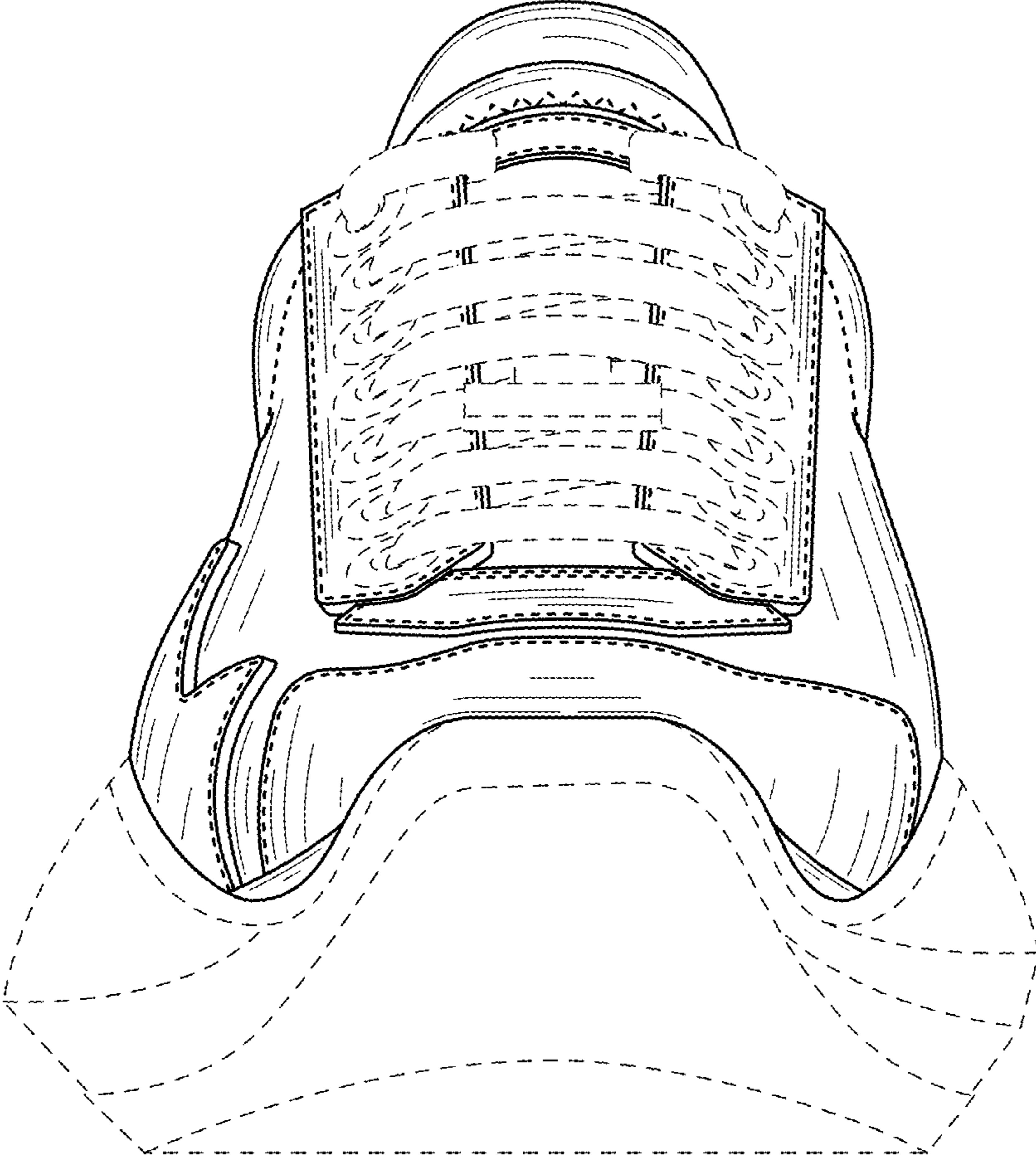

FIG. 2

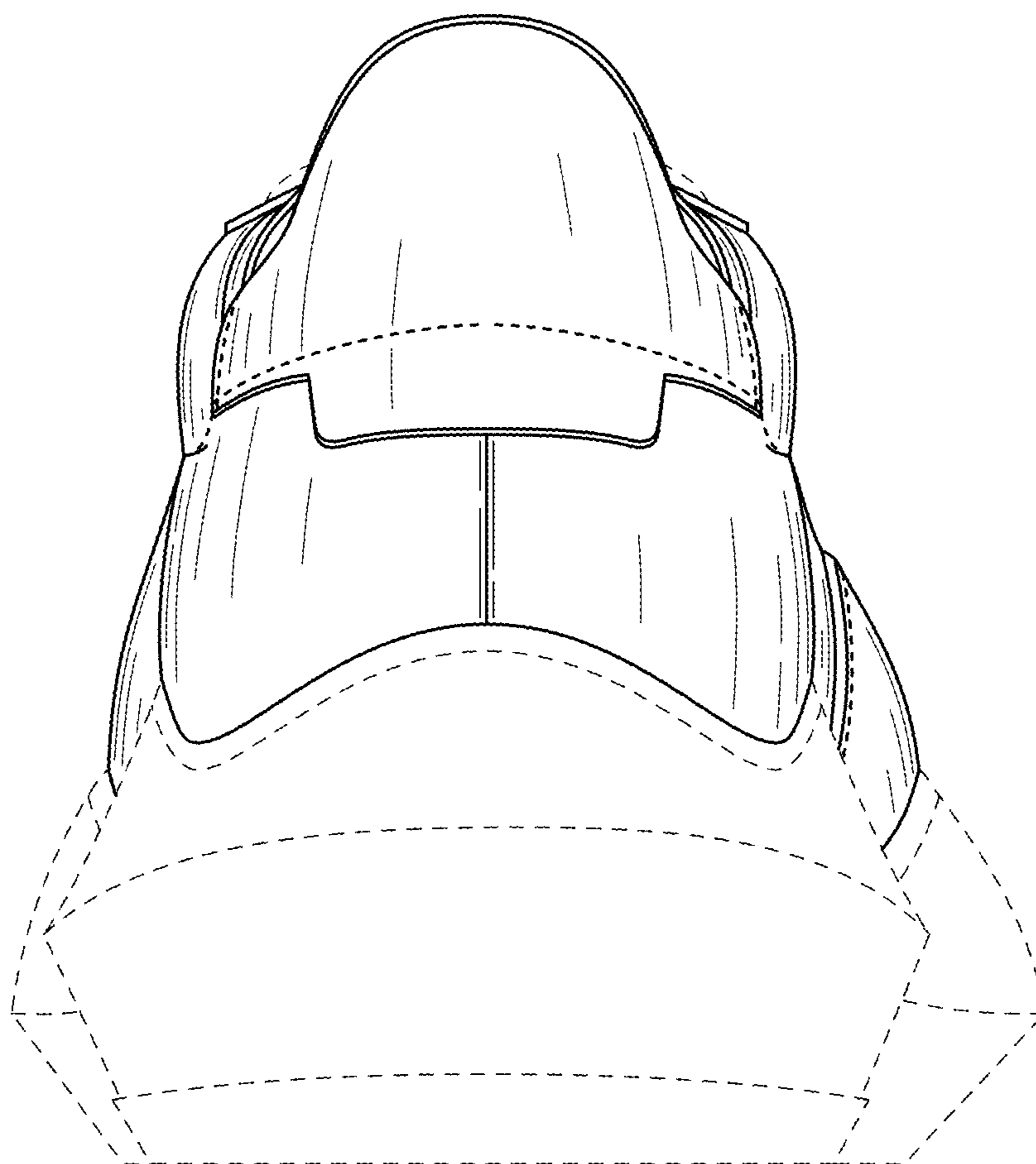

FIG. 3

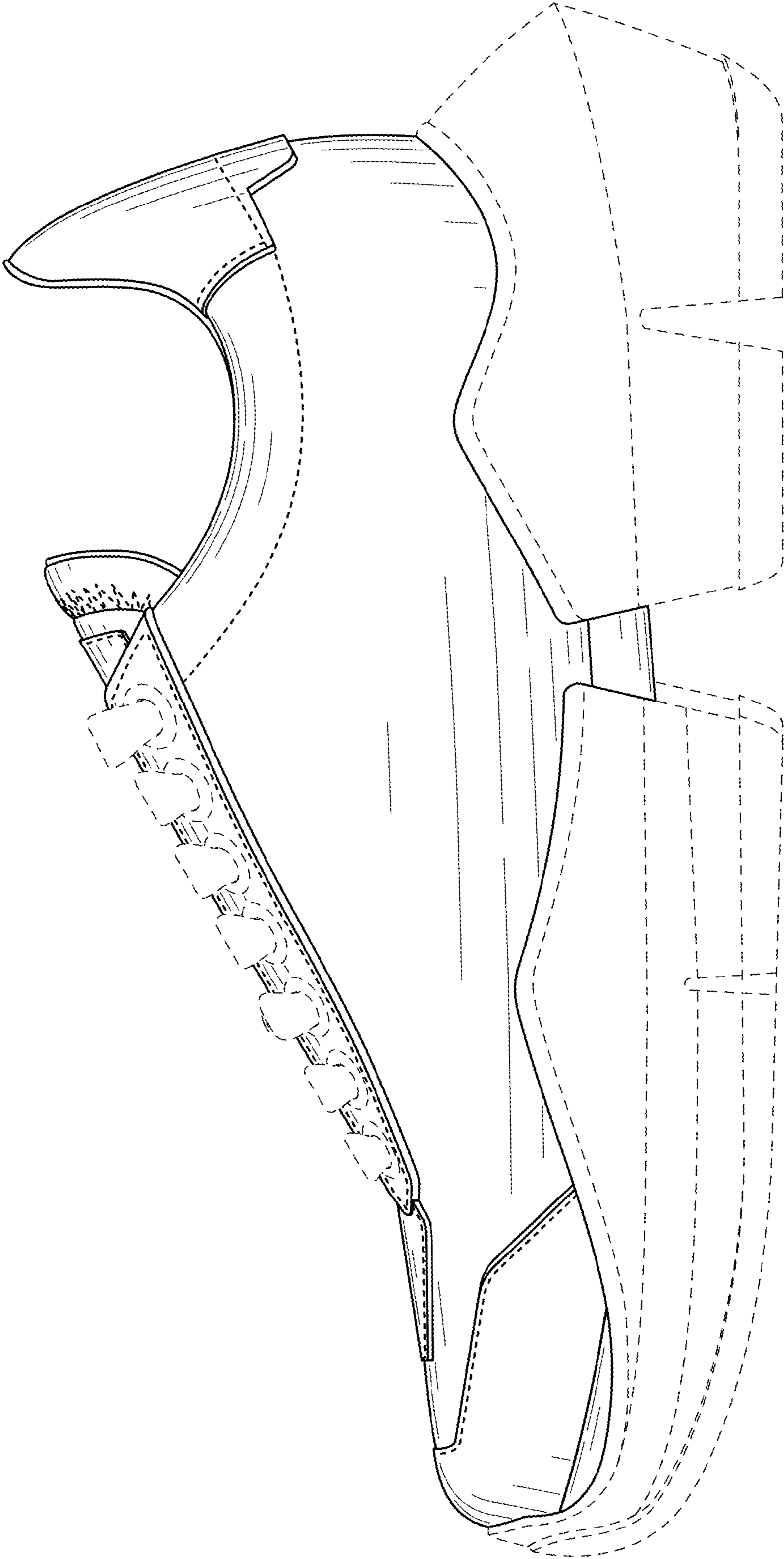

FIG. 4

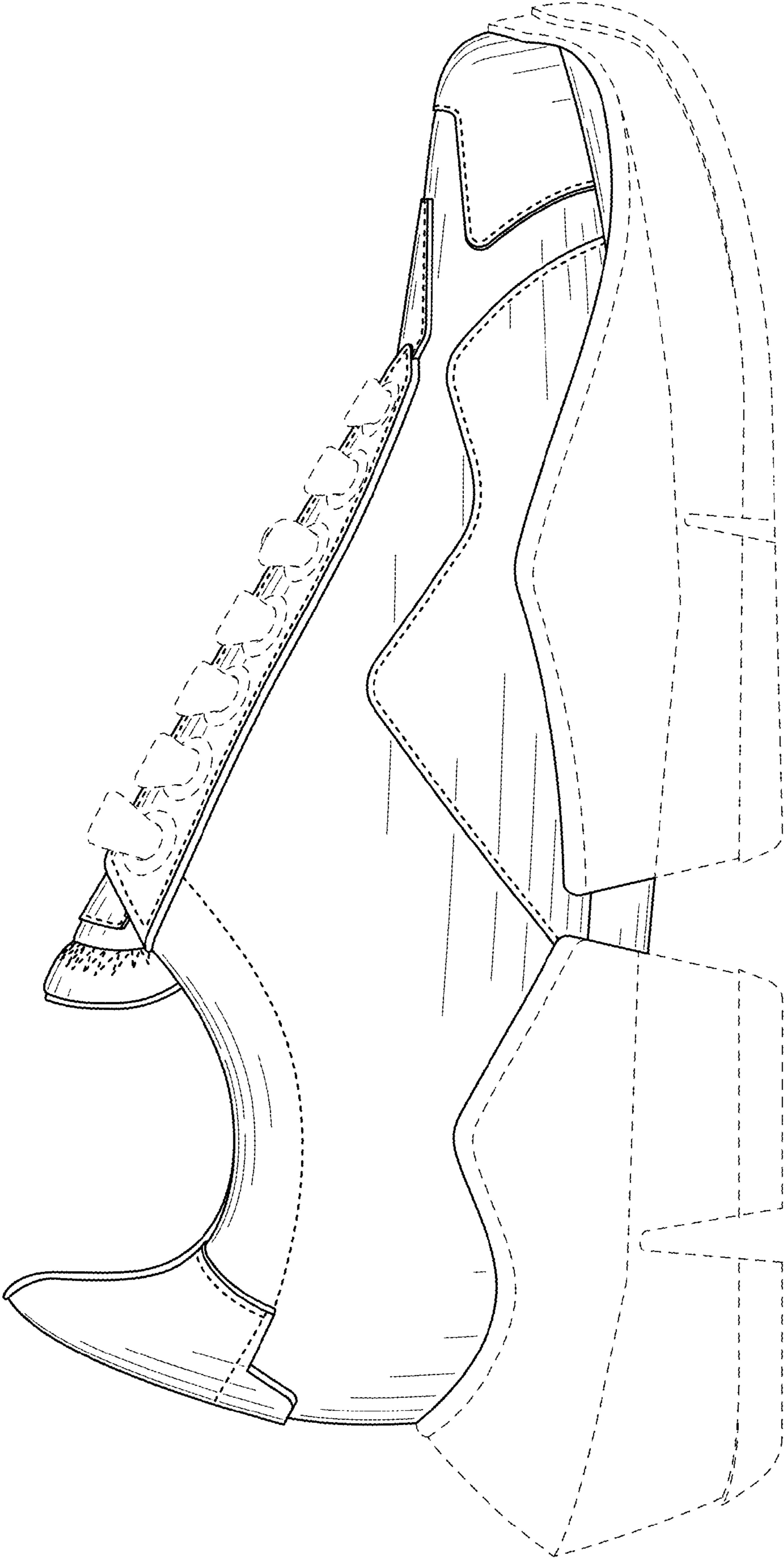

FIG. 5

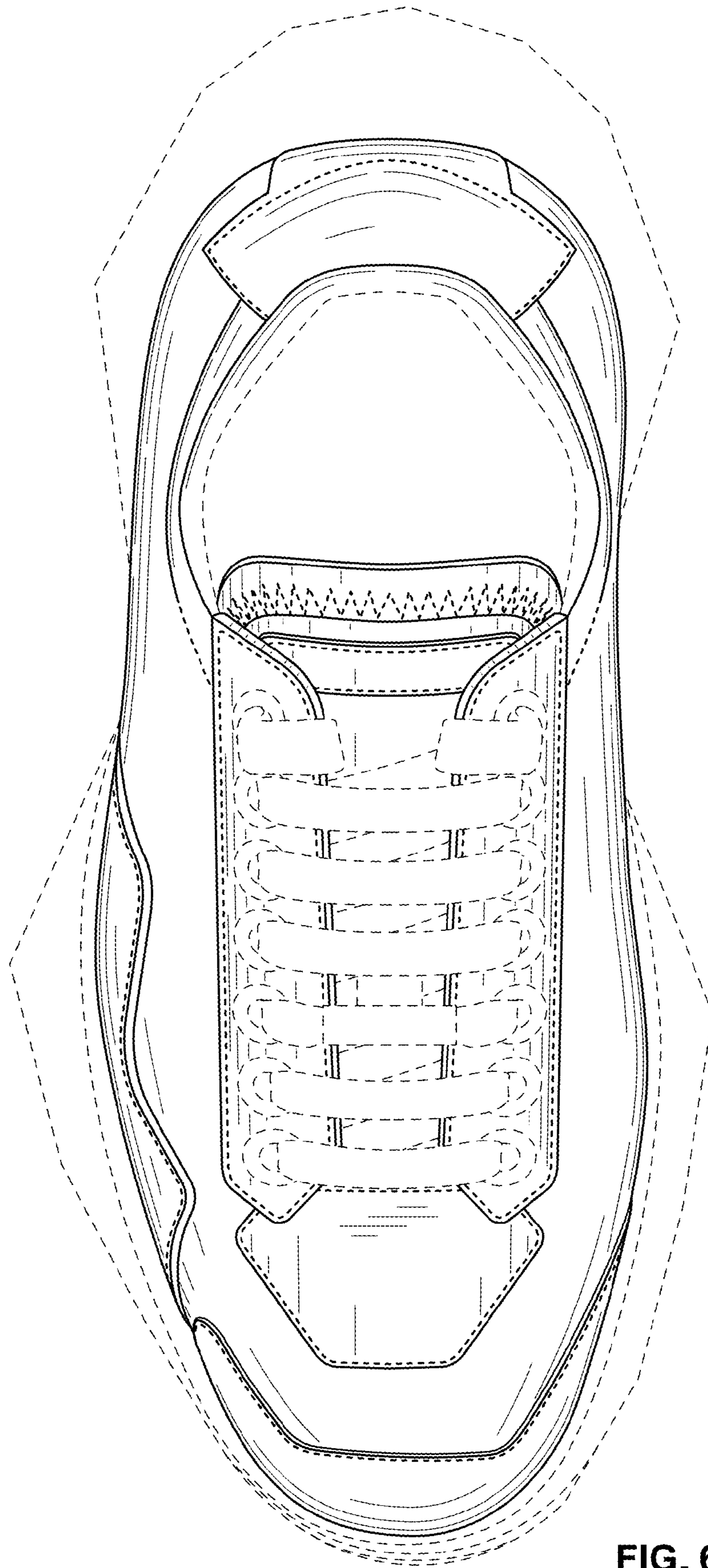

FIG. 6

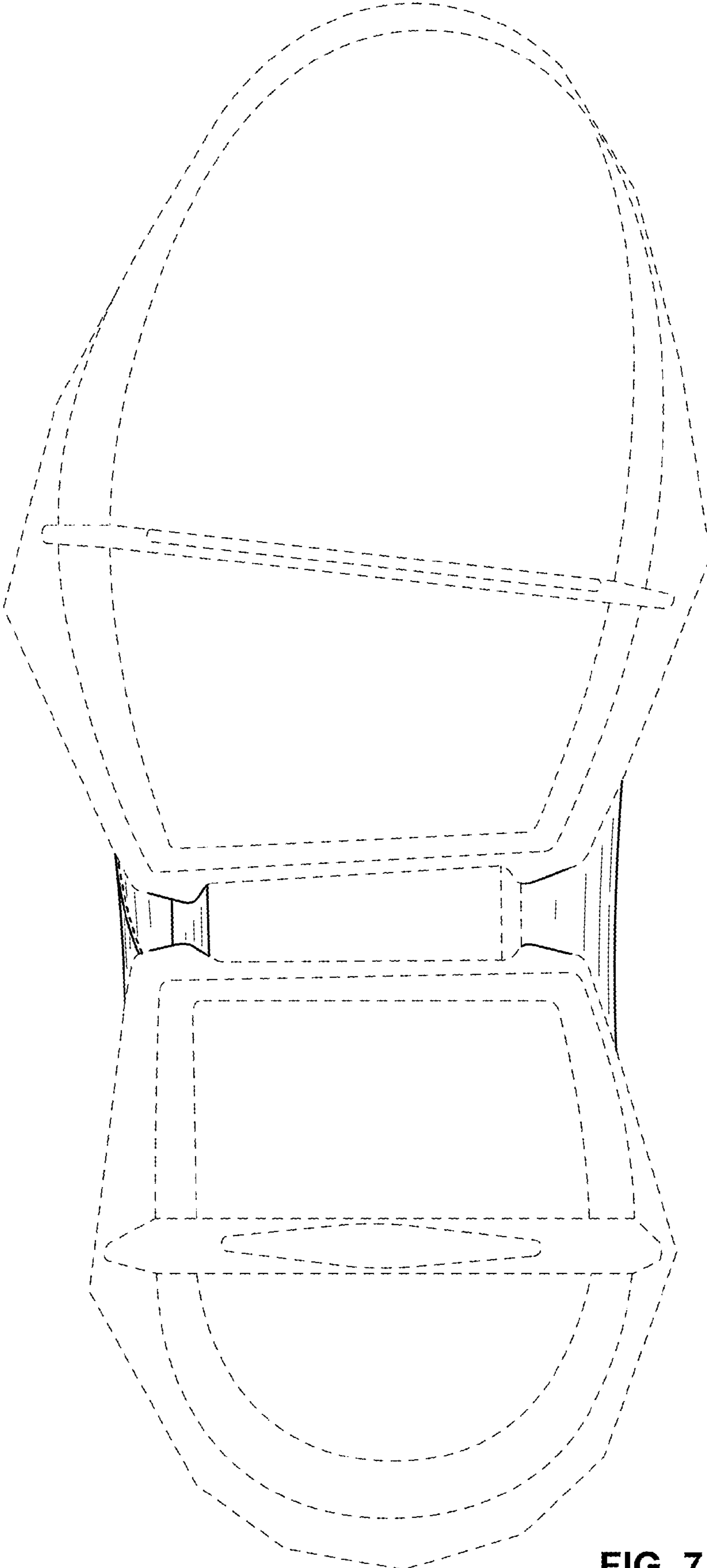

FIG. 7