



US00D878727S

(12) **United States Design Patent**  
**Ikeda et al.**

(10) **Patent No.:** **US D878,727 S**  
(45) **Date of Patent:** **\*\* Mar. 24, 2020**

- (54) **SHOE**
- (71) Applicant: **NIKE, Inc.**, Beaverton, OR (US)
- (72) Inventors: **Erick Ikeda**, Beaverton, OR (US);  
**Kreig Hozalski**, Beaverton, OR (US)
- (73) Assignee: **NIKE, Inc.**, Beaverton, OR (US)
- (\*\*) Term: **15 Years**
- (21) Appl. No.: **29/676,574**
- (22) Filed: **Jan. 11, 2019**
- (51) **LOC (12) Cl.** ..... **02-04**
- (52) **U.S. Cl.**  
USPC ..... **D2/969**; D2/974
- (58) **Field of Classification Search**  
USPC ..... D2/896–900, 909–911, 943, 946, 969,  
D2/970–974  
CPC ..... A43C 1/00; A43C 11/004; A43B 3/16;  
A43B 23/00  
See application file for complete search history.

- (56) **References Cited**  
U.S. PATENT DOCUMENTS  
D136,965 S \* 1/1944 Ascheim ..... D2/911  
4,441,265 A \* 4/1984 Burns ..... A43B 5/00  
36/114  
5,771,608 A \* 6/1998 Peterson ..... A43B 5/00  
36/50.1

- D527,886 S \* 9/2006 Morris ..... D2/972
- D603,587 S \* 11/2009 Boone ..... D2/896
- D674,178 S \* 1/2013 Petrie ..... D2/972
- D757,415 S \* 5/2016 Spring ..... D2/970
- D762,371 S \* 8/2016 McClaskie ..... D2/970
- D762,956 S \* 8/2016 McClaskie ..... D2/943
- D763,554 S \* 8/2016 Slimane ..... D2/911
- D787,797 S \* 5/2017 Spring ..... D2/970
- D858,080 S \* 9/2019 Petrie ..... D2/973

\* cited by examiner

*Primary Examiner* — Rashida C. Walshon  
(74) *Attorney, Agent, or Firm* — Banner & Witcoff, Ltd.

(57) **CLAIM**

The ornamental design for a shoe, as shown and described.

**DESCRIPTION**

FIG. 1 is a front perspective view of a shoe showing our new design;  
 FIG. 2 is a side view thereof;  
 FIG. 3 is a rear perspective view thereof;  
 FIG. 4 is a rear view thereof;  
 FIG. 5 is an opposite rear perspective view thereof;  
 FIG. 6 is an opposite side view thereof; and,  
 FIG. 7 is an opposite front perspective view thereof.  
 The broken lines immediately adjacent to the shaded area define the bounds of the claimed design and form no part thereof. The broken lines depicting the remainder of the shoe show features that form no part of the claimed design.

**1 Claim, 7 Drawing Sheets**

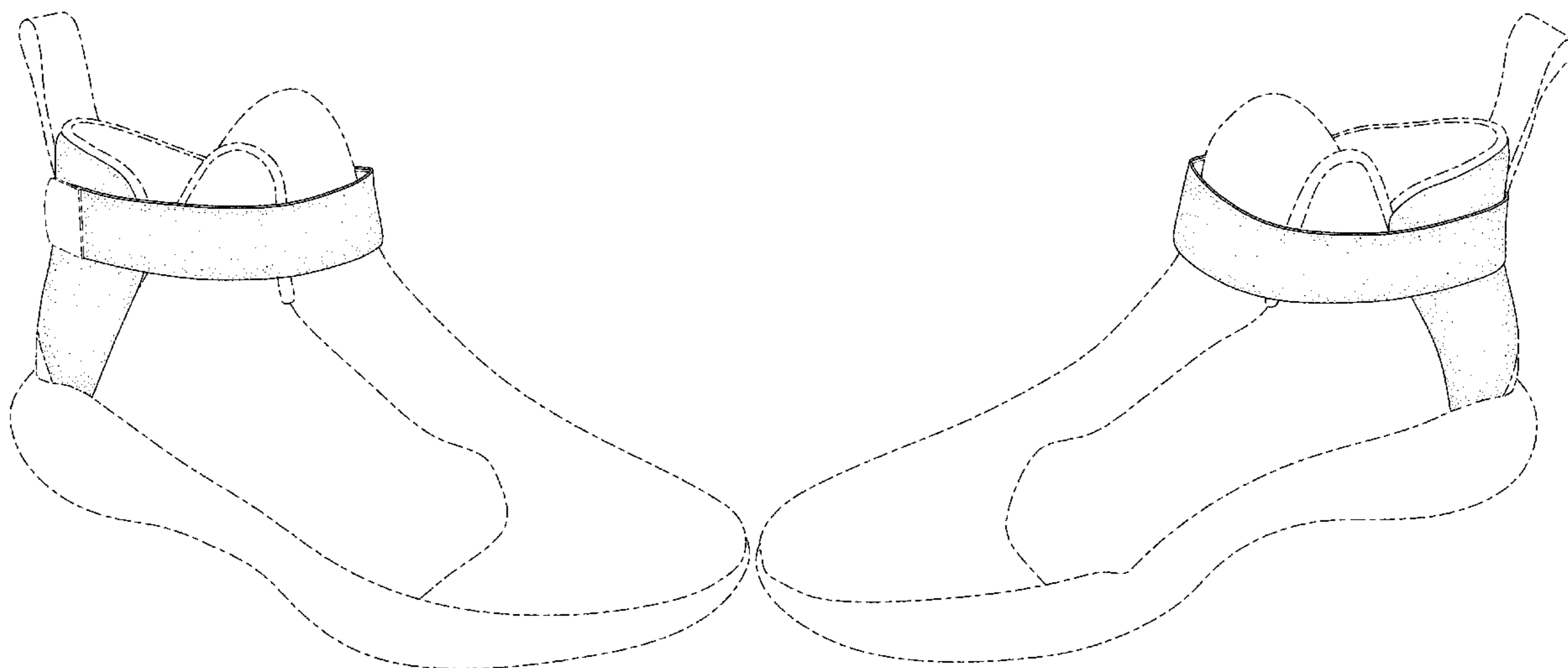

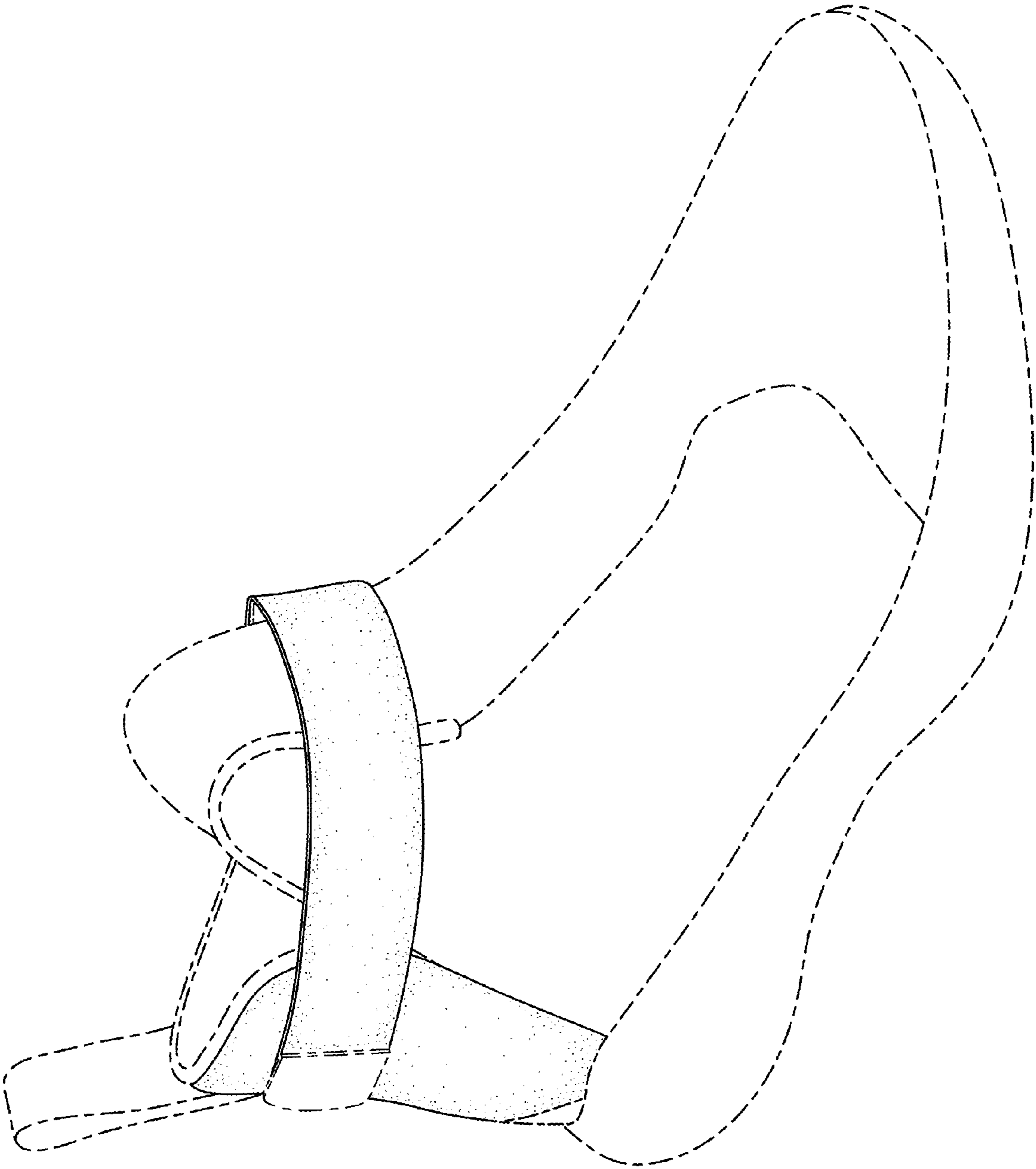

FIG. 1

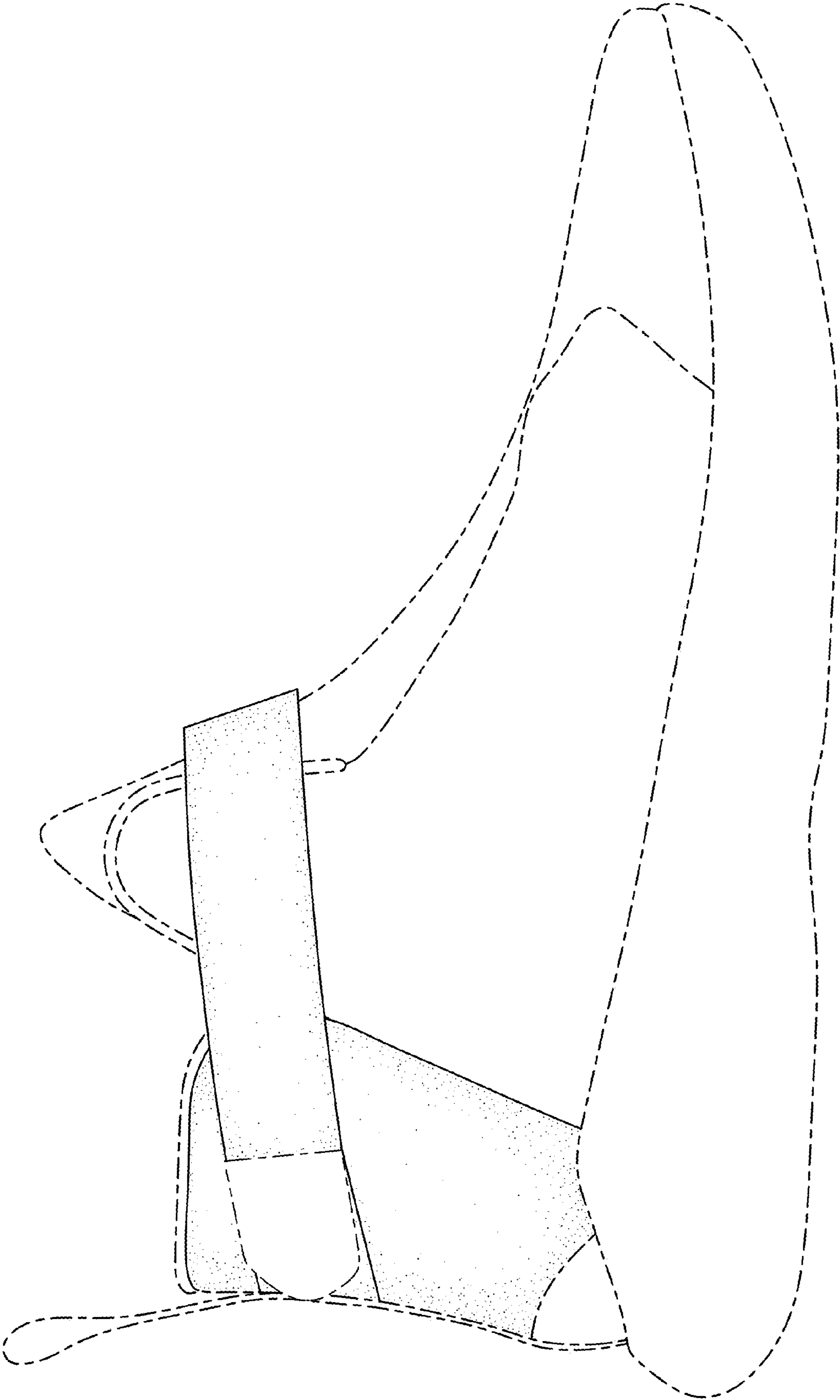

FIG. 2

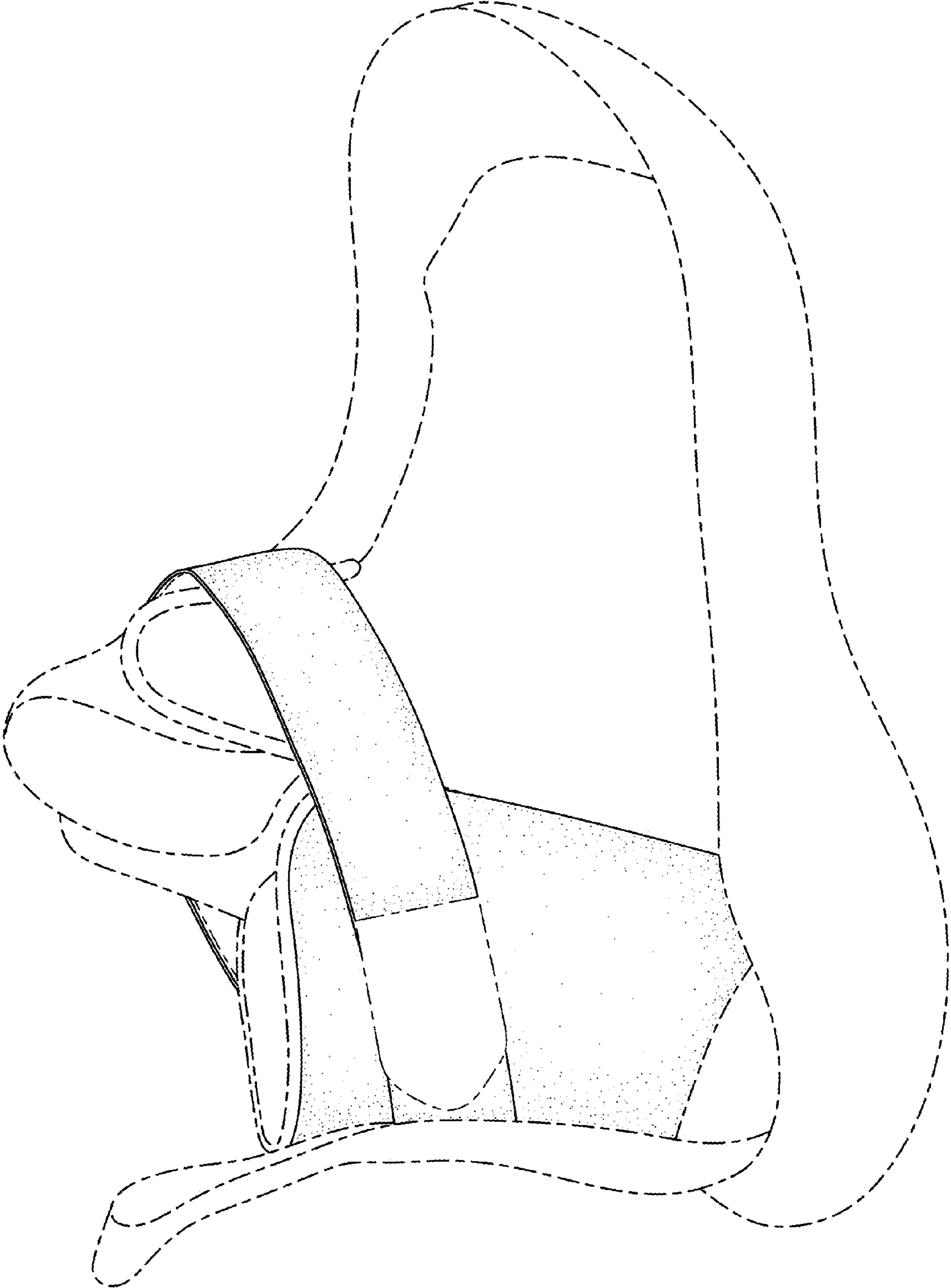

FIG. 3

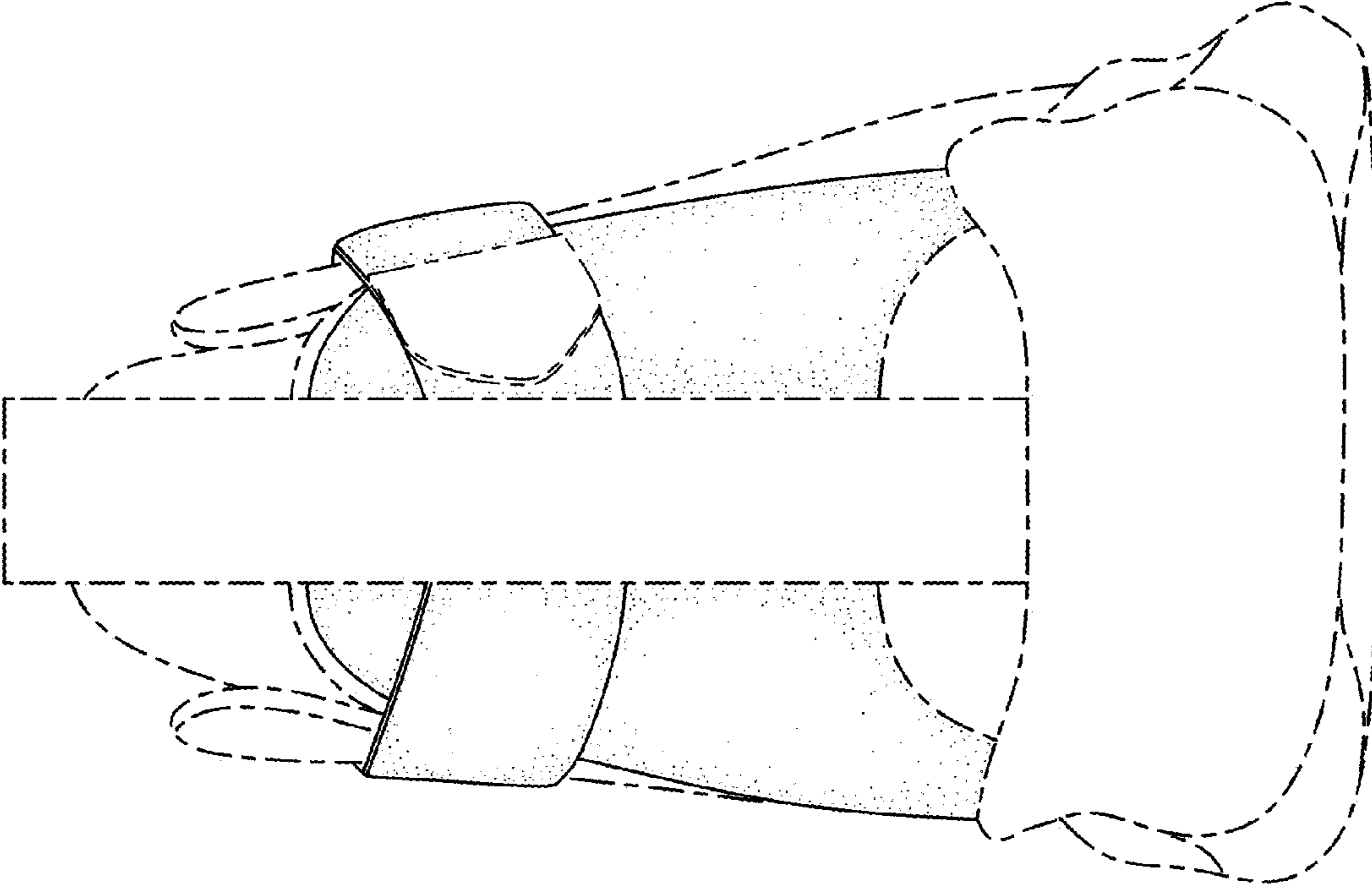

FIG. 4

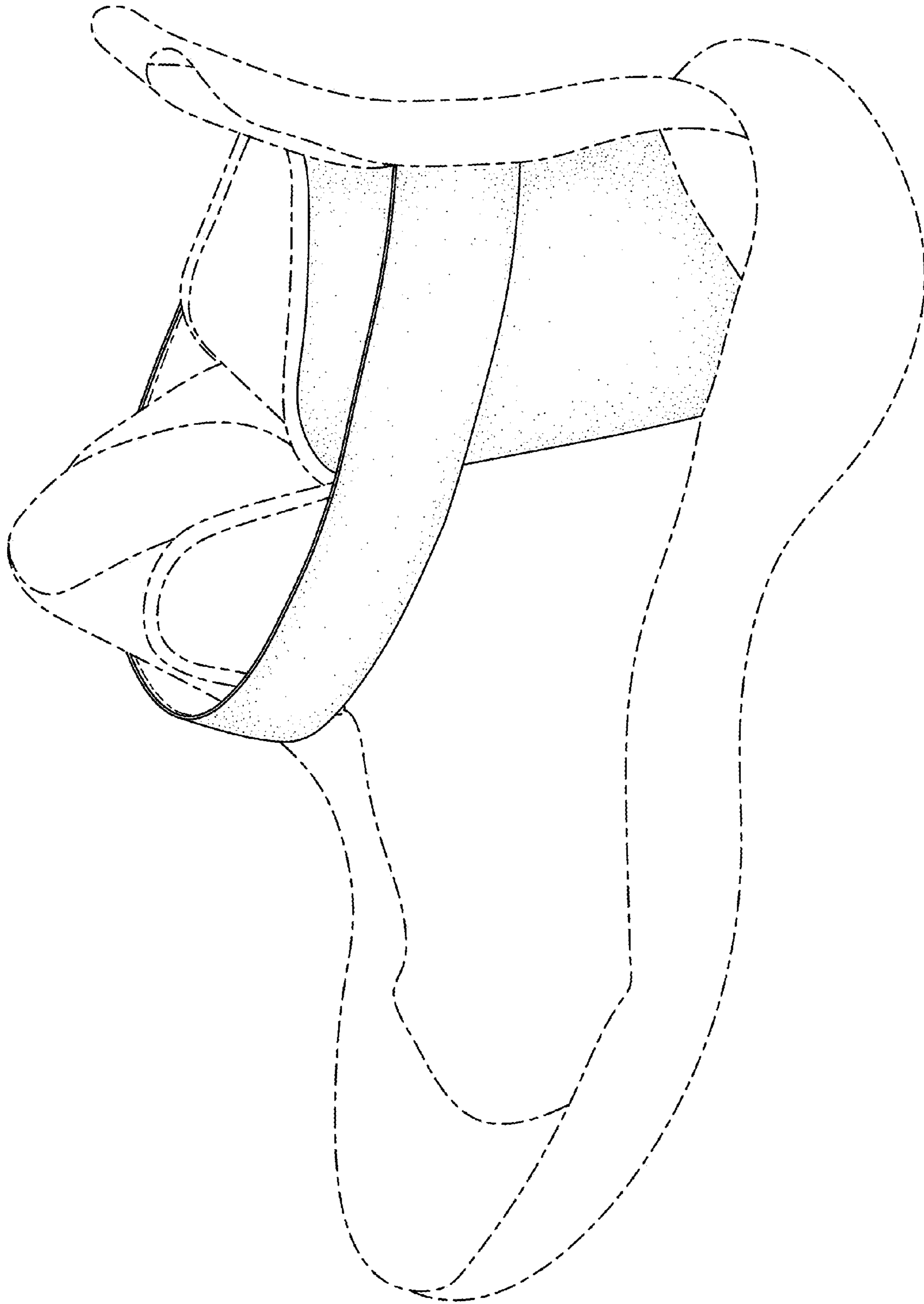

FIG. 5

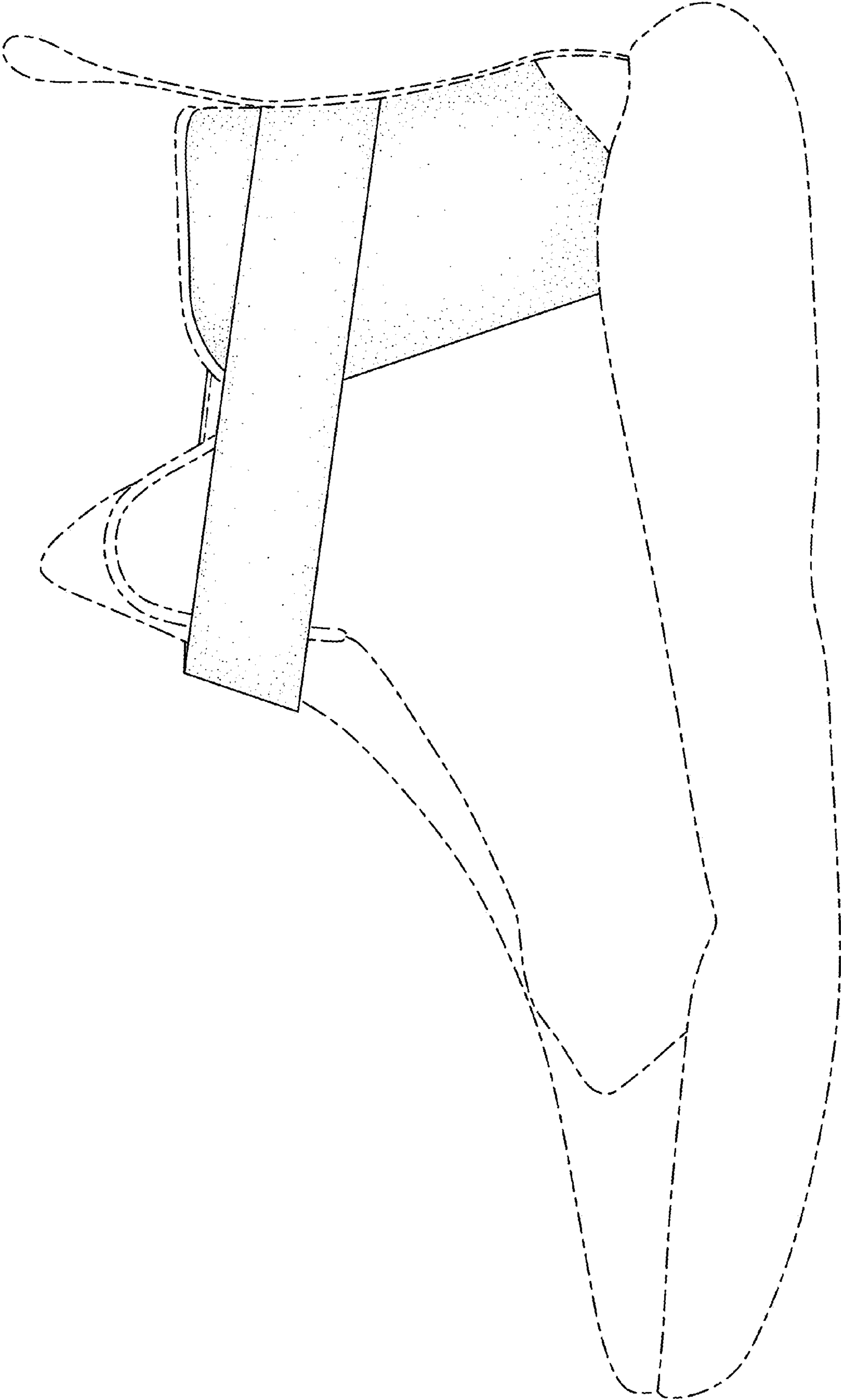

FIG. 6

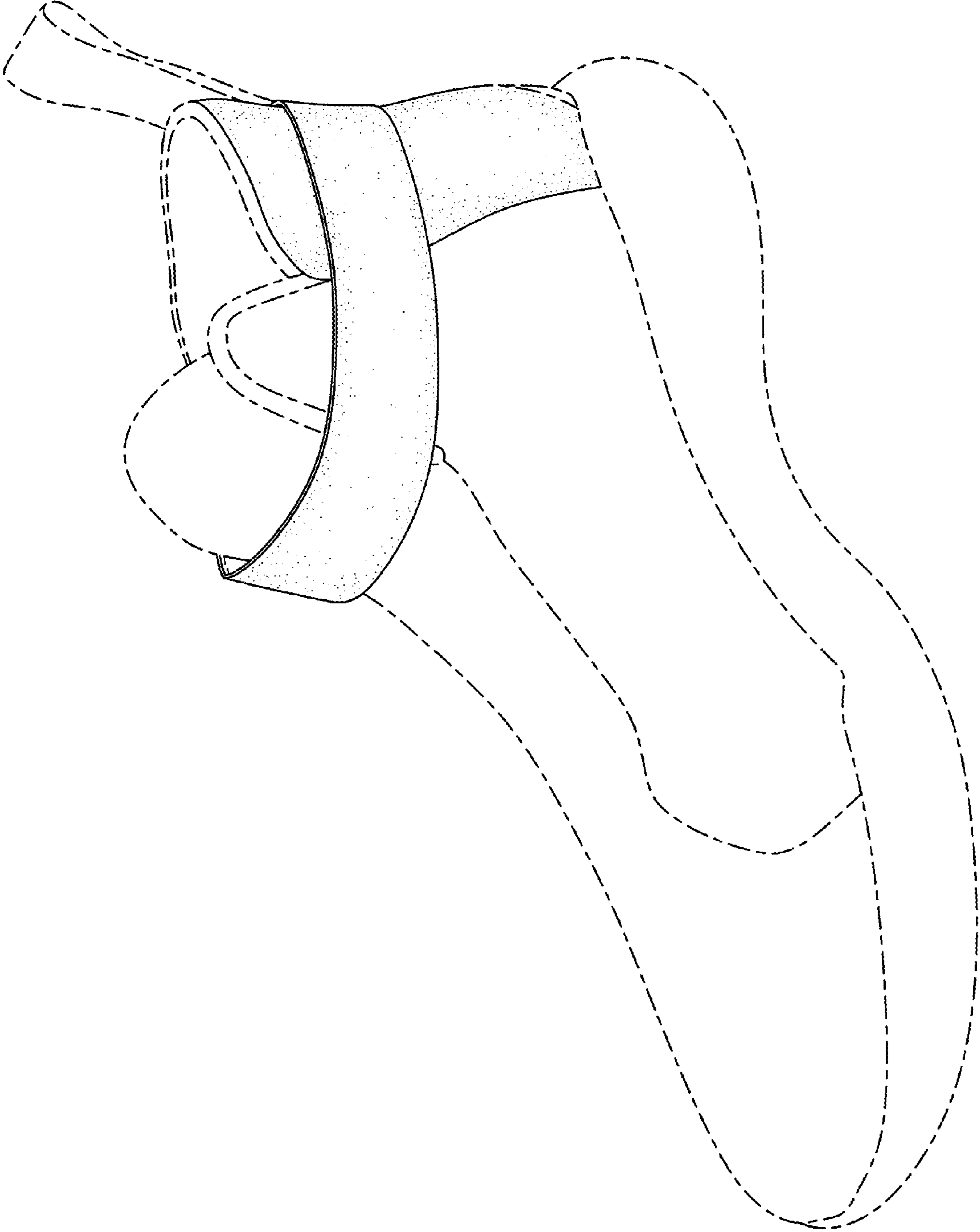

FIG. 7