



US00D878708S

(12) **United States Design Patent**
James

(10) **Patent No.:** **US D878,708 S**
(45) **Date of Patent:** **** Mar. 24, 2020**

- (54) **GARTER**
- (71) Applicant: **Amanda Lorene James**, Mathiston, MS (US)
- (72) Inventor: **Amanda Lorene James**, Mathiston, MS (US)
- (**) Term: **15 Years**
- (21) Appl. No.: **29/644,739**
- (22) Filed: **Apr. 20, 2018**
- (51) **LOC (12) Cl.** **02-07**
- (52) **U.S. Cl.**
USPC **D2/625**
- (58) **Field of Classification Search**
USPC D2/624-629, 631, 636-640, 701;
D3/224, 226; D11/200; D24/190;
D30/152
CPC .. A41F 9/025; A41F 9/02; A41F 9/007; A41F 9/002; A41F 9/00; A41F 5/00; A41F 3/04; A41F 3/02; A41F 3/00; A41F 15/00; A41F 11/16; A41F 11/14; A41F 11/08; A41F 11/02; A41F 11/00; A41F 1/08; A41F 1/002; A45F 2003/144
See application file for complete search history.

- (56) **References Cited**
U.S. PATENT DOCUMENTS
1,469,281 A * 10/1923 Stevens A41F 11/02
24/563
1,608,096 A * 11/1926 Friedman A41F 11/16
2/311
1,636,107 A * 7/1927 Namiot A41F 11/16
2/300
RE21,619 E * 11/1940 Schottenfels A41F 11/02
24/198
2,615,172 A * 10/1952 Donegan A41F 15/00
2/323

- 2,676,329 A * 4/1954 Dove A41F 3/00
2/310
- 2,694,205 A * 11/1954 Fish A41F 11/16
450/106
- 2,750,597 A * 6/1956 Blatt A41F 11/02
2/305
- 2,895,480 A * 7/1959 Fixel A41F 11/00
450/29
- 3,529,329 A * 9/1970 Burleson A41F 11/02
24/200
- D383,888 S * 9/1997 Smith A41F 15/00
D2/624
- 6,179,687 B1 * 1/2001 Lee A41F 1/006
2/67

(Continued)

Primary Examiner — Kevin K Rudzinski
Assistant Examiner — Clare Ann Gannon
(74) *Attorney, Agent, or Firm* — AdamsIP, LLC; J. Hunter Adams

(57) **CLAIM**
The ornamental design for a garter, as shown and described.

DESCRIPTION

FIG. 1 is a front view of a garter showing the claimed design;
FIG. 2 is a rear view thereof;
FIG. 3 is a left side view thereof;
FIG. 4 is a right side view thereof;
FIG. 5 is a top view thereof;
FIG. 6 is a bottom view thereof;
FIG. 7 is a front perspective view thereof;
FIG. 8 is an enlarged detail view of the area 8 in FIG. 7; and,
FIG. 9 is an enlarged detail view of the area 9 in FIG. 7.
The dashed broken lines in the figures show portions of the garter that form no part of the claimed design. The dot-dash broken lines in the figures show boundaries that form no part of the claimed design. The shade lines in the figures show contour and not surface ornamentation.

1 Claim, 4 Drawing Sheets

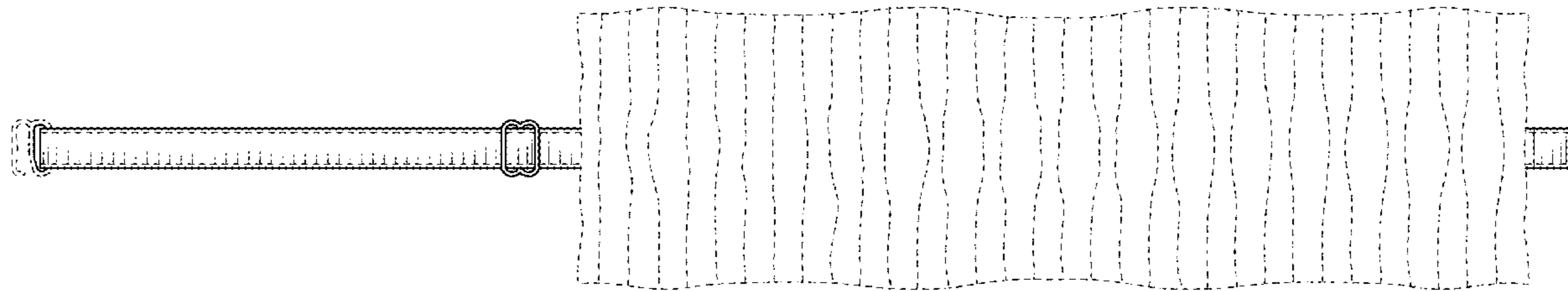

(56)

References Cited

U.S. PATENT DOCUMENTS

D445,723 S * 7/2001 Kim D11/218
D612,765 S * 3/2010 Fildan D11/200
D649,304 S * 11/2011 Cupples D30/145
D810,403 S * 2/2018 Grenville D2/853
D842,584 S * 3/2019 Soohoo D2/708
D844,907 S * 4/2019 Farrar A41F 1/006
D30/153
2008/0289084 A1* 11/2008 Wilkins A41F 9/002
2/312
2010/0093258 A1* 4/2010 Glenn A41F 15/00
450/86
2011/0230120 A1* 9/2011 Tully A41C 3/12
450/88
2011/0269376 A1* 11/2011 Clim A41F 15/00
450/86
2013/0074247 A1* 3/2013 Gernes A41F 9/00
2/321
2016/0106167 A1* 4/2016 Loshinsky A41F 3/00
2/323
2018/0184726 A1* 7/2018 Wesley A41C 3/12

* cited by examiner

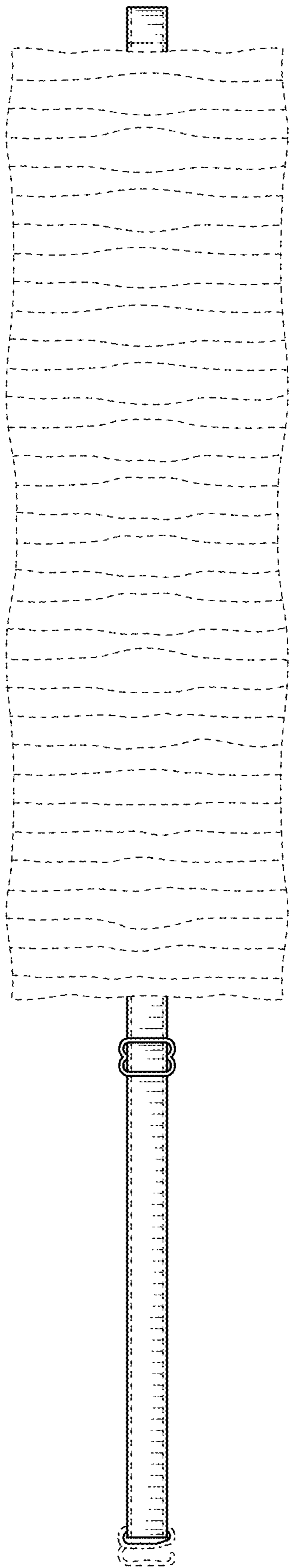

FIG. 1

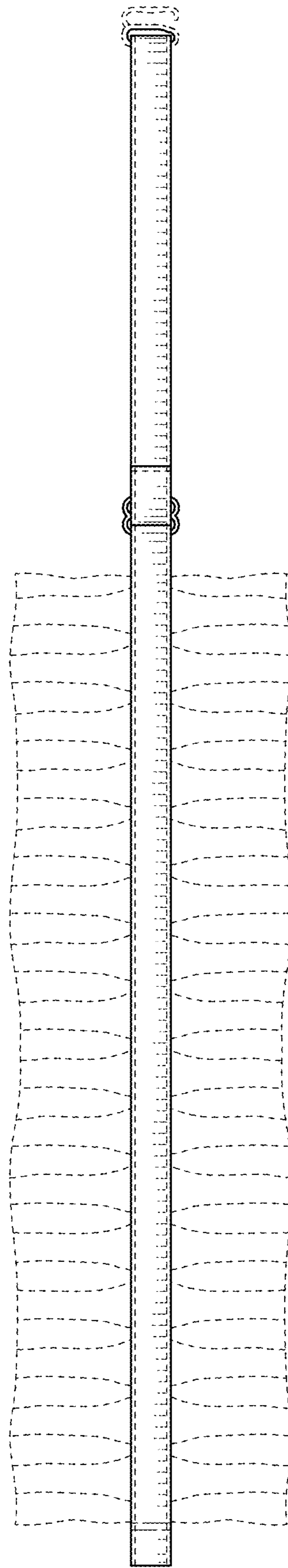

FIG. 2

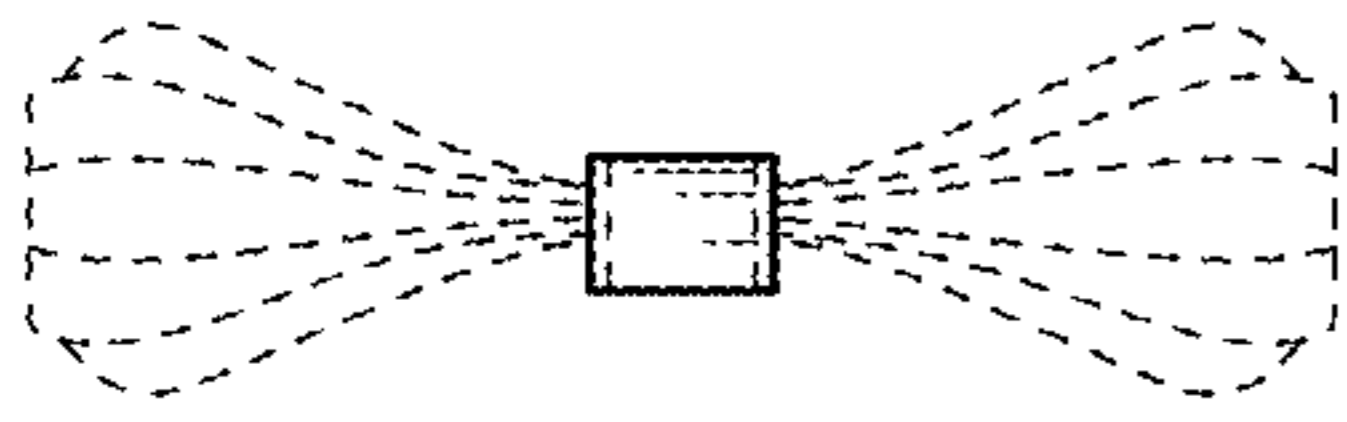

FIG. 4

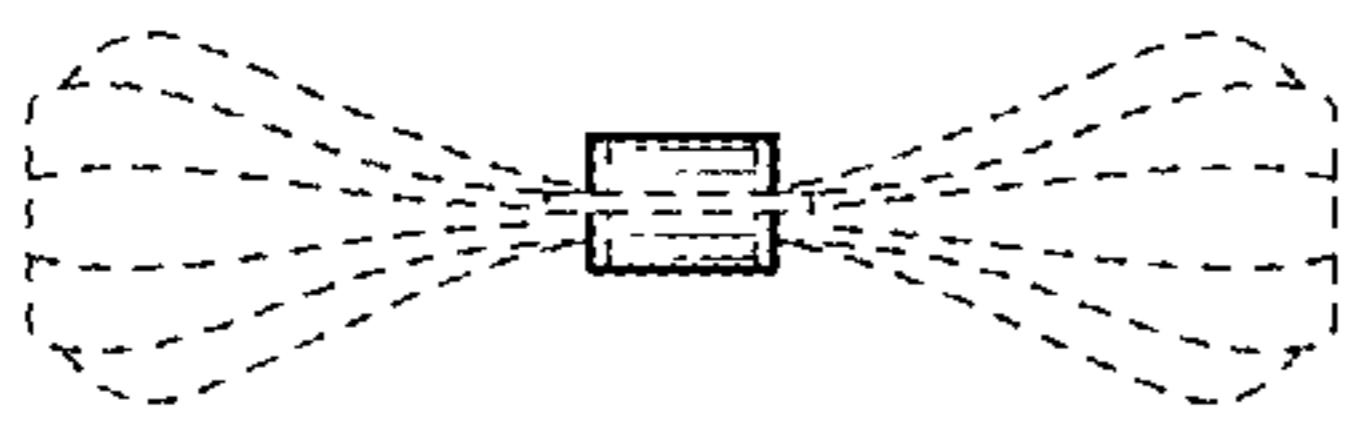

FIG. 3

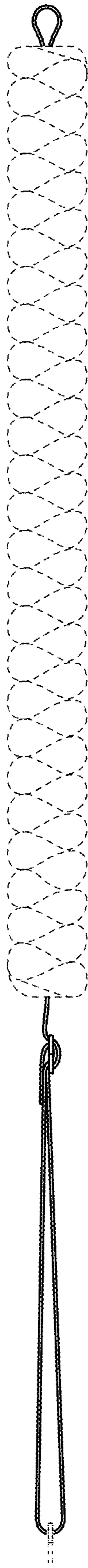

FIG. 5

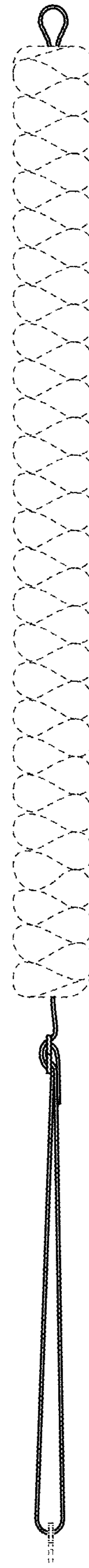

FIG. 6

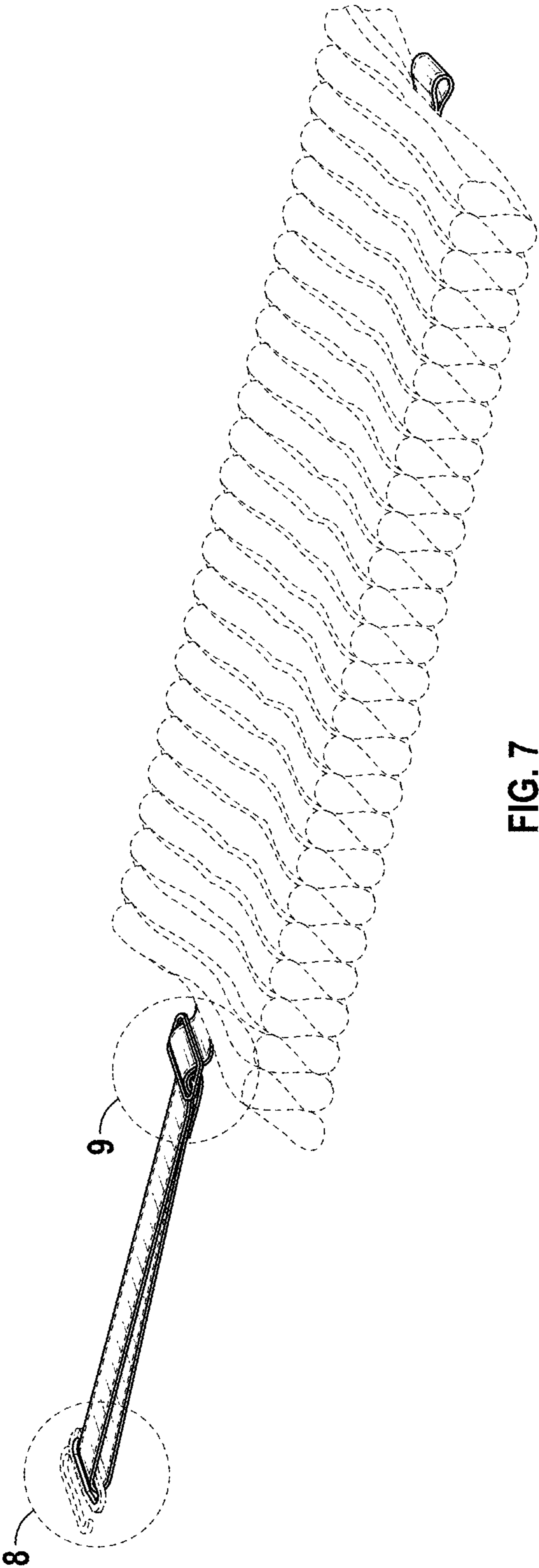

FIG. 7

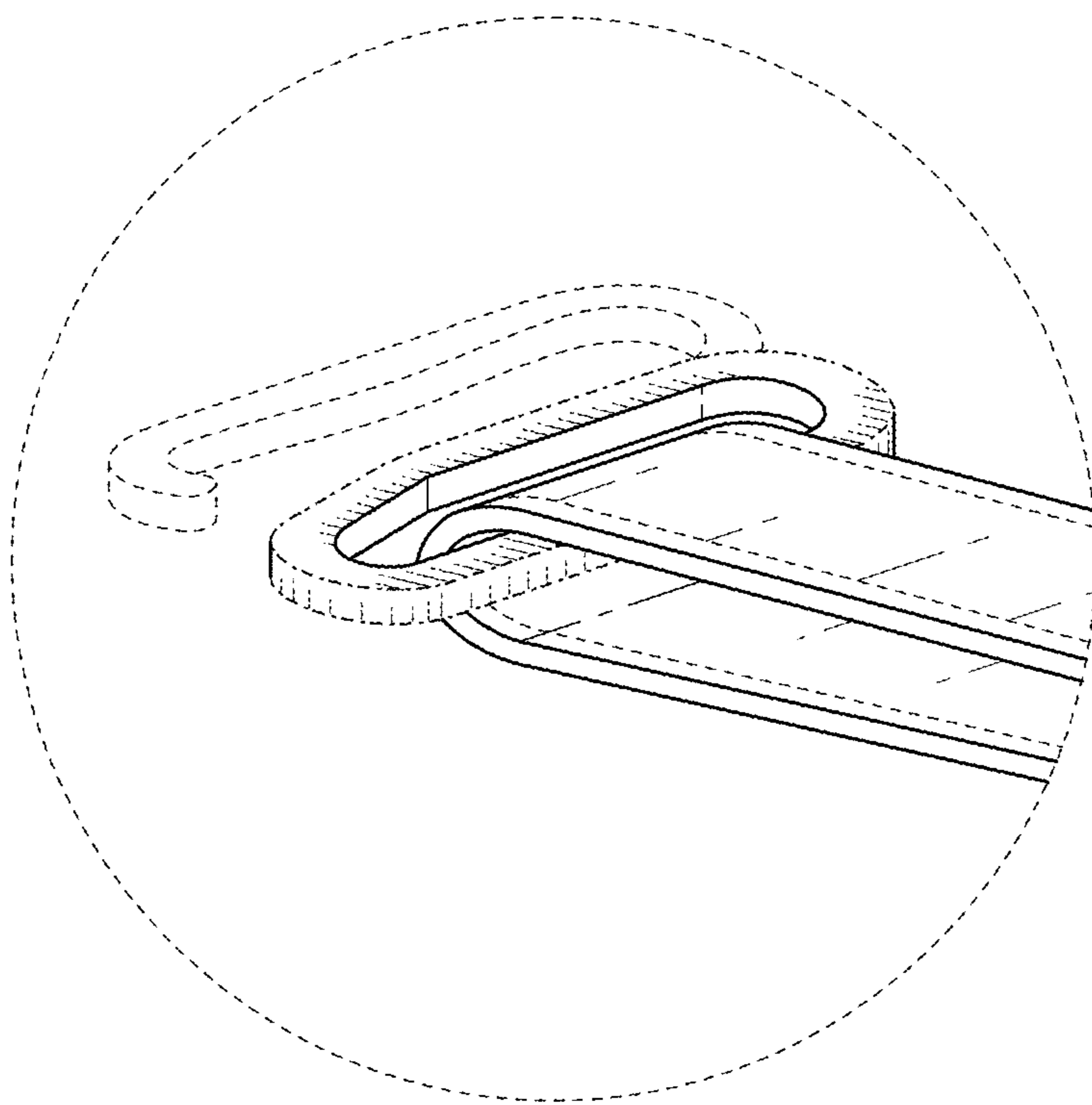

FIG. 8

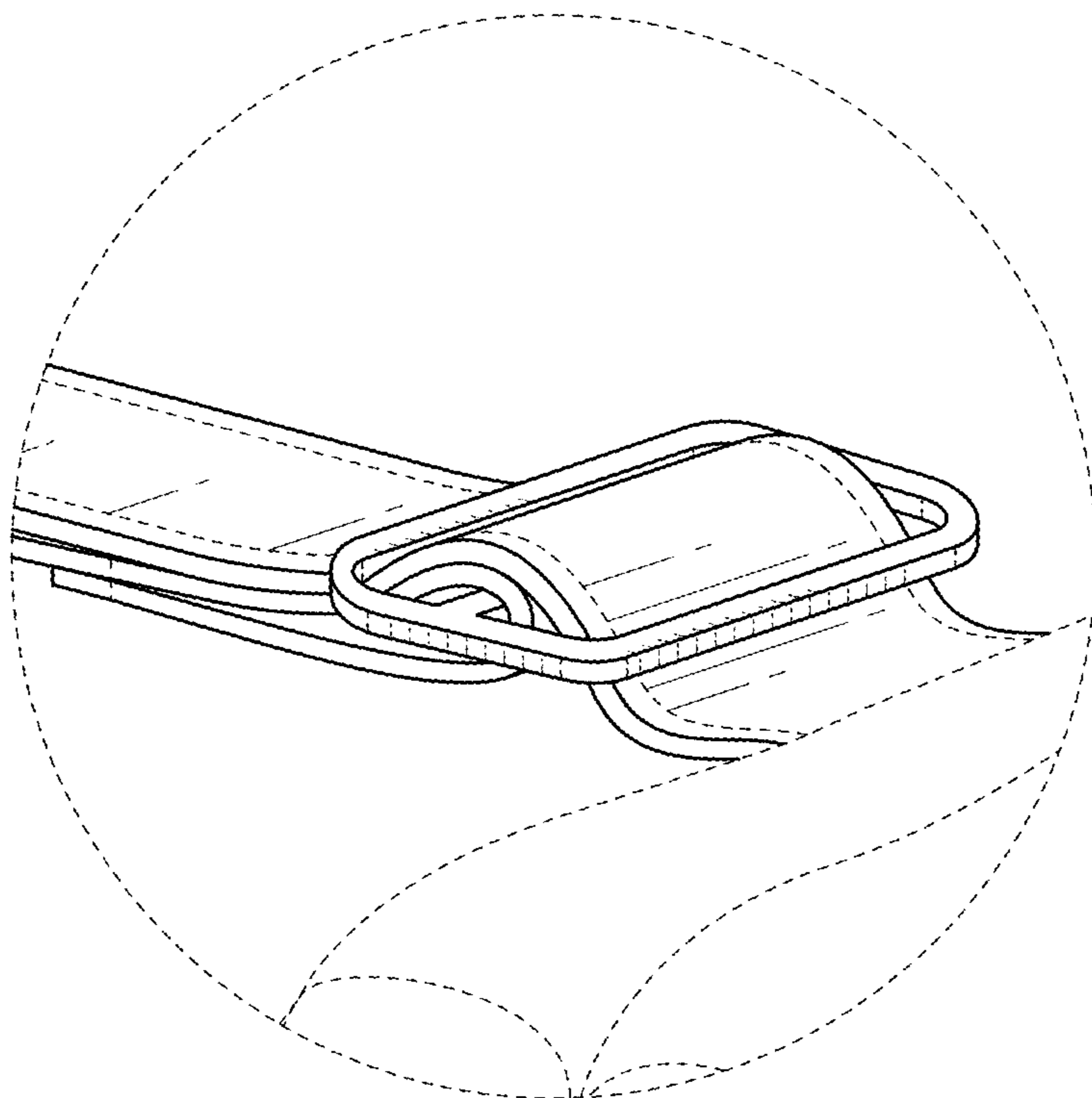

FIG. 9