



US00D878678S

(12) **United States Design Patent**  
**Psimadas et al.**

(10) **Patent No.:** **US D878,678 S**  
(45) **Date of Patent:** **\*\* Mar. 17, 2020**

(54) **SHAVER HANDLE**

(71) Applicant: **Societe BIC**, Clichy (FR)

(72) Inventors: **Ioannis Marios Psimadas**, Athens (GR); **Christoforos Athanasios Brellis**, Athens (GR); **Maria Petratou**, Athens (GR); **Triantafyllia Kottidi**, Athens (GR)

(73) Assignee: **Societe BIC**, Clichy (FR)

(\*\*) Term: **15 Years**

(21) Appl. No.: **29/702,523**

(22) Filed: **Aug. 20, 2019**

**Related U.S. Application Data**

(62) Division of application No. 29/643,344, filed on Apr. 6, 2018.

(30) **Foreign Application Priority Data**

Oct. 10, 2017 (EM) ..... 004393965-0001  
Apr. 5, 2018 (EM) ..... 005204690

(51) **LOC (12) Cl.** ..... **28-03**

(52) **U.S. Cl.**  
USPC ..... **D28/48**

(58) **Field of Classification Search**  
USPC ..... D28/46-48  
CPC ..... B26B 21/00-06; B26B 21/08-227; B26B 21/24-28; B26B 21/30-38; B26B 21/40-4093; B26B 21/52-528  
See application file for complete search history.

(56) **References Cited**

**U.S. PATENT DOCUMENTS**

D495,828 S \* 9/2004 Ham ..... D28/48  
D659,287 S \* 5/2012 Psimadas ..... D28/48

D664,714 S \* 7/2012 Christie ..... D28/48  
D749,784 S \* 2/2016 Go ..... D28/48  
D750,324 S \* 2/2016 Bae ..... D28/48  
D789,609 S \* 6/2017 Kong ..... D28/48  
D792,025 S \* 7/2017 Faktorovich ..... D28/48  
D808,590 S \* 1/2018 Christofidellis ..... D28/48  
D812,815 S \* 3/2018 Psimadas ..... D28/48  
D813,456 S \* 3/2018 Christofidellis ..... D28/48  
D815,354 S \* 4/2018 Psimadas ..... D28/48  
D818,645 S \* 5/2018 Cabrera ..... D28/48

(Continued)

*Primary Examiner* — Jennifer Rivard

(74) *Attorney, Agent, or Firm* — The H.T. Than Law Group

(57) **CLAIM**

We claim the ornamental design for a shaver handle, as shown and described.

**DESCRIPTION**

FIG. 1 is a top perspective view of an ornamental design for a shaver handle according to the present invention; FIG. 2 is an end view thereof; FIG. 3 is the opposite end view thereof; FIG. 4 is a left view thereof; FIG. 5 is a right side view thereof; FIG. 6 is a top view thereof; FIG. 7 is a bottom view thereof; FIG. 8 is a bottom perspective view of another embodiment of the ornamental design for a shaver handle according to the present invention; FIG. 9 is an end view thereof; FIG. 10 is the opposite end view thereof; FIG. 11 is a left view thereof; FIG. 12 is a right side view thereof; FIG. 13 is a top view thereof; and, FIG. 14 is a bottom view thereof. The broken lines illustrate portions of the shaver handle and illustrate contour lines that form no part of the claimed design.

**1 Claim, 8 Drawing Sheets**

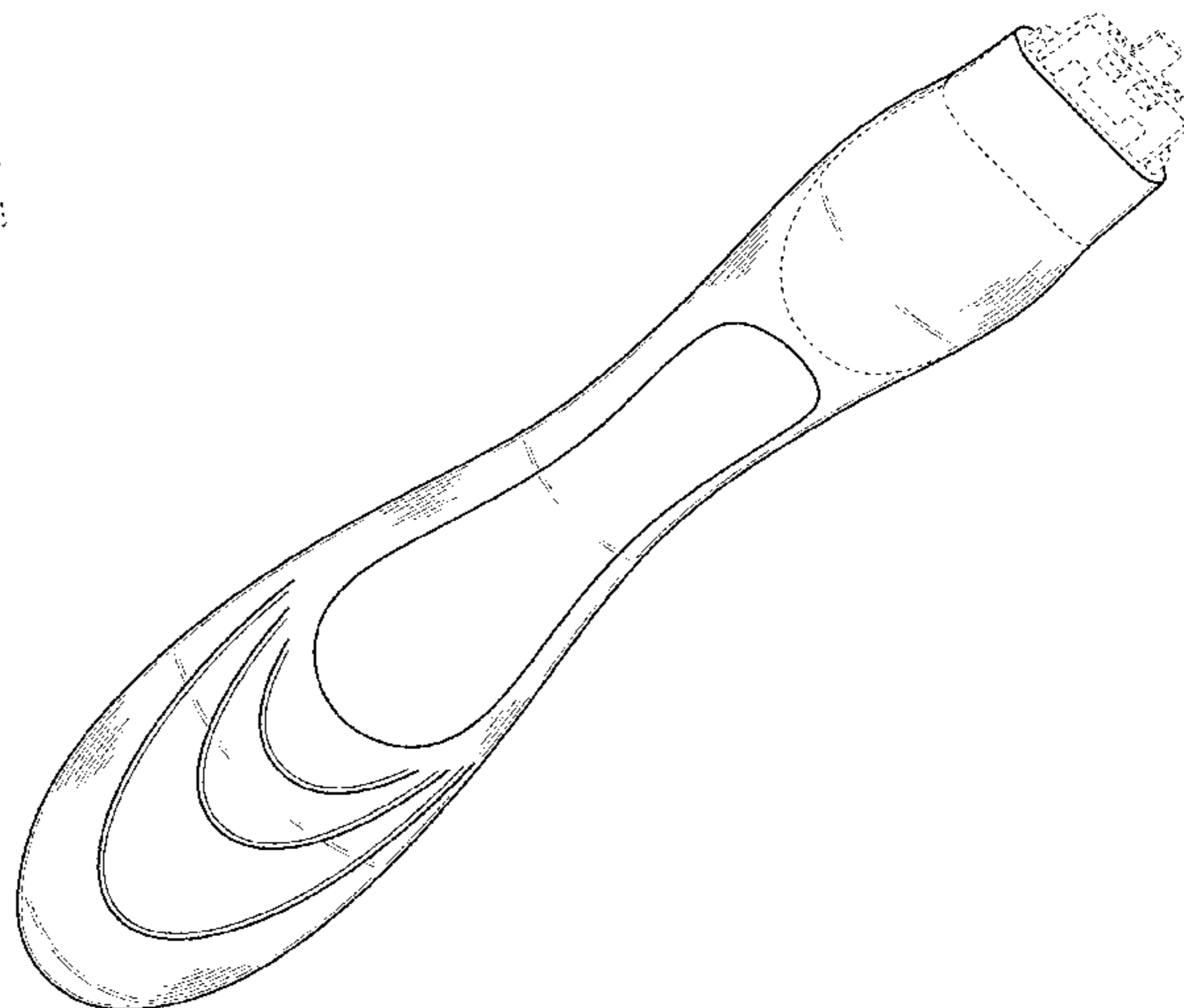
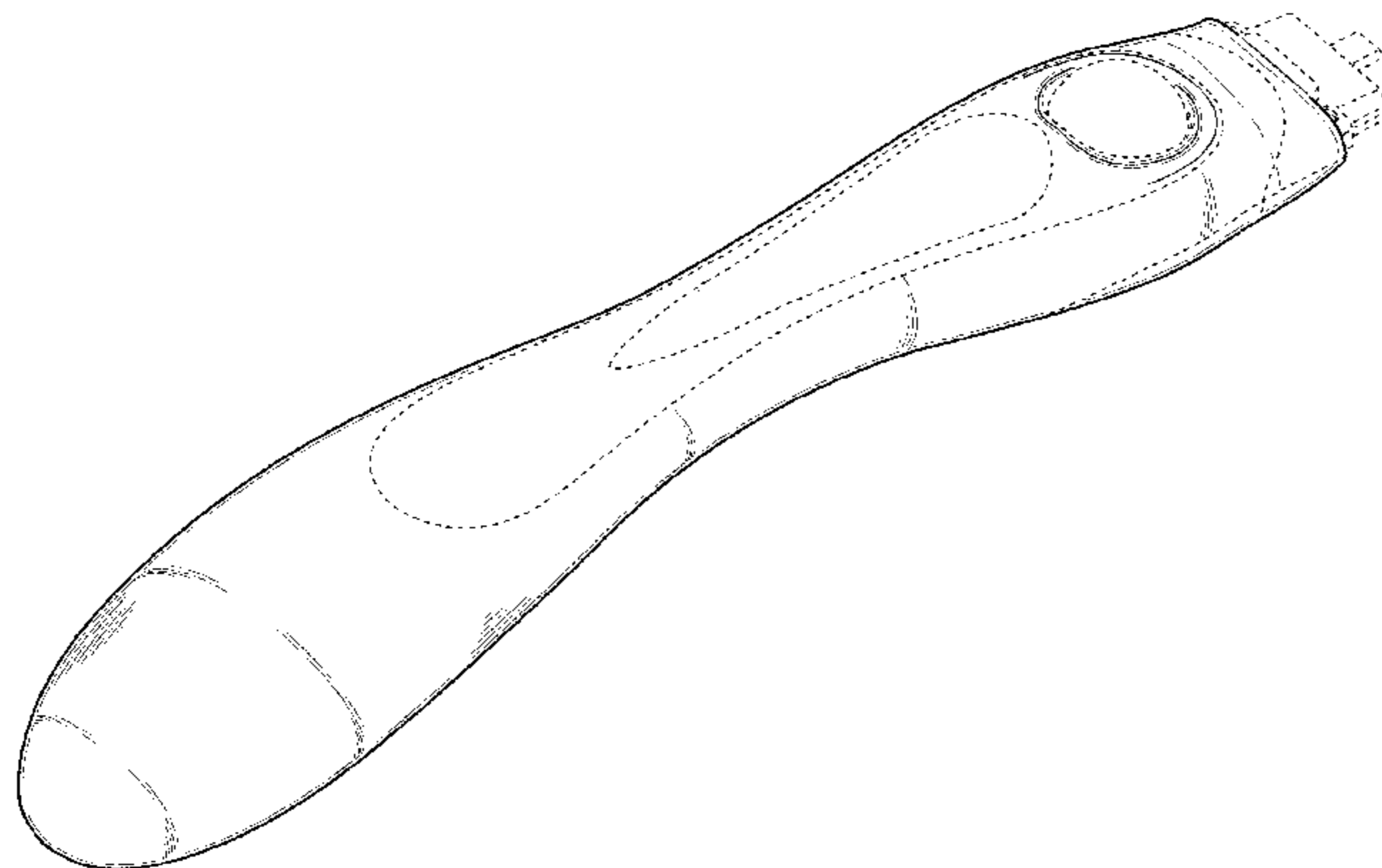

(56)

**References Cited**

U.S. PATENT DOCUMENTS

D837,452 S	*	1/2019	Goeder .....	D28/47
D843,658 S	*	3/2019	Kong .....	D28/48
D861,251 S	*	9/2019	Cabrera .....	D28/46
D863,681 S	*	10/2019	Jin .....	D28/48
D864,482 S	*	10/2019	Goeder .....	D28/48

\* cited by examiner

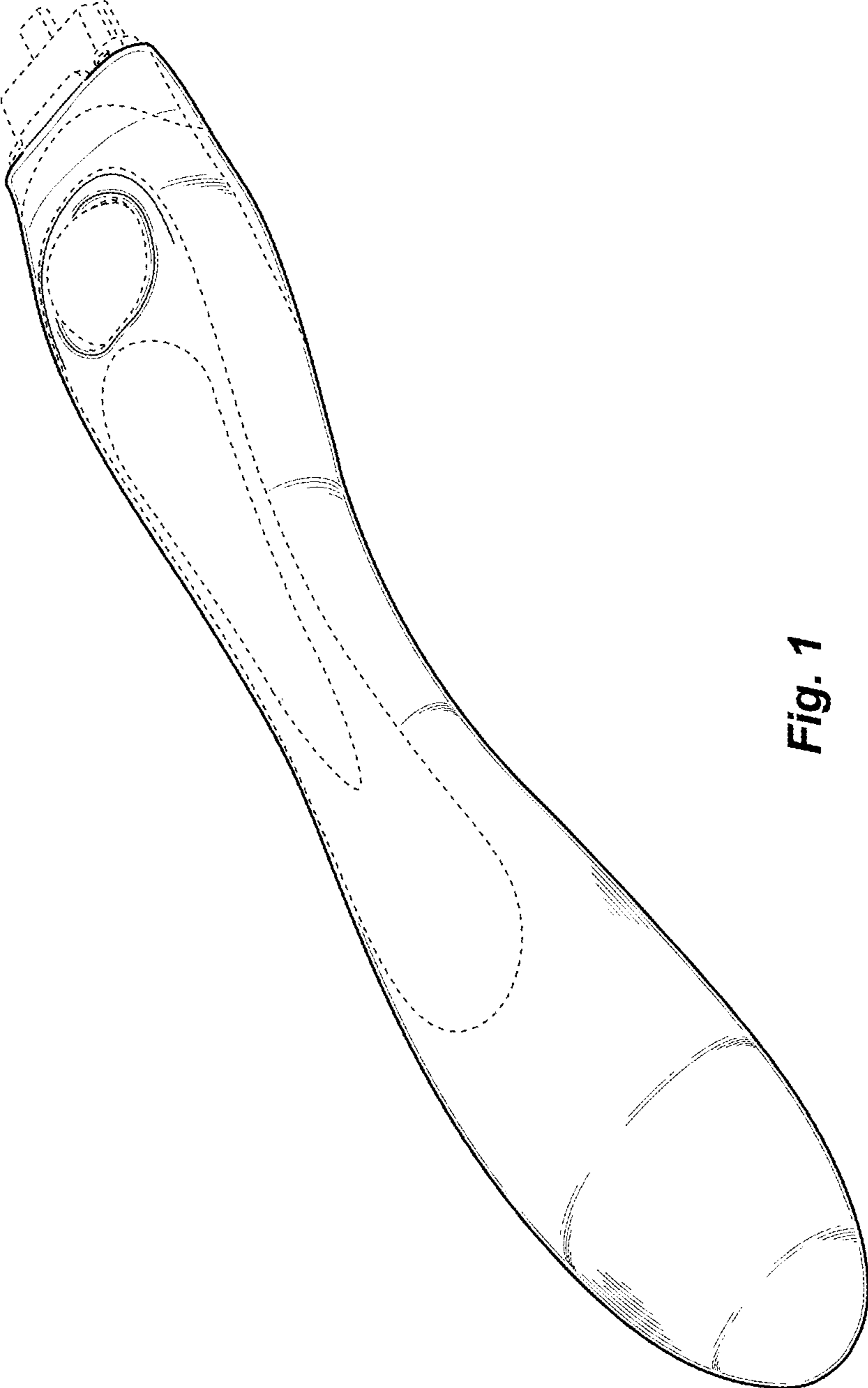

Fig. 1

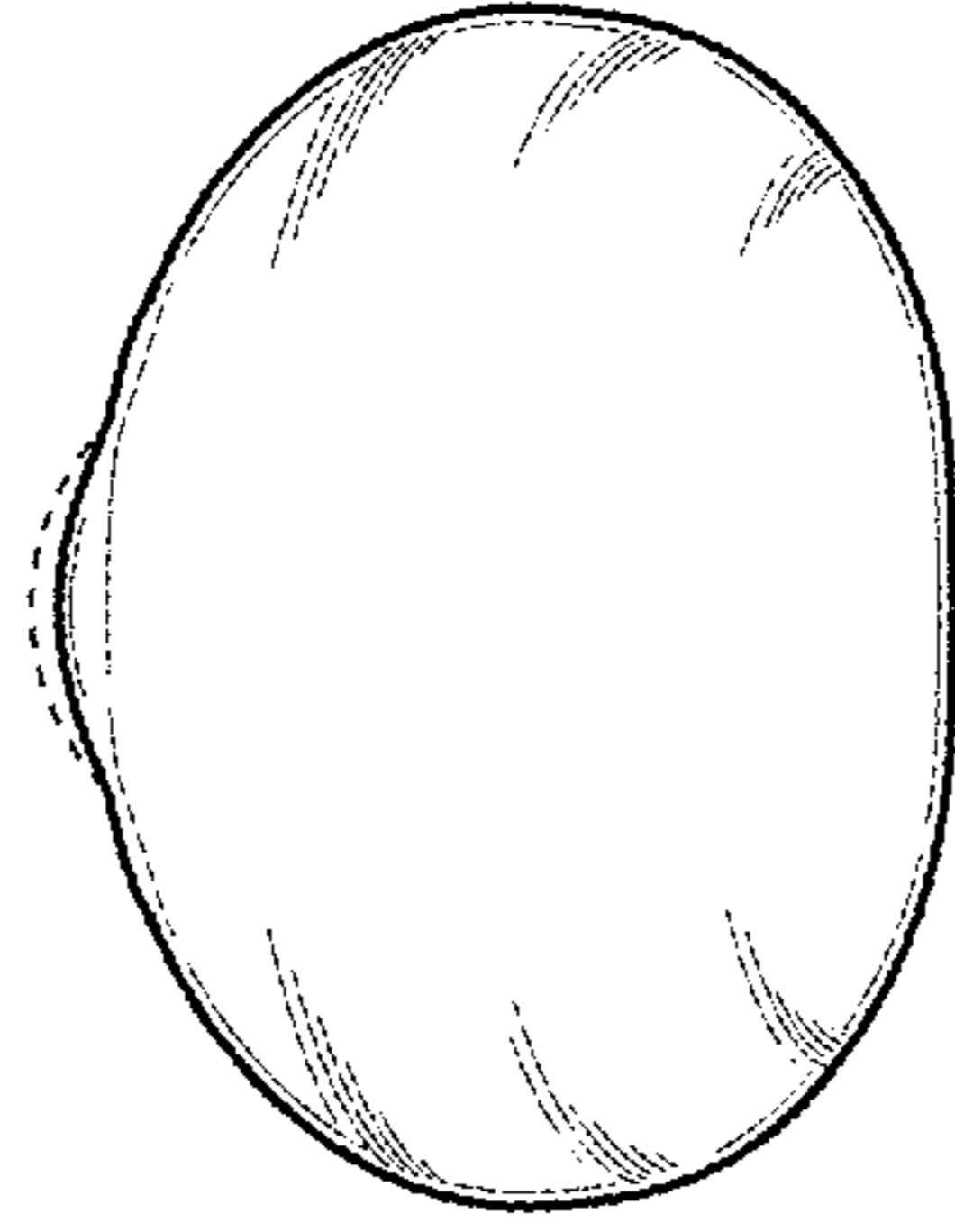

Fig. 3

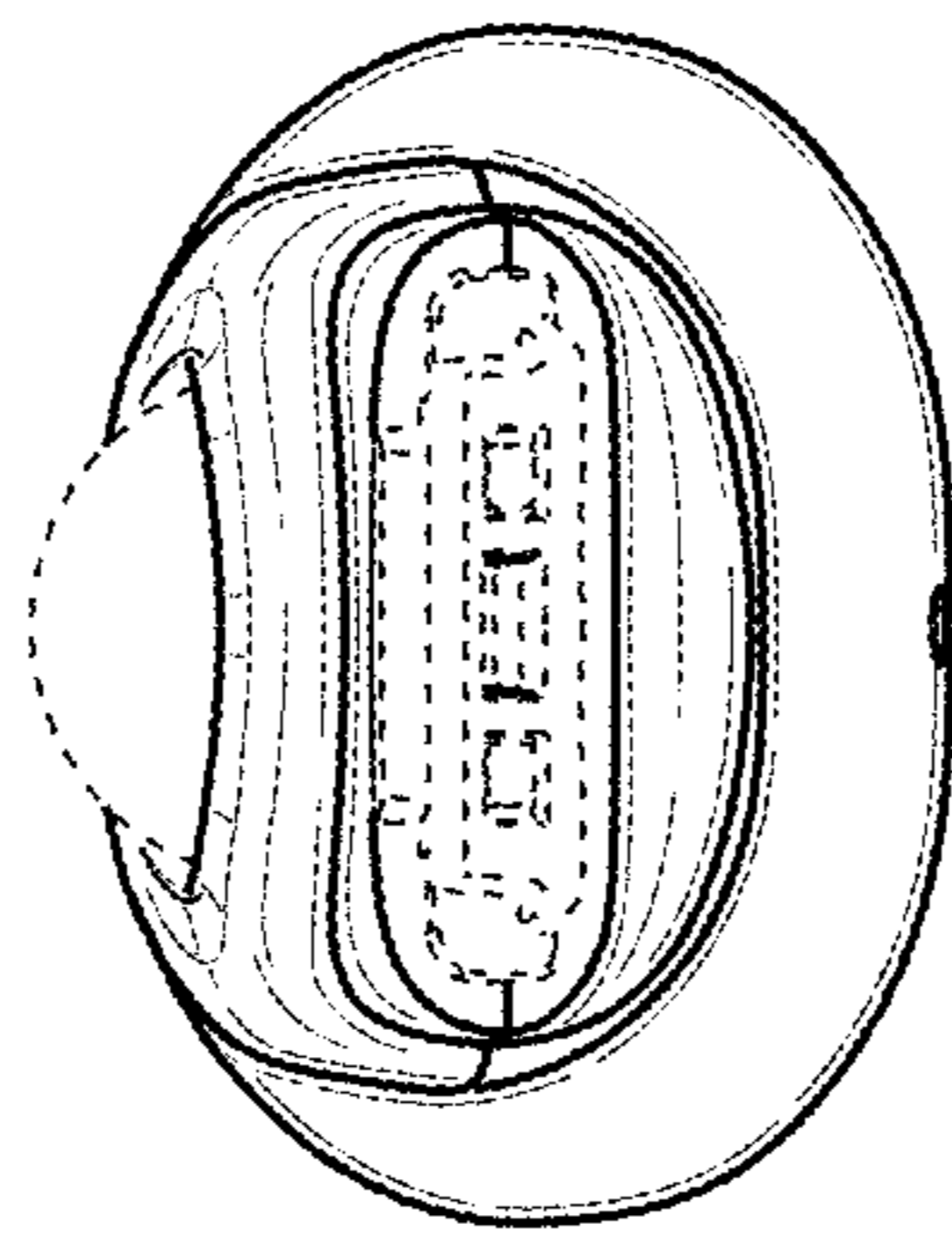
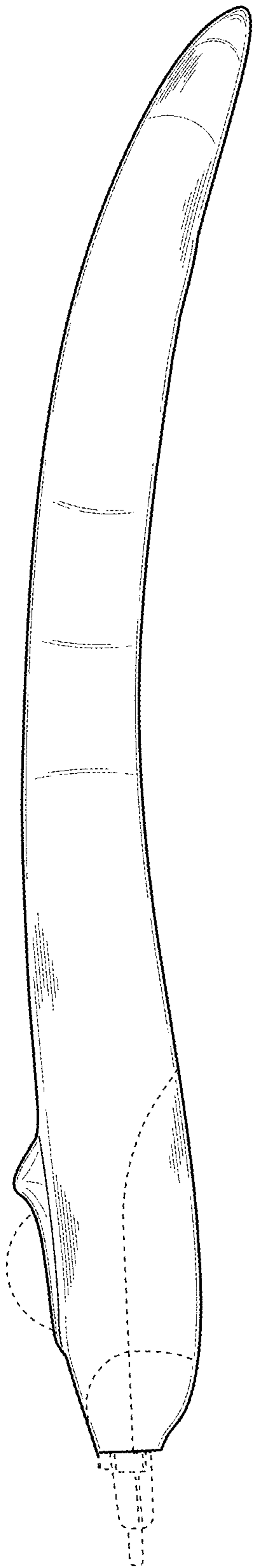
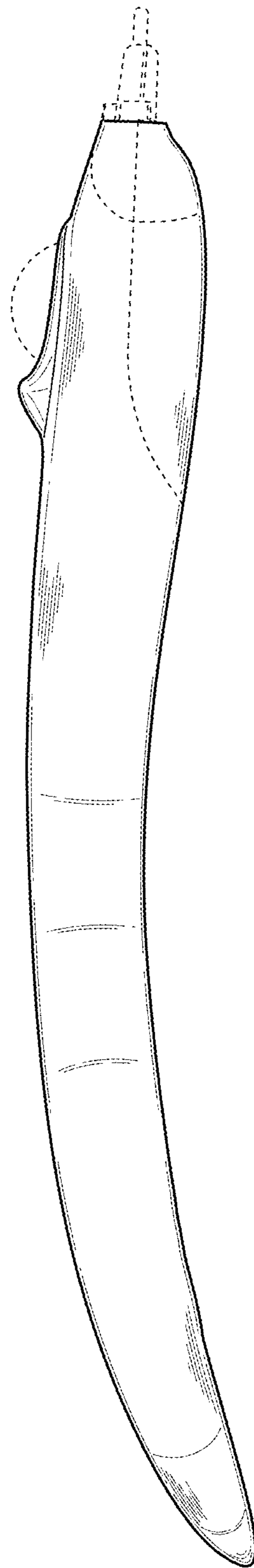

Fig. 2



**Fig. 4**



**Fig. 5**

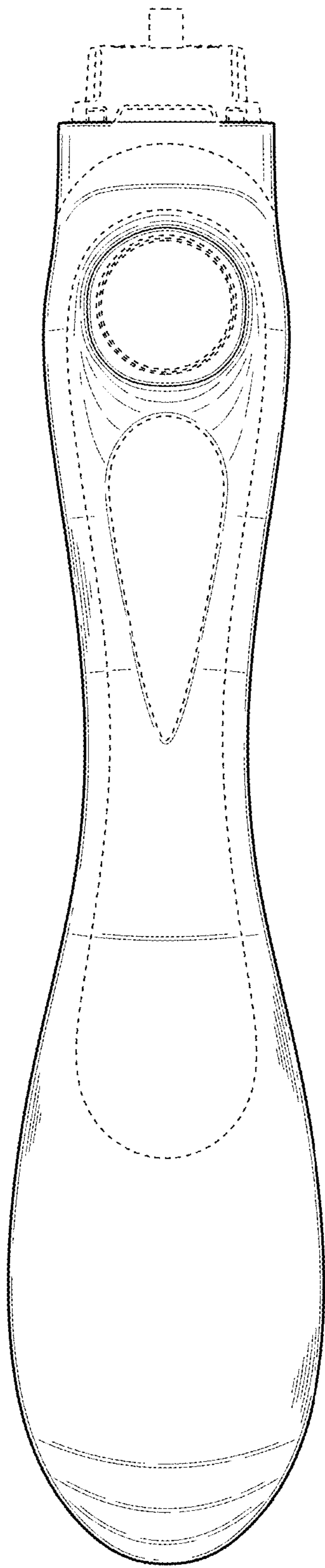

**Fig. 6**

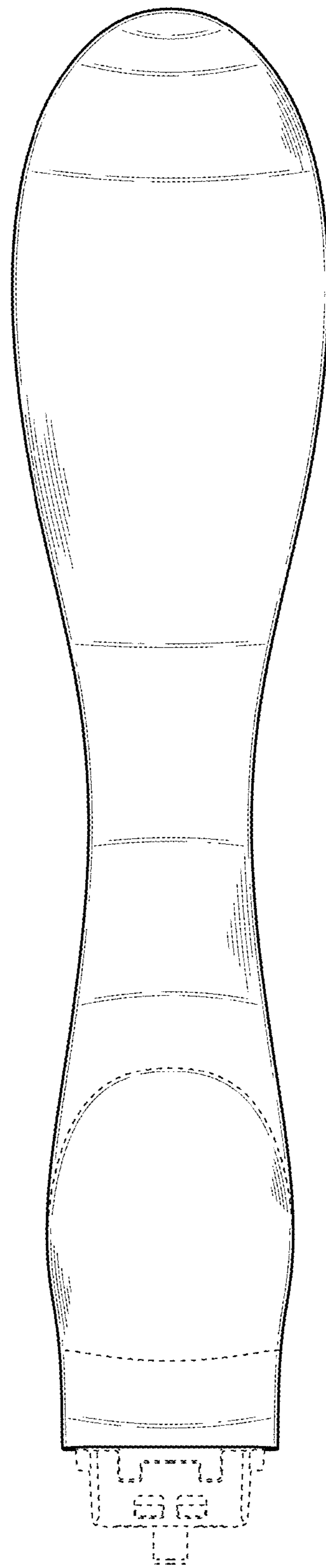

**Fig. 7**

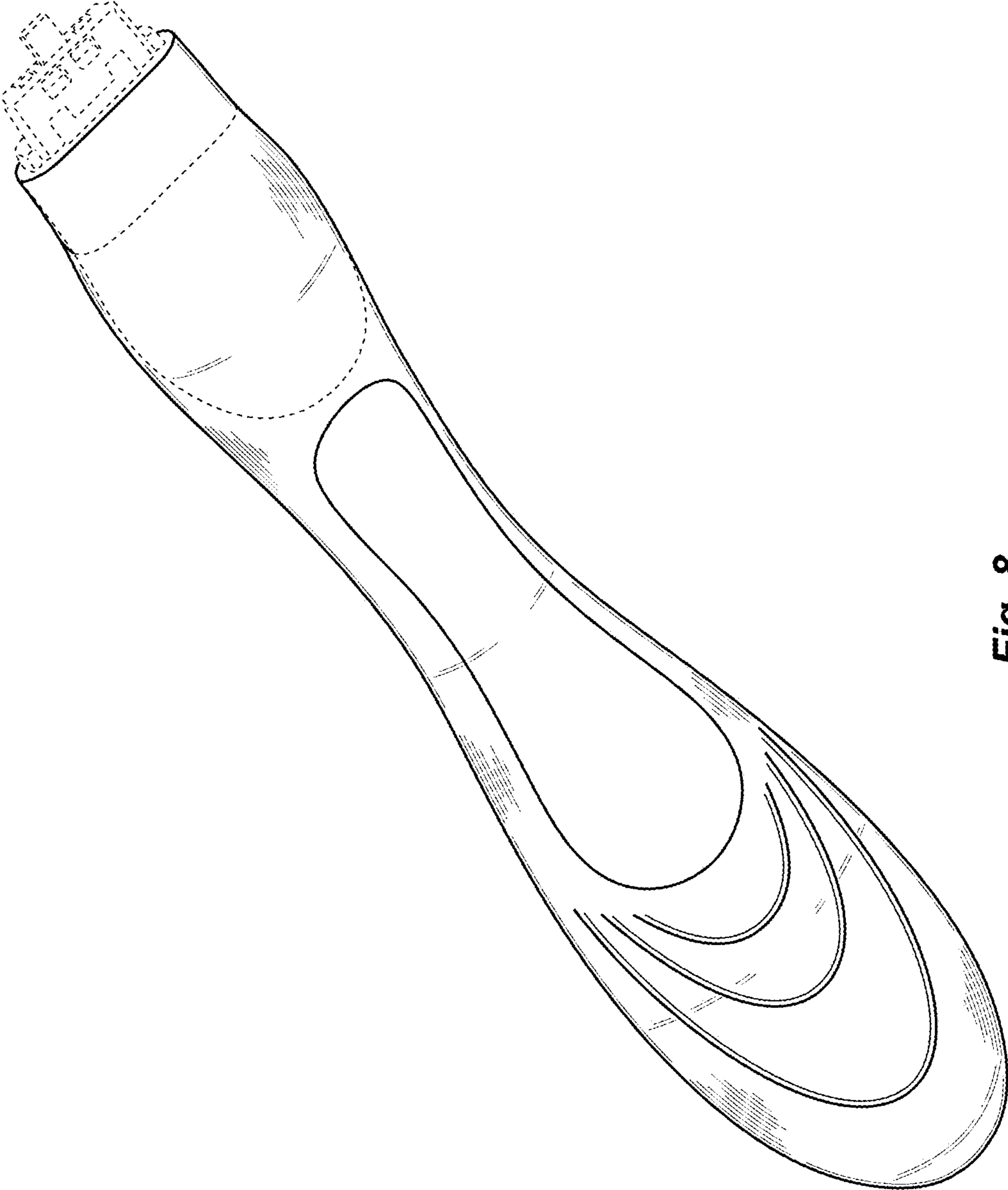
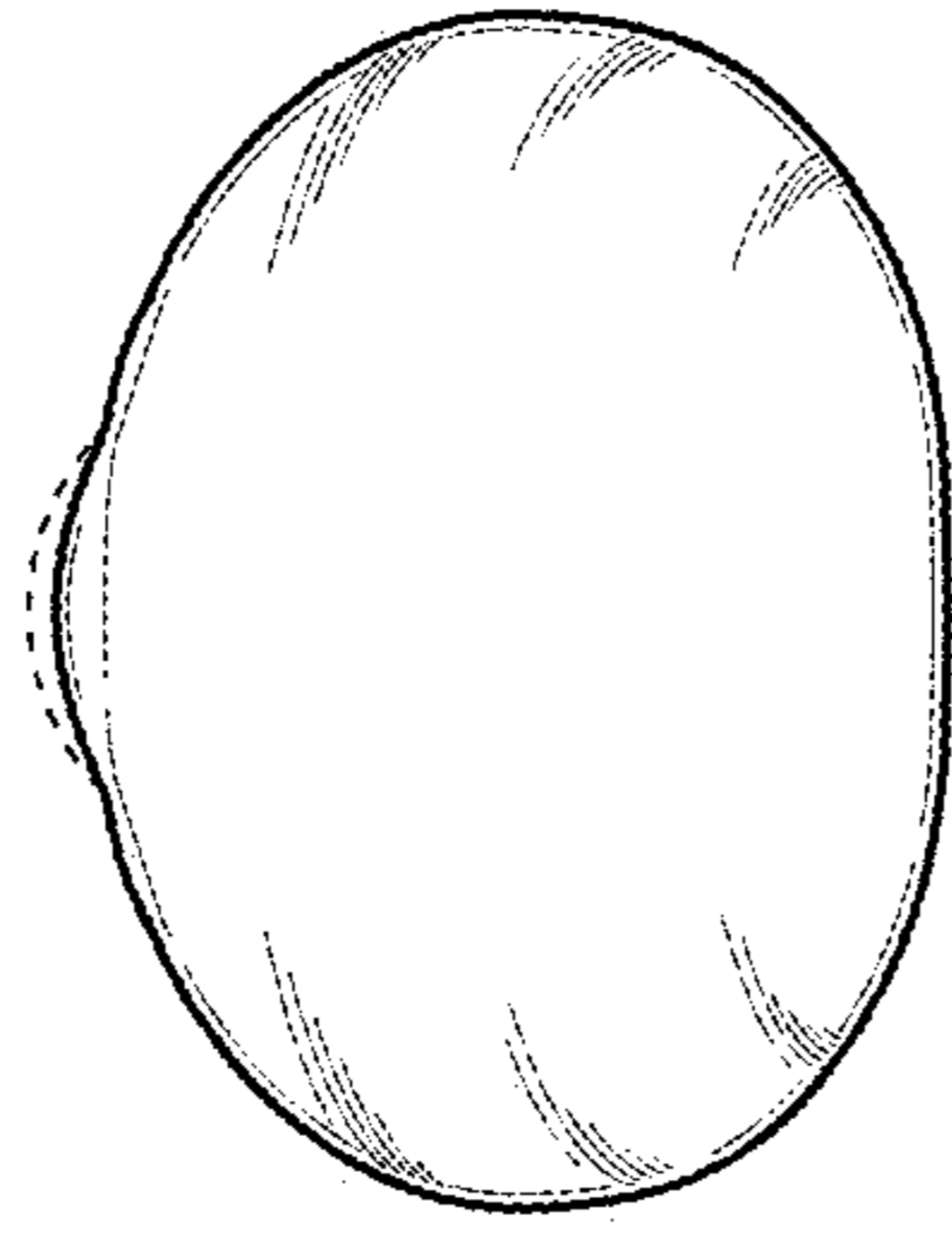
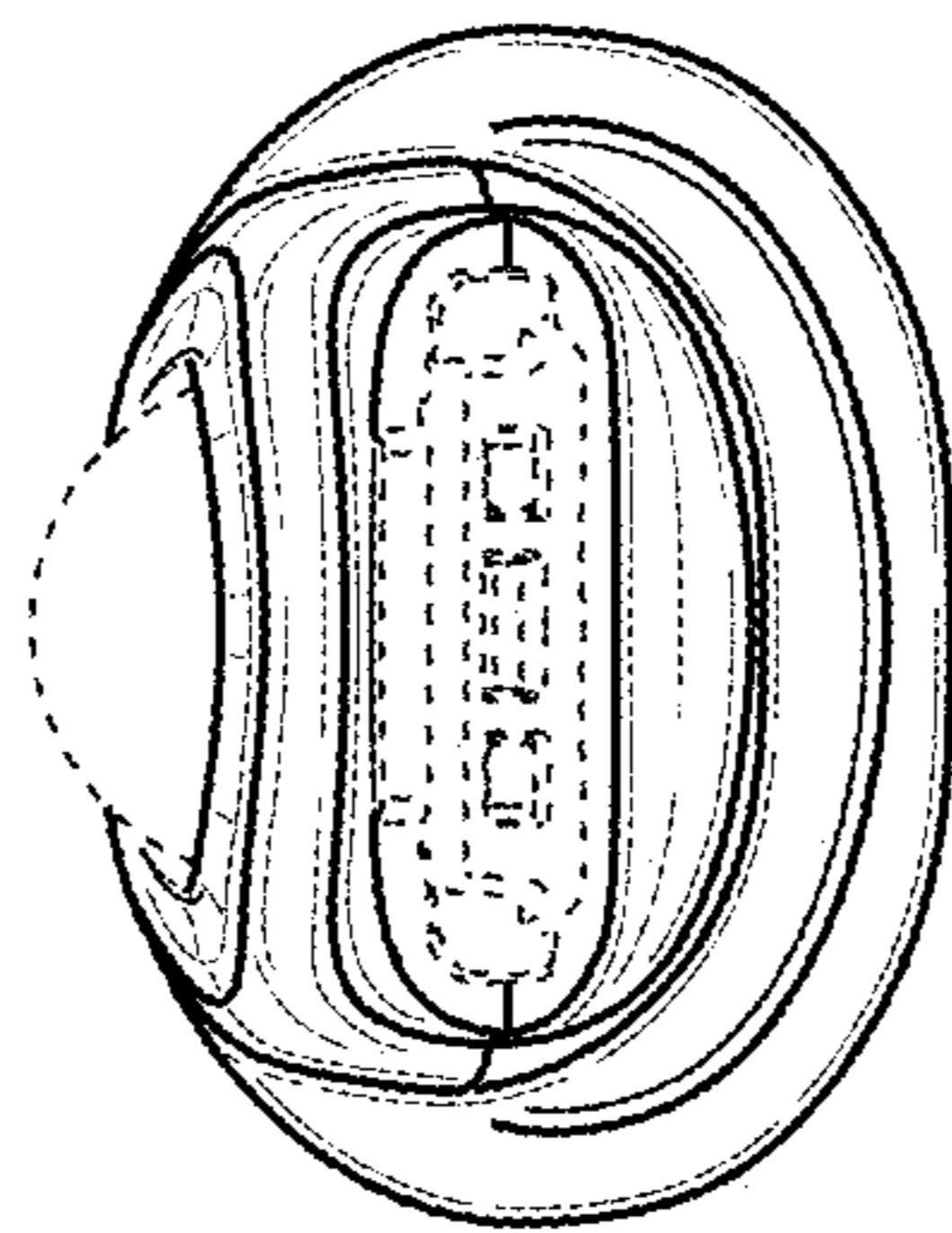

Fig. 8

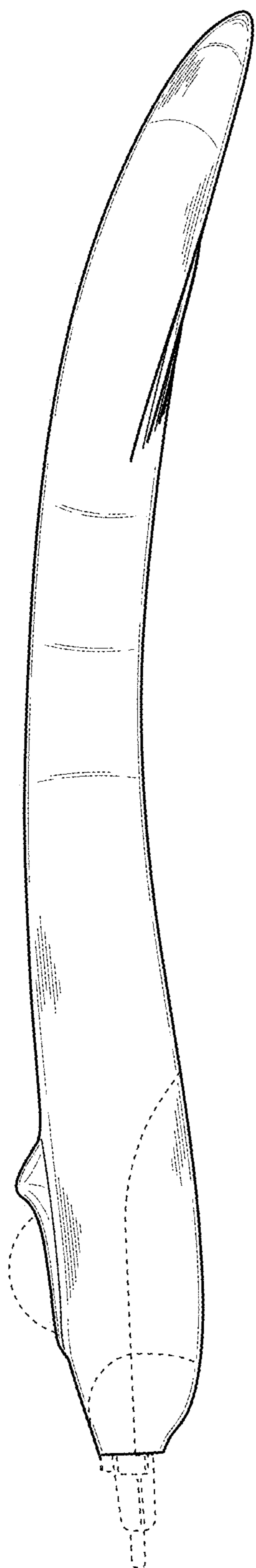

*Fig. 10*

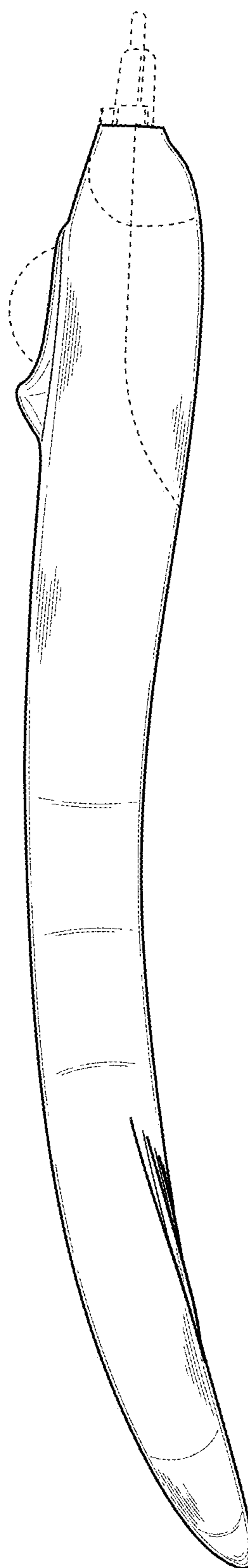

*Fig. 9*

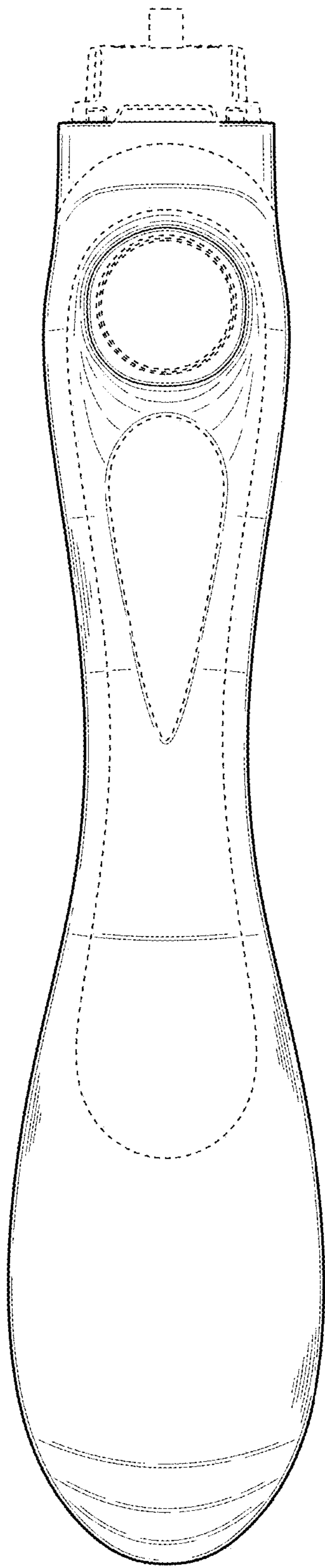



**Fig. 11**



**Fig. 12**



**Fig. 13**

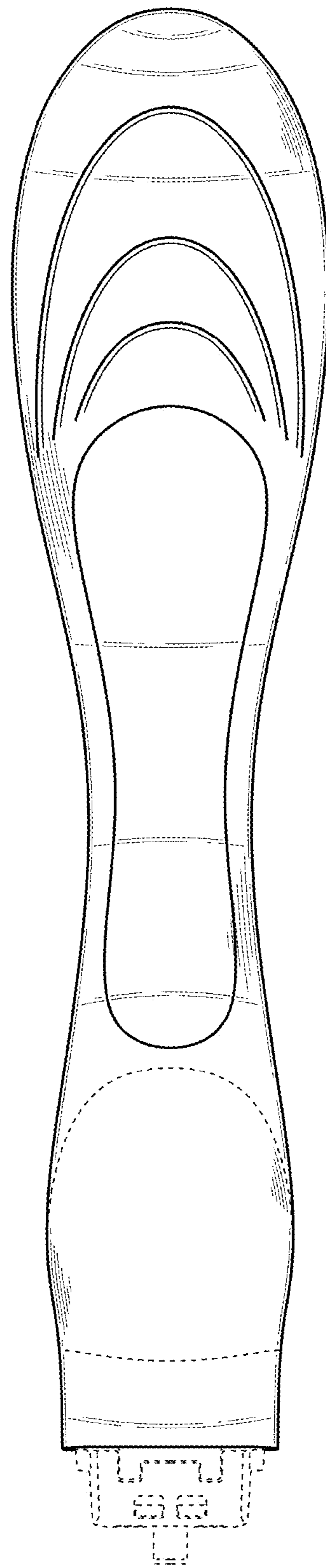

**Fig. 14**