



US00D878663S

(12) **United States Design Patent** (10) **Patent No.:** **US D878,663 S**
Kwon et al. (45) **Date of Patent:** **** Mar. 17, 2020**

(54) **DIGITAL SIGN**
(71) Applicant: **LG ELECTRONICS INC.**, Seoul (KR)
(72) Inventors: **Areum Kwon**, Seoul (KR); **Sechang Park**, Seoul (KR); **Yongho Lee**, Seoul (KR)

D185,082 S * 5/1959 Hutchens 40/502
D185,874 S * 8/1959 Rambusch et al. D26/88
D599,947 S * 9/2009 Sabernig D26/88
D643,957 S * 8/2011 Verelst D26/65
D665,121 S * 8/2012 Smith D26/128
8,256,151 B2 * 9/2012 Stafford G09F 7/18
40/606.12

(73) Assignee: **LG ELECTRONICS INC.**, Seoul (KR)

(**) Term: **15 Years**

(21) Appl. No.: **35/505,085**

(22) Filed: **Dec. 6, 2017**

(80) **Hague Agreement Data**

Int. Filing Date: **Dec. 6, 2017**
Int. Reg. No.: **DM/098988**
Int. Reg. Date: **Dec. 6, 2017**
Int. Reg. Pub. Date: **Jun. 8, 2018**

(30) **Foreign Application Priority Data**

Jun. 7, 2017 (KR) 30-2017-0025803

(51) **LOC (12) Cl.** **26-05**

(52) **U.S. Cl.**
USPC **D26/88**

(58) **Field of Classification Search**
USPC D20/10, 18, 19, 21, 42, 99; D14/127,
D14/373; D26/72, 81, 84, 88, 93, 95
CPC ... G09F 7/00; G09F 7/02; G09F 13/04; G09F
19/02

See application file for complete search history.

(56) **References Cited**

U.S. PATENT DOCUMENTS

D81,468 S * 6/1930 Simpson D20/10
2,830,395 A * 4/1958 Hutchens G09F 11/02
40/473

OTHER PUBLICATIONS

Screenshot from Youtube.com: Firstlook : LG Introduces India'S First Display 'Signage' with flexible 70 curved LG OLED panels. Dated Aug. 2, 2017. Found online Apr. 11, 2019 at: <https://www.youtube.com/watch?v=cH-0SLNcQnl>.*

* cited by examiner

Primary Examiner — Robert M. Spear
(74) *Attorney, Agent, or Firm* — Birch, Stewart, Kolasch & Birch, LLP

(57) **CLAIM**

The ornamental design for a digital sign, as shown and described.

DESCRIPTION

- 1. Digital sign
- 1.1 : Perspective
- 1.2 : Front
- 1.3 : Back
- 1.4 : Left
- 1.5 : Right
- 1.6 : Top
- 1.7 : Bottom

The broken lines indicate unclaimed portions of the digital sign that form no part of the claimed design.

1 Claim, 6 Drawing Sheets

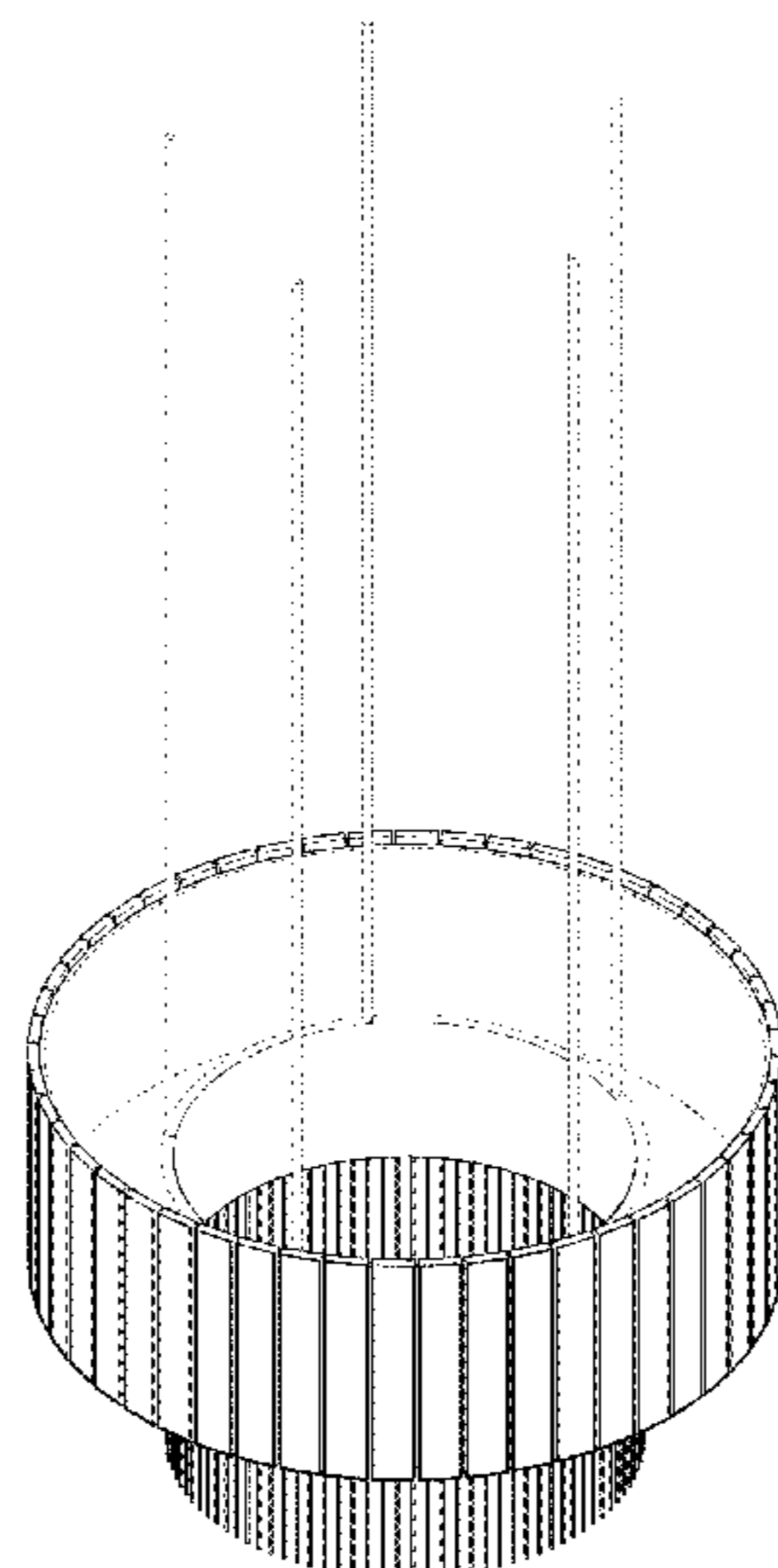

1.1

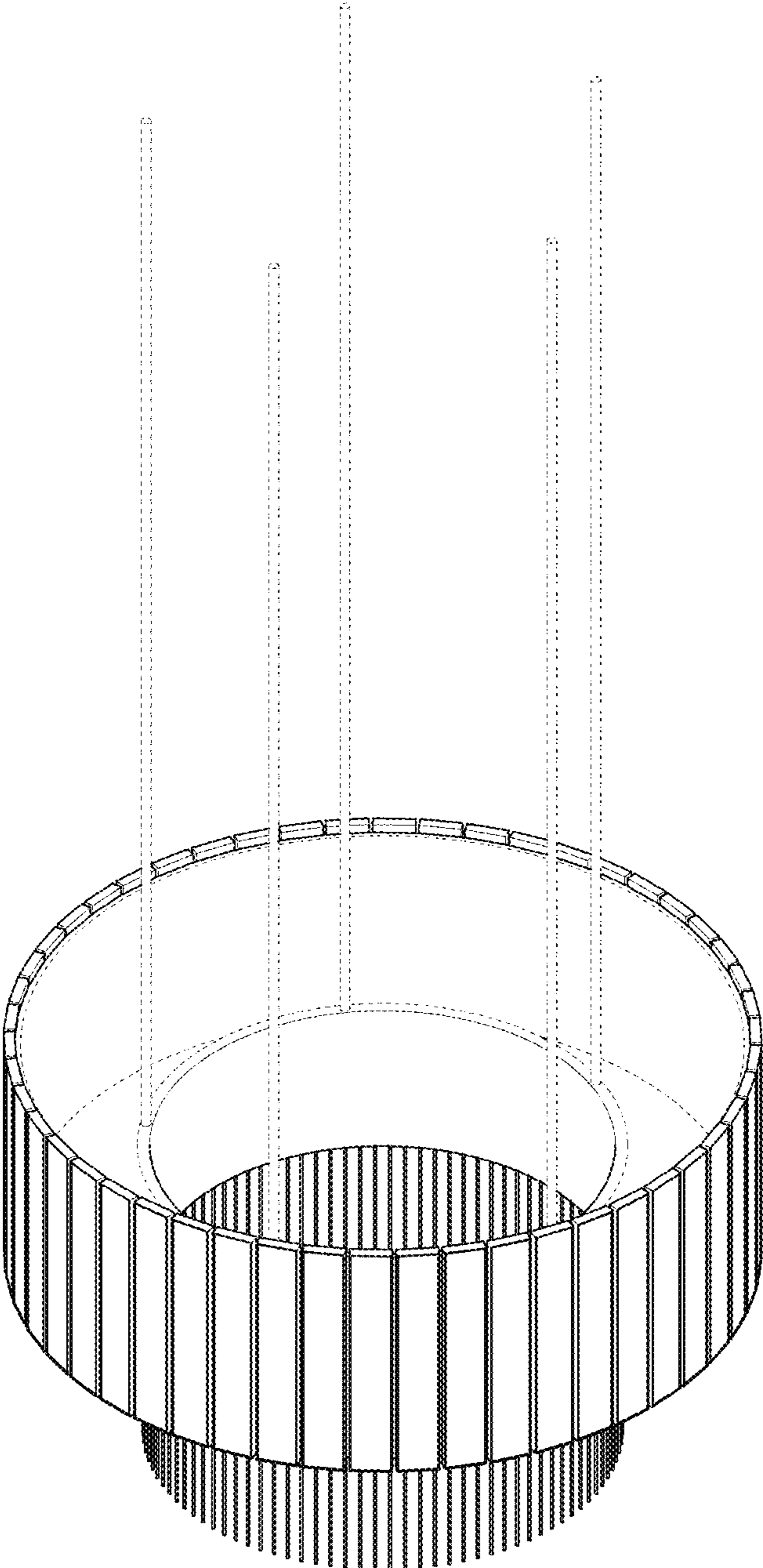

1.2

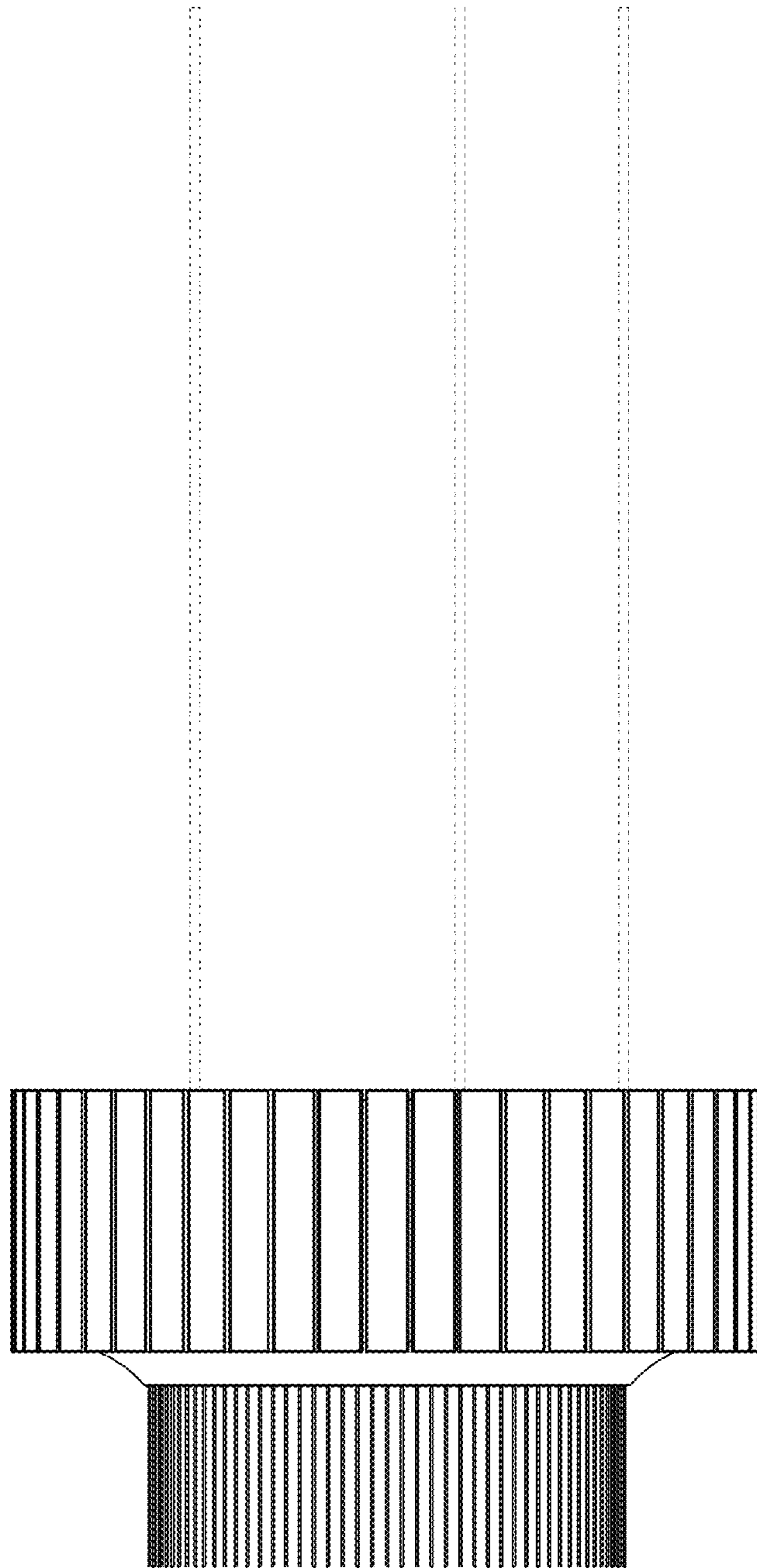

1.3

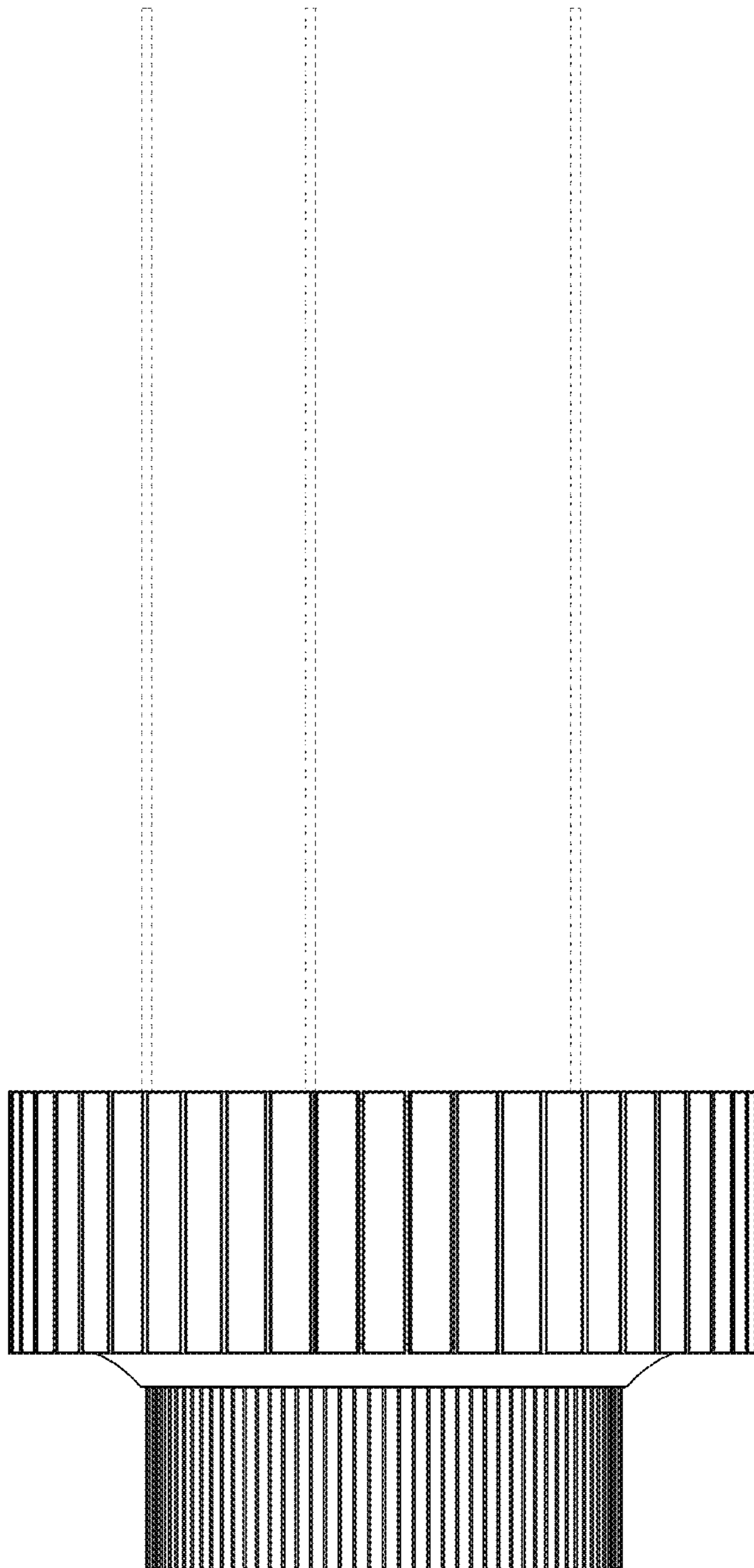

1.4

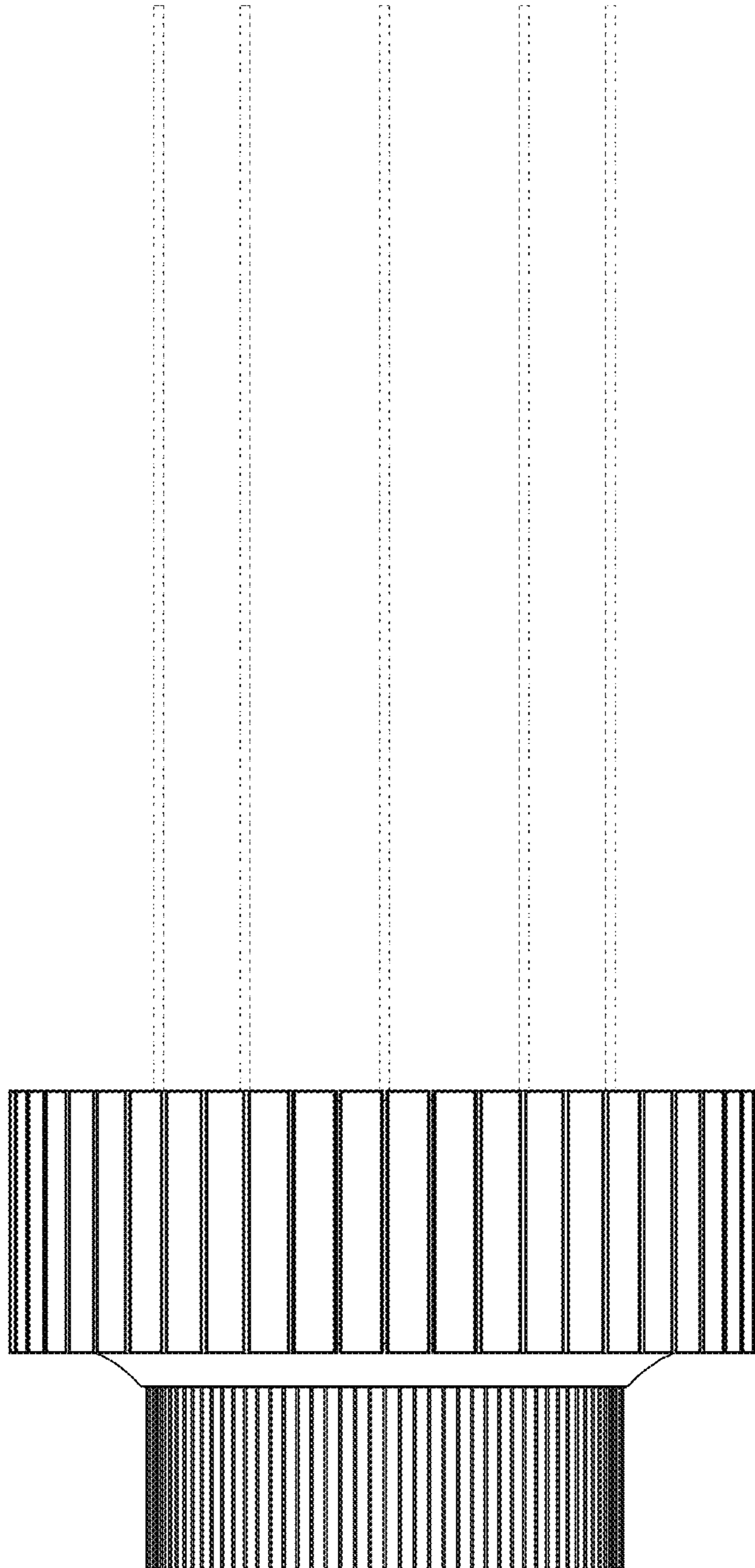

1.5

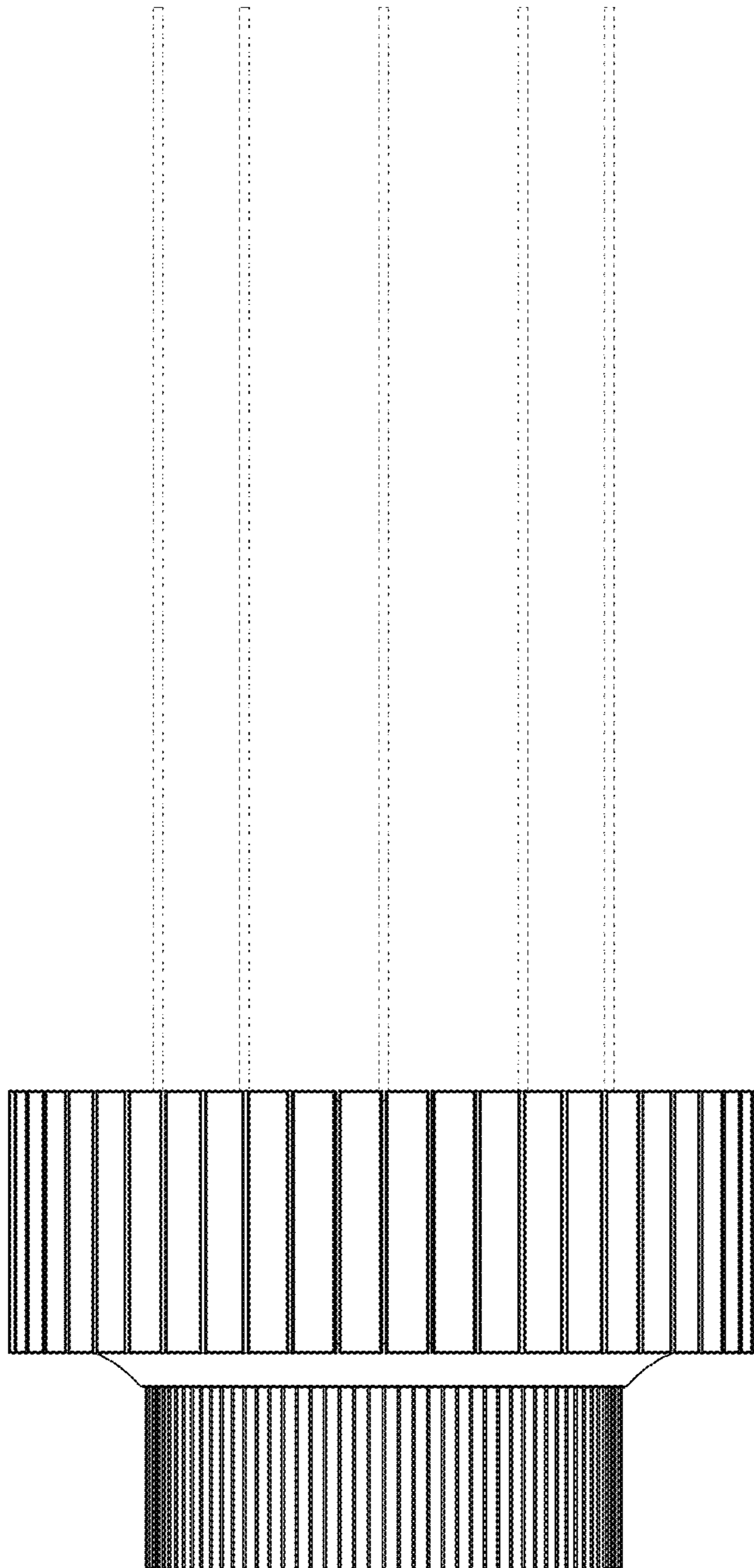

1.6

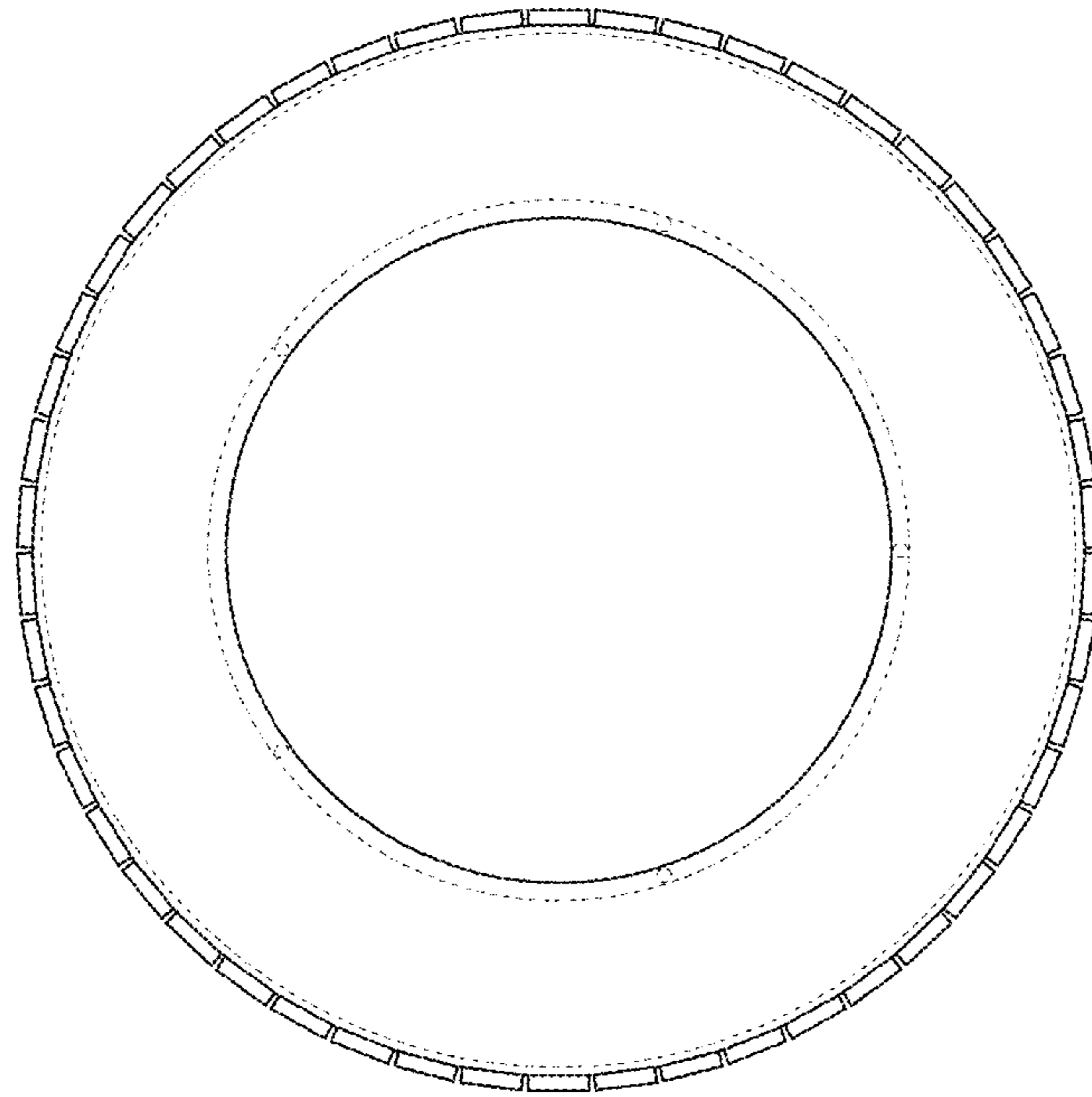

1.7

