



US00D878581S

(12) **United States Design Patent**  
**Sato et al.**

(10) **Patent No.:** **US D878,581 S**  
(45) **Date of Patent:** **\*\* Mar. 17, 2020**

(54) **IMAGING APPARATUS FOR AN ENDOSCOPE**

(71) Applicant: **FUJIKURA LTD.**, Tokyo (JP)

(72) Inventors: **Takao Sato**, Chiba (JP); **Katsuyoshi Endoh**, Chiba (JP); **Hideo Shiratani**, Chiba (JP); **Kengo Takamizawa**, Chiba (JP)

(73) Assignee: **Fujikura Ltd.**, Tokyo (JP)

(\*\*) Term: **15 Years**

(21) Appl. No.: **29/665,482**

(22) Filed: **Oct. 3, 2018**

(30) **Foreign Application Priority Data**

Apr. 4, 2018 (JP) ..... 2018-007424

(51) **LOC (12) Cl.** ..... **24-02**

(52) **U.S. Cl.**  
USPC ..... **D24/138**

(58) **Field of Classification Search**  
USPC ..... D24/138, 135, 140, 108, 113, 127, 133, D24/137; 600/131, 132, 145-147; 604/19, 48, 115, 164.01-164.09, 168.01, 604/187, 192, 93.01, 232, 272, 523, 524, 604/526, 533  
CPC ..... A61B 1/267; A61B 1/2673; A61B 1/2676; A61B 1/00; A61B 1/00052; A61B 1/00066; A61B 5/0077; A61B 19/5223; A61B

(Continued)

(56) **References Cited**

**U.S. PATENT DOCUMENTS**

D698,730 S \* 2/2014 Hori ..... D13/146  
D755,378 S \* 5/2016 Dejima ..... D24/138

(Continued)

*Primary Examiner* — Wan Laymon

*Assistant Examiner* — Mark Booker

(74) *Attorney, Agent, or Firm* — Osha Liang LLP

(57) **CLAIM**

The ornamental design for an imaging apparatus for an endoscope, as shown and described.

**DESCRIPTION**

FIG. 1 is a perspective view of the imaging apparatus for an endoscope;

FIG. 2 is a front view of the imaging apparatus for an endoscope of FIG. 1;

FIG. 3 is a rear view of the imaging apparatus for an endoscope of FIG. 1;

FIG. 4 is a top view of the imaging apparatus for an endoscope of FIG. 1;

FIG. 5 is a bottom view of the imaging apparatus for an endoscope of FIG. 1;

FIG. 6 is an enlarged perspective view of the imaging apparatus for an endoscope of FIG. 1 taken along line A-A in FIG. 1;

FIG. 7 is an enlarged top view of the imaging apparatus for an endoscope of FIG. 1 taken along line B-B in FIG. 2;

FIG. 8 is an enlarged left side view of the imaging apparatus for an endoscope of FIG. 1;

FIG. 9 is an enlarged right side view of the imaging apparatus for an endoscope of FIG. 1; and,

FIG. 10 is a perspective view of the imaging apparatus for an endoscope of FIG. 1 showing the imaging apparatus for an endoscope in a bending state.

The shade lines on the surfaces of the imaging apparatus for an endoscope show contour and not surface ornamentation. The broken lines showing portions of the imaging apparatus for an endoscope depict the environmental structure and form no part of the claimed design.

The dashed dot dash broken away symbols in the drawings indicate that any portion of the article beyond what is shown forms no part of the claimed design.

**1 Claim, 6 Drawing Sheets**

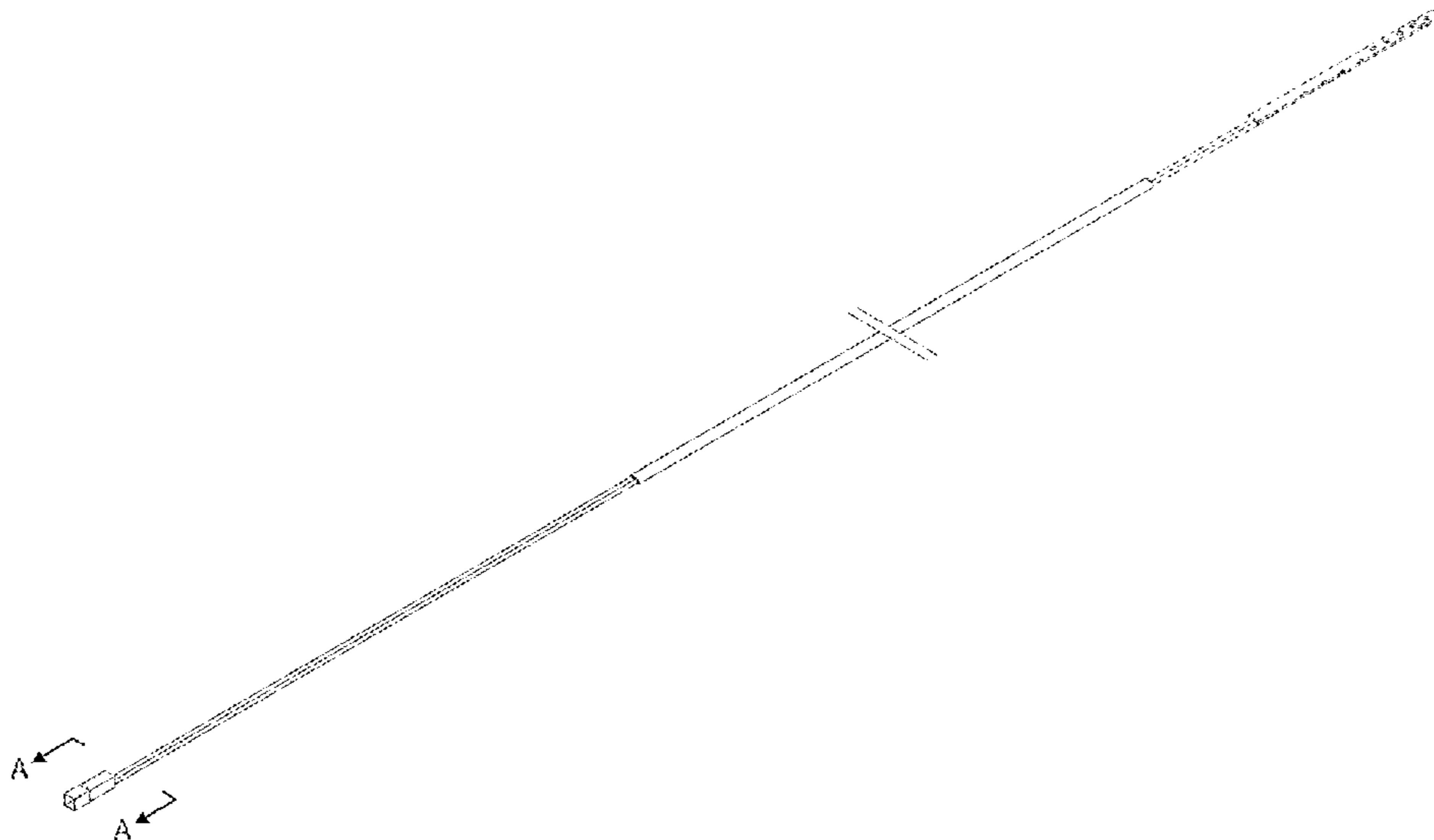

(58) **Field of Classification Search**

CPC ..... 19/5225; A61B 1/04; A61B 8/5215; A61B  
1/00126; G02B 23/24

See application file for complete search history.

(56) **References Cited**

U.S. PATENT DOCUMENTS

D822,827 S *	7/2018	Hosogoe .....	D24/127
D827,131 S *	8/2018	Hayamizu .....	D24/129
D859,657 S *	9/2019	Ostrovsky .....	D24/138

\* cited by examiner

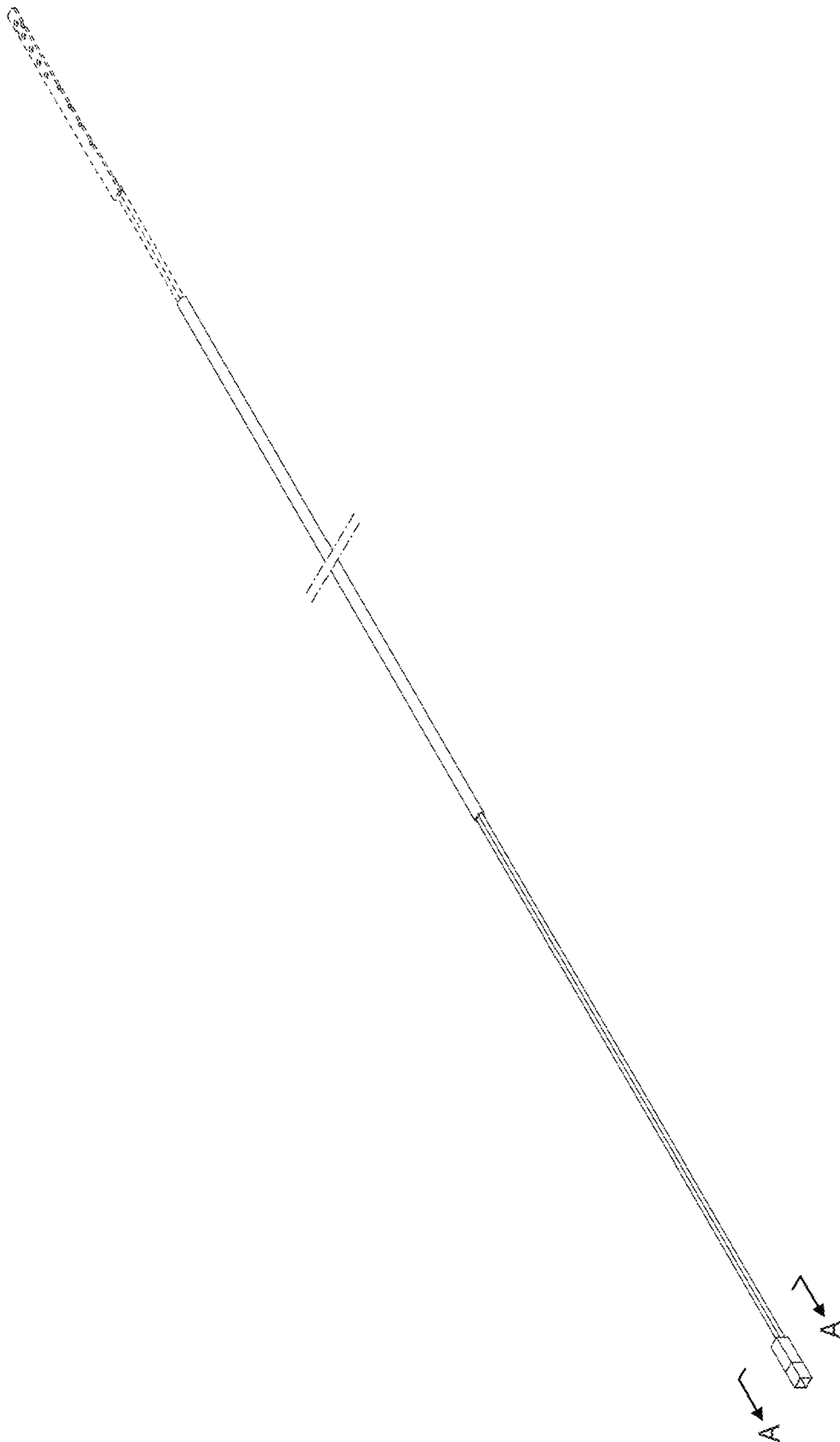
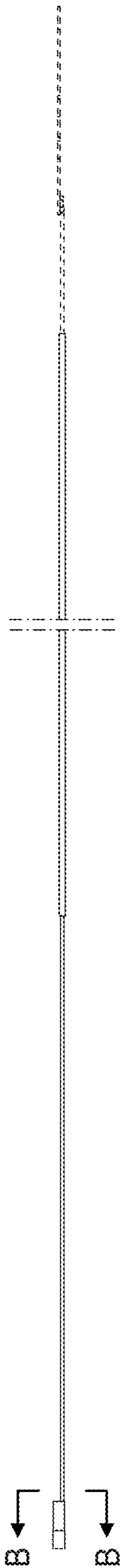
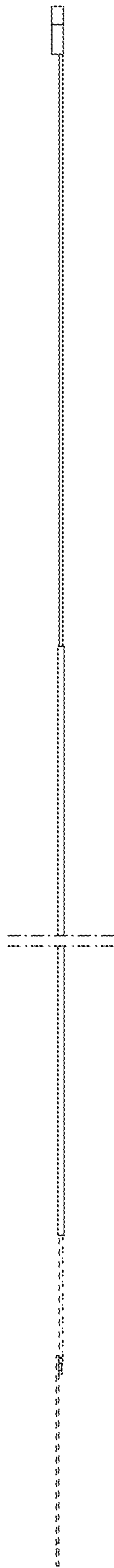

FIG. 1



**FIG. 2**



**FIG. 3**

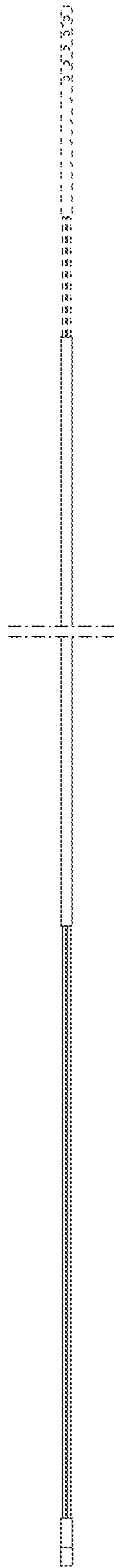

**FIG. 4**

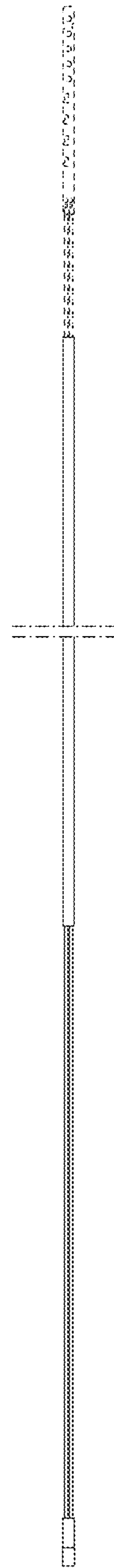

**FIG. 5**

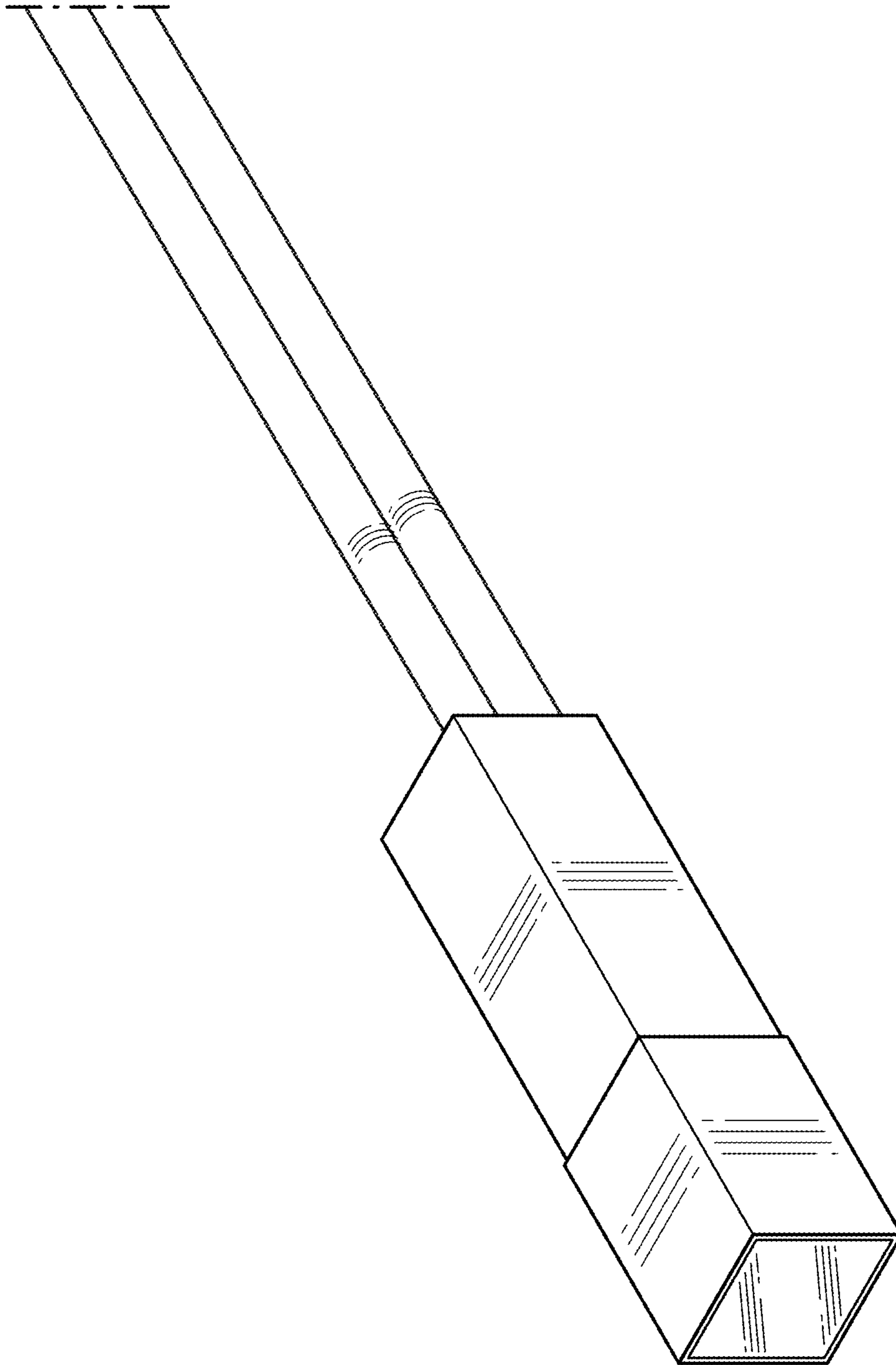

FIG. 6

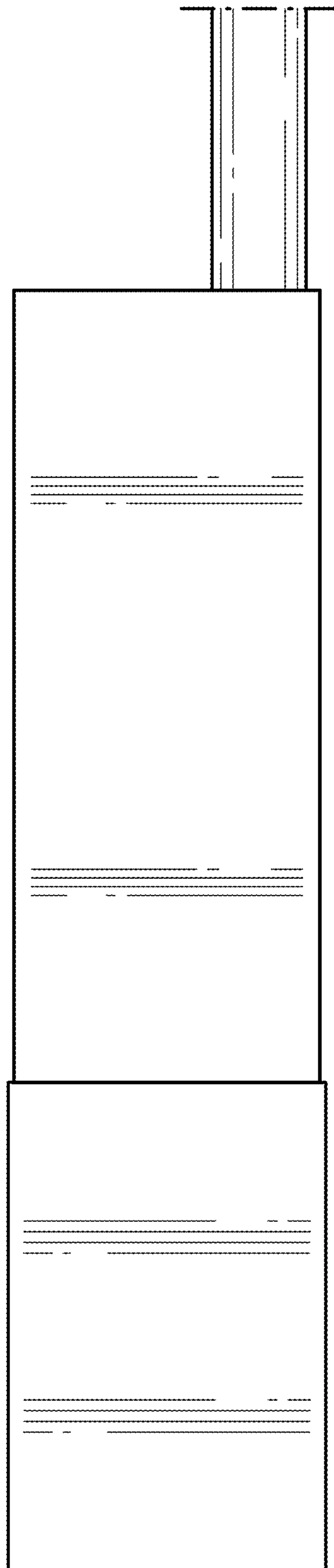
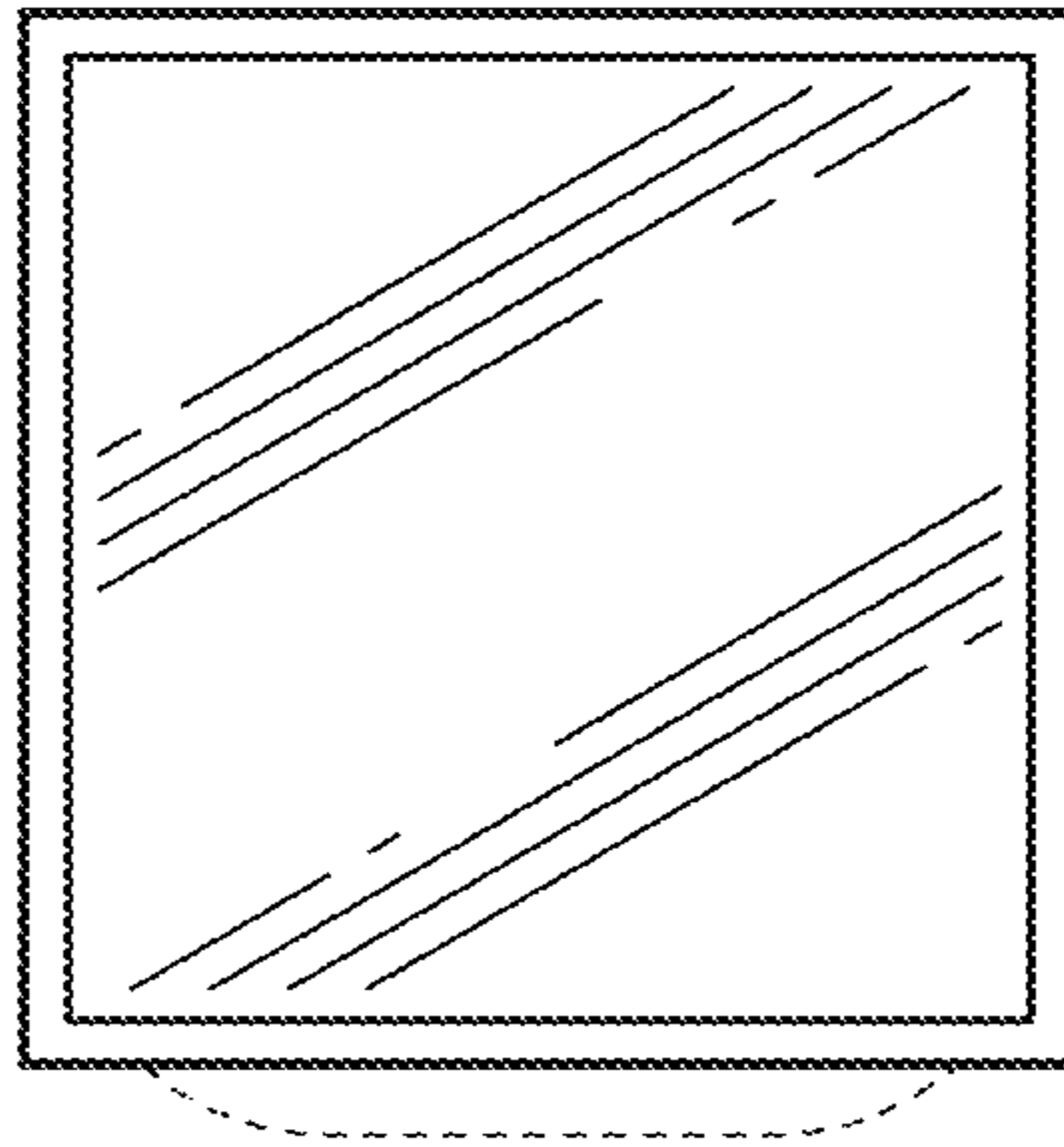
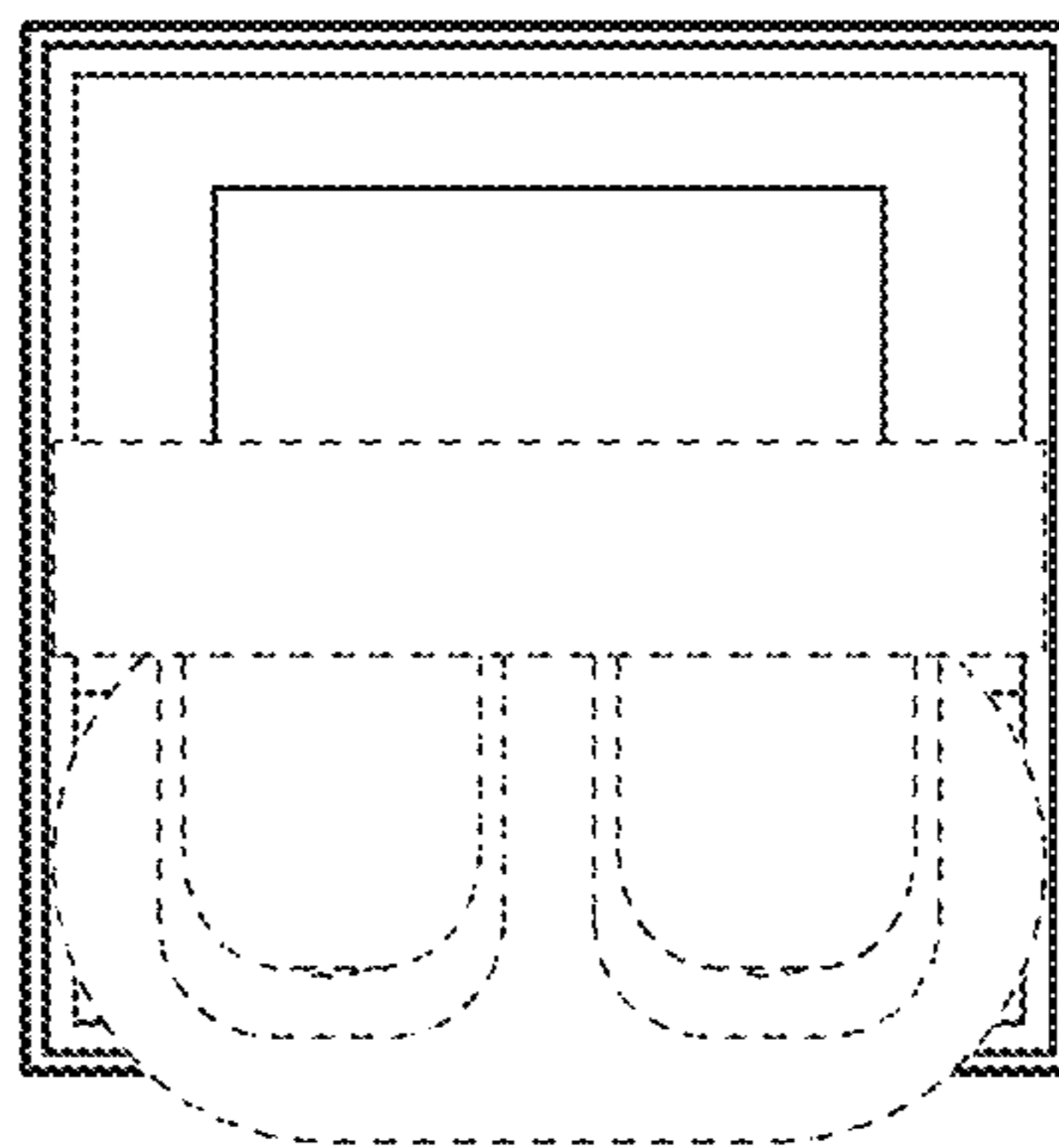

FIG. 7



**FIG. 8**



**FIG. 9**

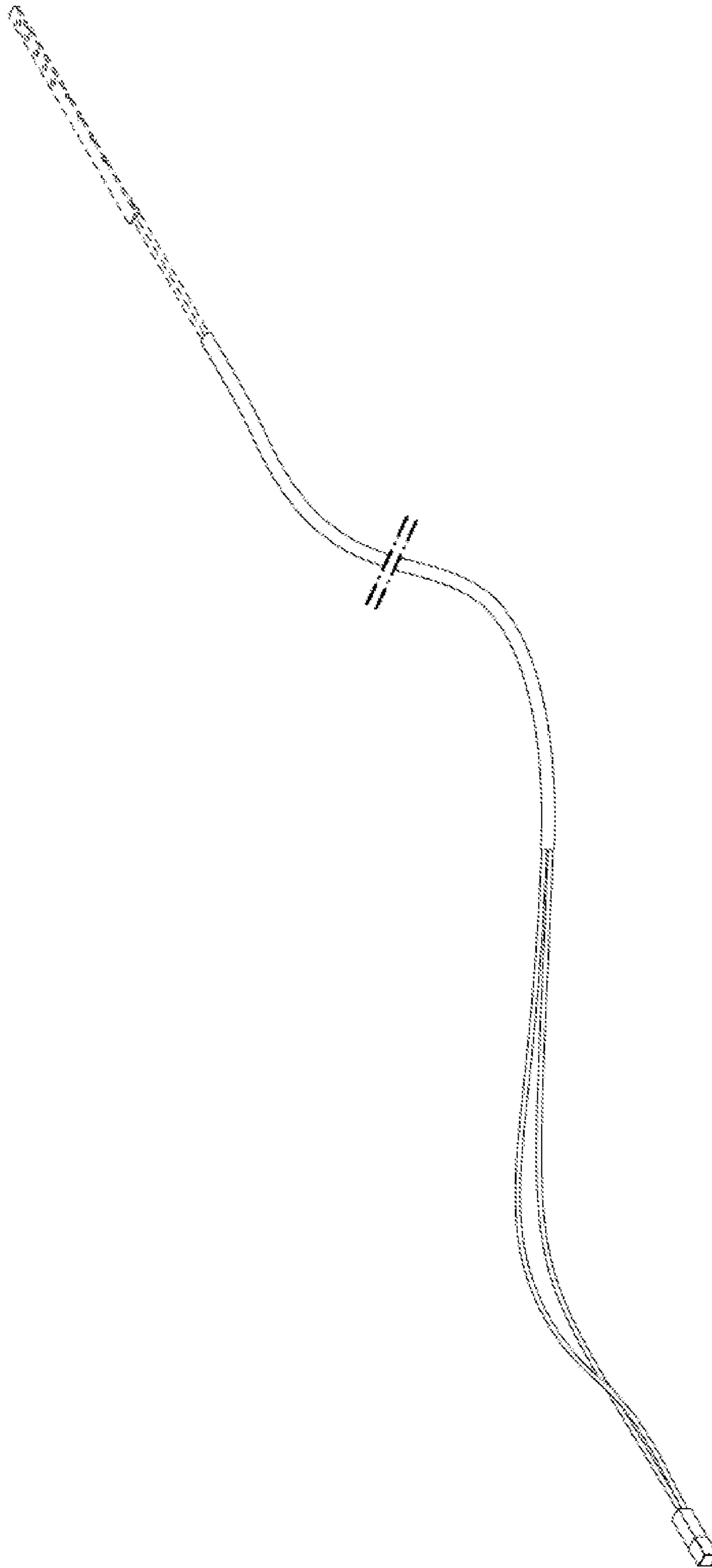

FIG. 10