



US00D878456S

(12) **United States Design Patent**
Frank et al.

(10) **Patent No.:** **US D878,456 S**
(45) **Date of Patent:** **** Mar. 17, 2020**

(54) **COIN TRAY**

(71) Applicant: **Revolution Retail Systems LLC**,
Carrollton, TX (US)
(72) Inventors: **David Scott Frank**, Coppell, TX (US);
Mark K. Levenick, Flower Mound, TX
(US)
(73) Assignee: **Revolution Retail Systems LLC**,
Carrollton, TX (US)

(**) Term: **15 Years**

(21) Appl. No.: **29/653,567**

(22) Filed: **Jun. 15, 2018**

Related U.S. Application Data

(63) Continuation of application No. 15/784,274, filed on
Oct. 16, 2017, now Pat. No. 10,262,488.

(51) **LOC (12) Cl.** **18-01**

(52) **U.S. Cl.**
USPC **D18/12.1; D18/3.1; D99/43**

(58) **Field of Classification Search**
USPC ... D18/3.3, 3.1, 3.2, 4.1, 4.4, 12, 12.1, 12.2,
D18/12.3, 46, 47, 56, 59; D14/300, 301,
D14/302, 303, 307, 308, 348, 349, 432,
D14/439, 441, 448, 449, 462, 469, 471,
D14/900, 901, 902; D10/96, 97;
D99/28, 34, 35, 43, 99, 36; D19/65, 86,
D19/100, 95, 99, 92; D20/1, 8, 9;
(Continued)

(56) **References Cited**

U.S. PATENT DOCUMENTS

D222,817 S * 1/1972 Kenmotsu D3/304
D233,345 S * 10/1974 Kneale et al. D14/308
D246,745 S * 12/1977 Charlop D99/34

(Continued)

OTHER PUBLICATIONS

EN-Quantum-1.revolutionretailsystems.com. (online image) 1 pg.
2016. [Retrieved on Jul. 8, 2019] <https://www.revolutionretailsystems.com/rrs2016/wp-content/uploads/EN-Quantum-1.jpg>.*

(Continued)

Primary Examiner — Marie D. Fast Horse
(74) *Attorney, Agent, or Firm* — Locke Lord LLP;
Charles E. Phipps; Alicia J. Carroll

(57) **CLAIM**

The ornamental design for a coin tray, as shown and
described.

DESCRIPTION

FIG. 1 is a perspective view of a currency recycler having
a coin tray;
FIG. 2 is a top elevation view of the coin tray of FIG. 1.
FIG. 3 is a bottom elevation view of the coin tray of FIG. 1;
FIG. 4 is front elevation view of the coin tray of FIG. 1;
FIG. 5 is a back elevation view of the coin tray of FIG. 1;
FIG. 6 is left-side elevation view of the coin tray; and,
FIG. 7 is right-side elevation view of the coin tray of FIG.
1.
All broken lines in FIGS. 1, 4 and 5 depict environmental
subject matter only and form no part of the claim. The
broken line in FIGS. 2-3 and 6-7 consisting of unevenly
sized dashes defines the boundary of the claim, which
extends to the boundary but does not include the boundary;
while the remaining broken lines in FIGS. 2-3 and 6-7
consisting of evenly sized dashes depict portions of the coin
tray that form no part of the claim.
The unshaded surfaces shown in FIGS. 3, 6 and 7 between
the solid lines and the broken lines form no part of the
claimed design.

1 Claim, 5 Drawing Sheets

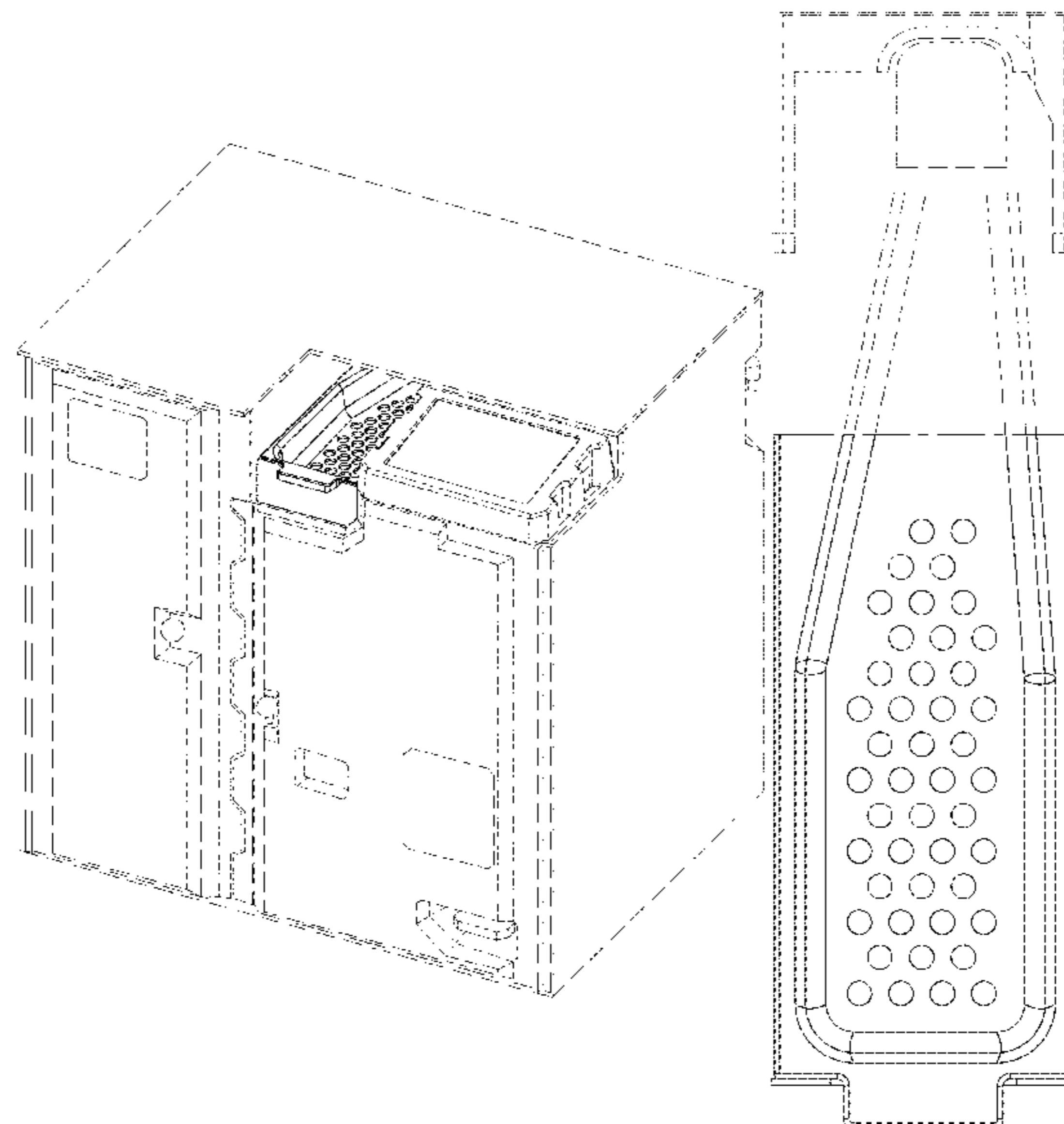

(58) **Field of Classification Search**

USPC D3/304, 307, 308, 309, 311, 312, 313,
D3/314
CPC G07G 1/00; G07G 1/0009; G07G 1/0036;
G07G 1/10; G07G 1/12; G07D 7/00;
G07D 7/04; G07D 9/008; G07D 11/00;
G07D 11/009; G07D 11/0093; G07D
11/50; G07D 2207/00; G07D 2211/00;
G07D 3/00; G07D 3/16; G07D 9/002;
G07D 9/02

See application file for complete search history.

(56) **References Cited**

U.S. PATENT DOCUMENTS

D282,966 S * 3/1986 Brown D24/229
D292,539 S * 10/1987 Harlow, Jr. D99/43
D308,274 S * 5/1990 Gosselin D3/314
4,964,495 A * 10/1990 Rasmussen G07D 3/00
194/344
D328,016 S * 7/1992 Valerio D8/10
D346,725 S * 5/1994 Kolada D7/667
D371,887 S * 7/1996 Minagawa D99/34
5,644,119 A 7/1997 Padula et al.
D389,976 S * 1/1998 Burgess D3/304
6,003,652 A 12/1999 Murata et al.
6,196,913 B1 * 3/2001 Geib G07D 3/00
235/7 A
D451,145 S * 11/2001 Taxon D99/28
6,318,536 B1 * 11/2001 Korman G06Q 20/18
194/217
D458,968 S * 6/2002 Taxon D99/28
D468,773 S * 1/2003 Bodum D19/86
D486,290 S * 2/2004 Moncman D99/34
6,863,168 B1 * 3/2005 Gerrity B07B 1/24
194/347
D515,315 S * 2/2006 Rader D3/304
D531,379 S * 10/2006 Piner D99/43
D538,538 S * 3/2007 Espinosa D3/313
D541,004 S * 4/2007 Berg D18/3.1
7,625,272 B1 12/2009 Moreland et al.
8,443,958 B2 * 5/2013 Blake G06Q 99/00
194/215
D767,239 S * 9/2016 Umeda D99/34
D810,189 S * 2/2018 Enomoto D18/3.1
D812,910 S * 3/2018 Harvey D3/304
D835,879 S * 12/2018 Schaub D99/34

D844,045 S * 3/2019 Umeda D18/3.1
D844,048 S * 3/2019 Abe D18/12.1
10,262,488 B1 * 4/2019 Frank G07D 9/008
2003/0190882 A1 * 10/2003 Blake G07D 9/008
453/63
2004/0097182 A1 5/2004 Hill et al.
2004/0256197 A1 * 12/2004 Blake G07D 3/00
194/350
2007/0087675 A1 * 4/2007 Umeda G07D 3/14
453/3
2007/0149102 A1 * 6/2007 Umeda G07D 9/00
453/56
2008/0171508 A1 * 7/2008 Enomoto G07D 1/00
453/18
2009/0120760 A1 * 5/2009 Sjostrom G07D 9/008
194/302
2009/0242626 A1 * 10/2009 Jones G06Q 40/00
235/379
2010/0230231 A1 9/2010 Uesaka et al.
2011/0263190 A1 * 10/2011 Stump G07D 3/06
453/3
2012/0156976 A1 * 6/2012 Blake G07D 3/128
453/4
2013/0199890 A1 * 8/2013 Blake G07D 9/00
194/216
2014/0030972 A1 * 1/2014 Bengtsson G07D 3/14
453/3
2014/0031974 A1 * 1/2014 Ingvarsson G07D 9/00
700/232
2016/0284151 A1 9/2016 Fujimura et al.

OTHER PUBLICATIONS

Quantum-Coin_Tray_Medium-From_Left_Top-72dpi.
revolutionretailsystems.com. (online image) 1 pg. 2016. [Retrieved
on Jul. 8, 2019] [https://www.revolutionretailsystems.com/rrs2016/
wp-content/uploads/Quantum-Coin_Tray_Medium-From_Left_Top-
72dpi.jpg](https://www.revolutionretailsystems.com/rrs2016/wp-content/uploads/Quantum-Coin_Tray_Medium-From_Left_Top-72dpi.jpg). *
Quantum-top-draw-out-72dpi-500x333.jpg. revolutionretailsystems.
com. (online image) 1 pg. 2016. [Retrieved on Jul. 8, 2019]
[https://www.revolutionretailsystems.com/rrs2016/wp-content/
uploads/Quantum-top-draw-out-72dpi-500x333.jpg](https://www.revolutionretailsystems.com/rrs2016/wp-content/uploads/Quantum-top-draw-out-72dpi-500x333.jpg). *
Revolution Retail Systems: Quantum™ Series. (online) 2 pgs.
Images individually dated 2016 [Retrieved on Jul. 9, 2019] [https://
www.revolutionretailsystems.com/quantum-series/](https://www.revolutionretailsystems.com/quantum-series/). *

* cited by examiner

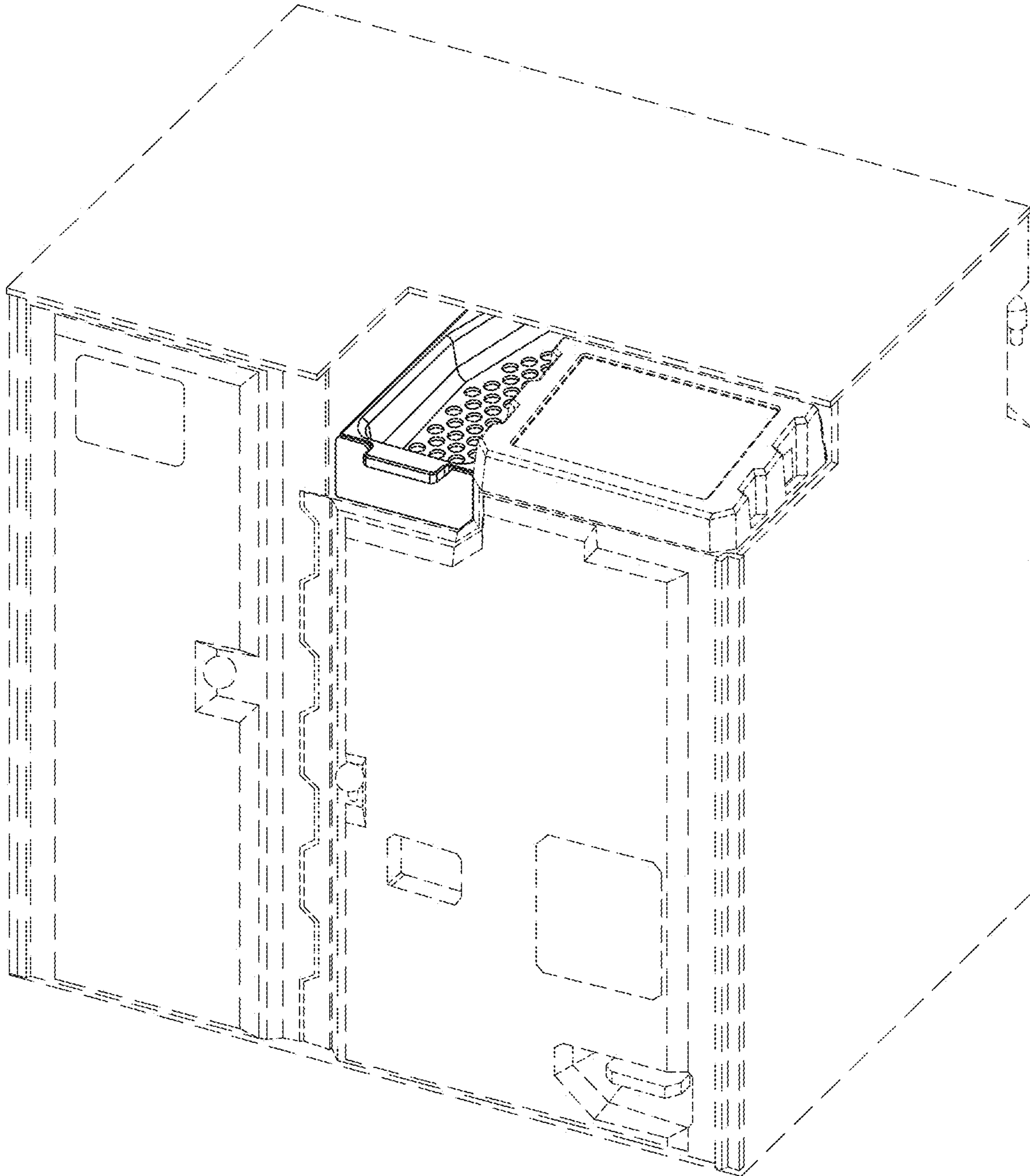

FIG. 1

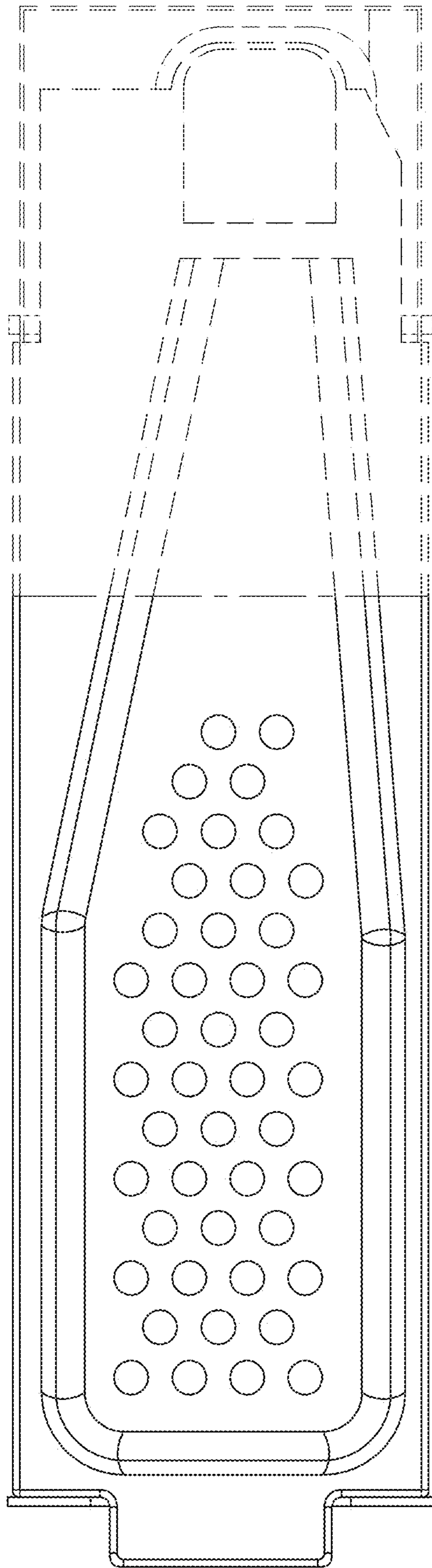

FIG. 2

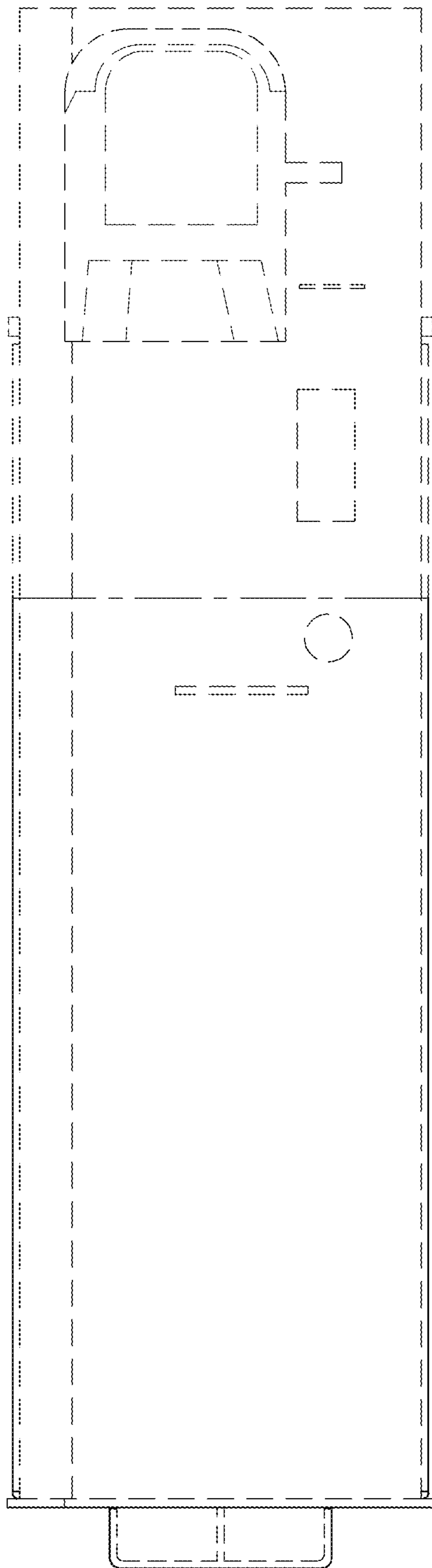

FIG. 3

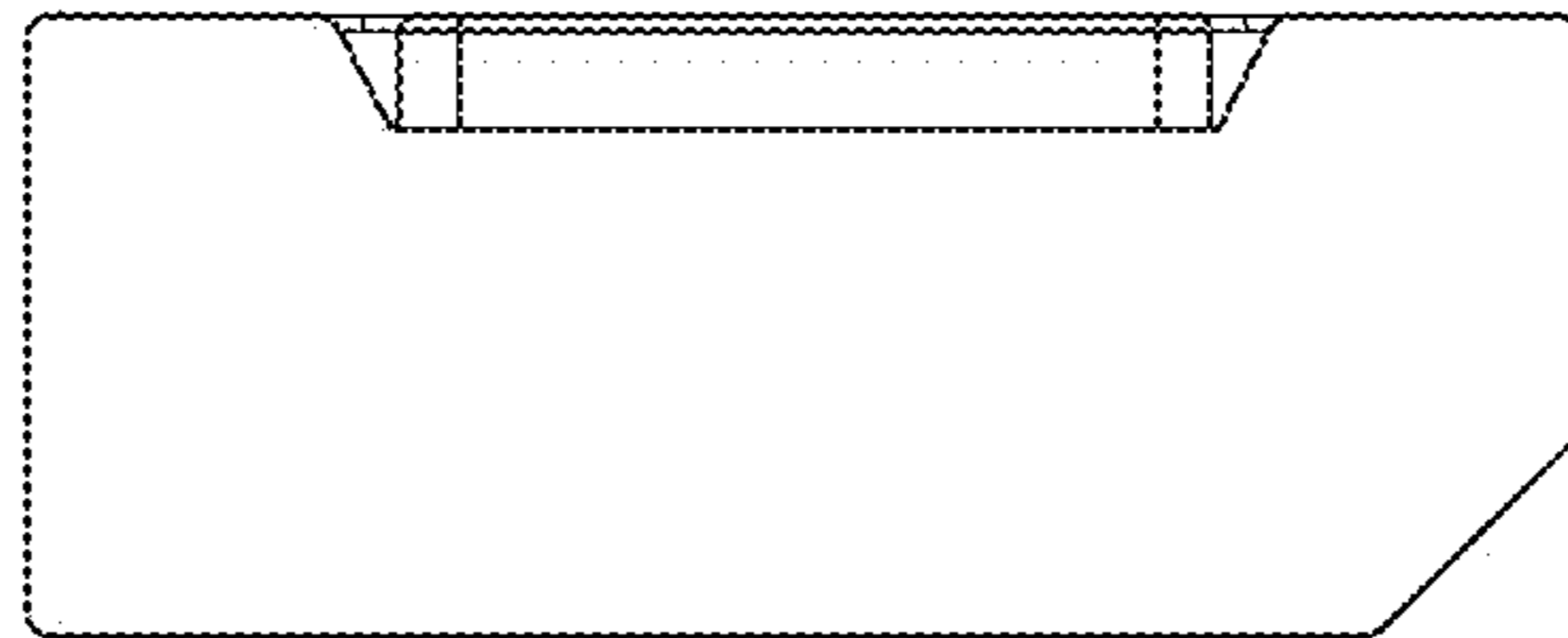

FIG. 4



FIG. 5

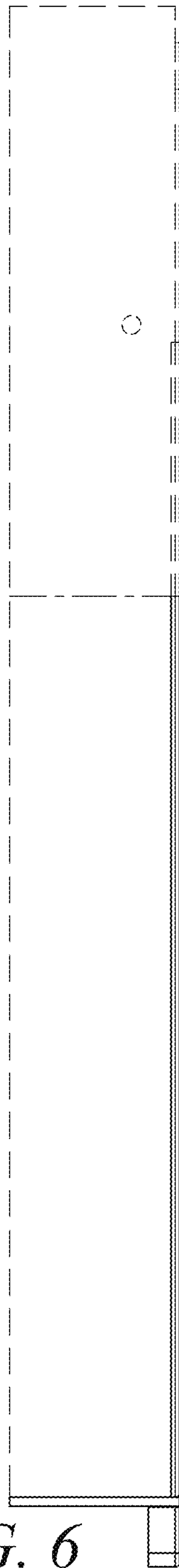

FIG. 6

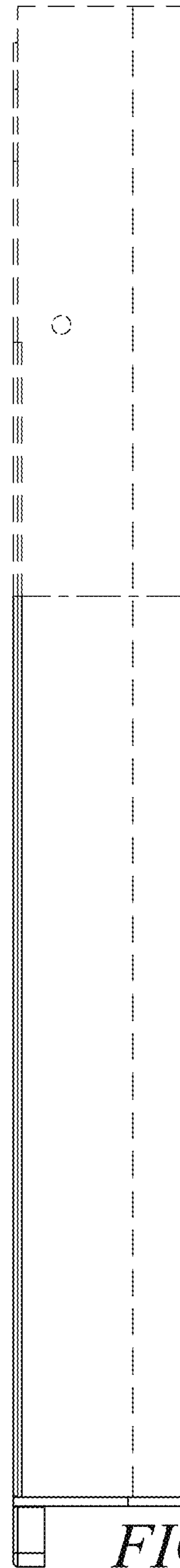

FIG. 7