



US00D878363S

(12) **United States Design Patent**  
**Zhai et al.**

(10) **Patent No.:** **US D878,363 S**  
(45) **Date of Patent:** **\*\* Mar. 17, 2020**

(54) **TABLET COMPUTER**

(71) Applicant: **HUAWEI TECHNOLOGIES CO., LTD.**, Shenzhen (CN)

(72) Inventors: **Xiaodong Zhai**, Shenzhen (CN); **Gerd Kleiner**, Shenzhen (CN)

(73) Assignee: **HUAWEI TECHNOLOGIES CO., LTD.**, Shenzhen (CN)

(\*\*) Term: **15 Years**

(21) Appl. No.: **29/574,606**

(22) Filed: **Aug. 17, 2016**

(30) **Foreign Application Priority Data**

Feb. 18, 2016 (CN) ..... 2016 3 0046979

(51) **LOC (12) Cl.** ..... **14-02**

(52) **U.S. Cl.**  
USPC ..... **D14/341**

(58) **Field of Classification Search**

USPC .... D14/125, 126, 127-137, 138 R, 138 AA, D14/138 G, 239, 314-316, 322, 326, D14/334-336, 339, 340, 341-345, 371, D14/373-374, 420, 426, 448, 450, 248, D14/496, 203.7, 388-389; D6/300, 310, D6/314, 320, 332, 553; D21/329, 332, D21/515, 324; D10/104.1, 65  
CPC ..... G06F 1/16; G06F 1/1601; G06F 1/1637; G06F 3/044; G06F 3/0488; G06F 3/4886; G06F 3/0412; G06F 3/0416; G06F 1/1613; G06F 1/1626; G06F 2200/1633; H04N 5/64; H05K 5/0204; H05K 5/0017; H05K 5/0217; H04B 1/3833  
See application file for complete search history.

(56) **References Cited**

**U.S. PATENT DOCUMENTS**

D504,889 S \* 5/2005 Andre ..... D14/341  
D677,181 S \* 3/2013 Lenz ..... D10/65

D680,524 S \* 4/2013 Feng ..... D14/341  
D684,553 S \* 6/2013 Kim ..... D14/138 G  
D695,250 S \* 12/2013 Kim ..... D14/138 G  
D696,250 S \* 12/2013 Wang ..... D14/341

(Continued)

**OTHER PUBLICATIONS**

Huawei MediaPad M2 10.0 pictures. Annouced Feb. 2016 [online], [retrieved Aug. 30, 2018]. Available from Internet, URL: <https://www.gsmarena.com/huawei\_mediapad\_m2\_10\_0-pictures-7854.php> (Year: 2016).\*

*Primary Examiner* — T Chase Nelson

*Assistant Examiner* — Dana K Weiland

(74) *Attorney, Agent, or Firm* — Kilpatrick Townsend & Stockton LLP

(57) **CLAIM**

The ornamental design for a tablet computer, as shown and described.

**DESCRIPTION**

FIG. 1 is a front perspective view of a tablet computer showing our new design;  
FIG. 2 is a rear perspective view thereof;  
FIG. 3 is a front view thereof;  
FIG. 4 is an enlarged view of the portion of the tablet computer shown within the area designated as 4 in FIG. 3;  
FIG. 5 is a rear view of the tablet computer;  
FIG. 6 is a left side view thereof;  
FIG. 7 is an enlarged view of the portion of the tablet computer shown within the area designated as 7 in FIG. 6;  
FIG. 8 is a right side view of the tablet computer;  
FIG. 9 is a top view thereof; and,  
FIG. 10 is a bottom view thereof.  
The broken line showing of portions of the tablet computer in FIGS. 1-6 and 8 is for the purpose of illustrating environmental structure and forms no part of the claimed design.

**1 Claim, 10 Drawing Sheets**

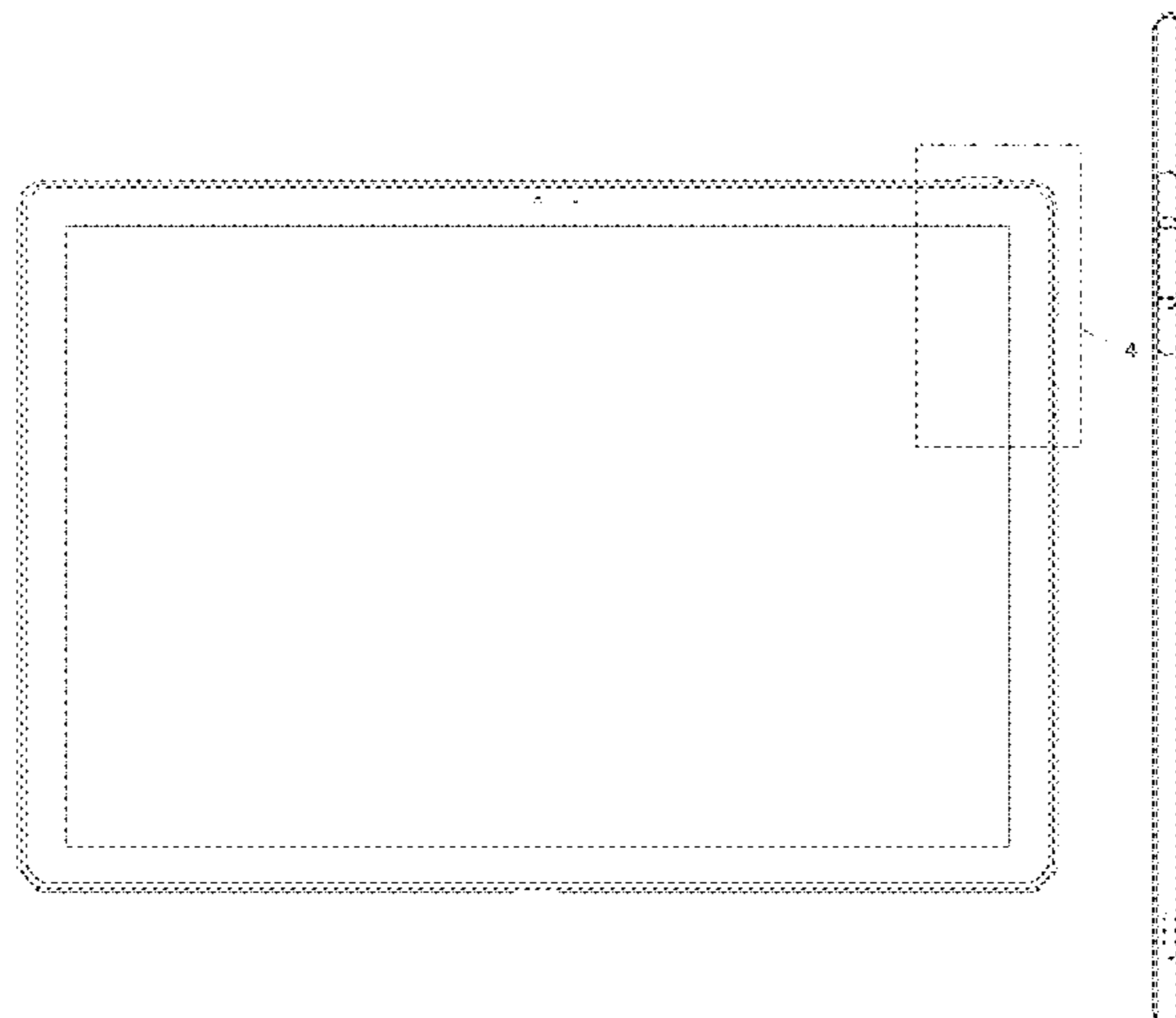

(56)

References Cited

U.S. PATENT DOCUMENTS

D701,202 S \* 3/2014 Choi ..... D14/138 G  
 D702,228 S \* 4/2014 Park ..... D14/341  
 D706,775 S \* 6/2014 Akana ..... D14/341  
 D712,400 S \* 9/2014 Kim ..... D14/341  
 D714,782 S \* 10/2014 Ohshima ..... D14/341  
 D720,746 S \* 1/2015 Chung ..... D14/341  
 D727,315 S \* 4/2015 Jensen ..... D14/341  
 D736,203 S \* 8/2015 Kim ..... D14/341  
 D738,879 S \* 9/2015 Hwangbo ..... D14/374  
 D738,880 S \* 9/2015 Hwangbo ..... D14/374  
 D738,881 S \* 9/2015 Hwangbo ..... D14/374  
 D743,961 S \* 11/2015 Oh ..... D14/341  
 D745,510 S \* 12/2015 Lee ..... D14/341  
 D746,283 S \* 12/2015 Cha ..... D14/341  
 D746,284 S \* 12/2015 Lee ..... D14/341  
 D750,077 S \* 2/2016 Lee ..... D14/375  
 D750,620 S \* 3/2016 Zhai ..... D14/203.7

D757,715 S \* 5/2016 Choi ..... D14/341  
 D758,361 S \* 6/2016 Yeo ..... D14/341  
 D763,846 S \* 8/2016 Lee ..... D14/341  
 D763,847 S \* 8/2016 Lee ..... D14/341  
 D764,455 S \* 8/2016 Akana ..... D14/341  
 D771,620 S \* 11/2016 Kim ..... D14/341  
 D771,622 S \* 11/2016 Akana ..... D14/341  
 D774,031 S \* 12/2016 Otani ..... D14/341  
 D780,175 S \* 2/2017 Jung ..... D14/341  
 D807,348 S \* 1/2018 Wang ..... D14/341  
 D808,957 S \* 1/2018 Tian ..... D14/341  
 D819,019 S \* 5/2018 Zhang ..... D14/341  
 D820,253 S \* 6/2018 Kim ..... D14/341  
 D822,015 S \* 7/2018 Biddle ..... D14/341  
 D835,097 S \* 12/2018 Morgan ..... D14/341  
 D836,580 S \* 12/2018 Ostensen ..... D14/126  
 D858,513 S \* 9/2019 Huh ..... D14/341  
 D859,397 S \* 9/2019 Akana ..... D14/341  
 2012/0229973 A1 \* 9/2012 Ting ..... G06F 1/1626  
 361/679.56

\* cited by examiner

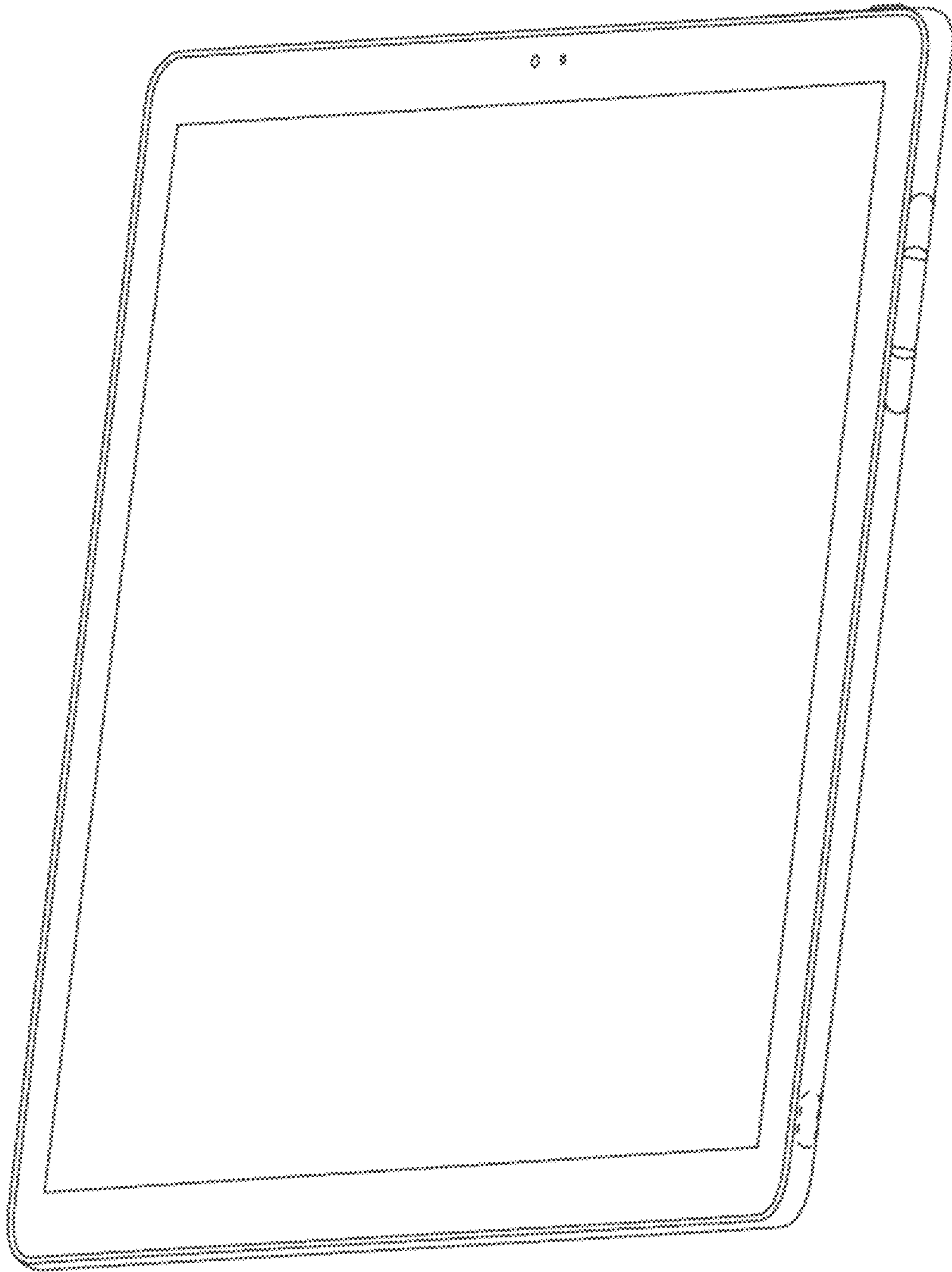

FIG. 1

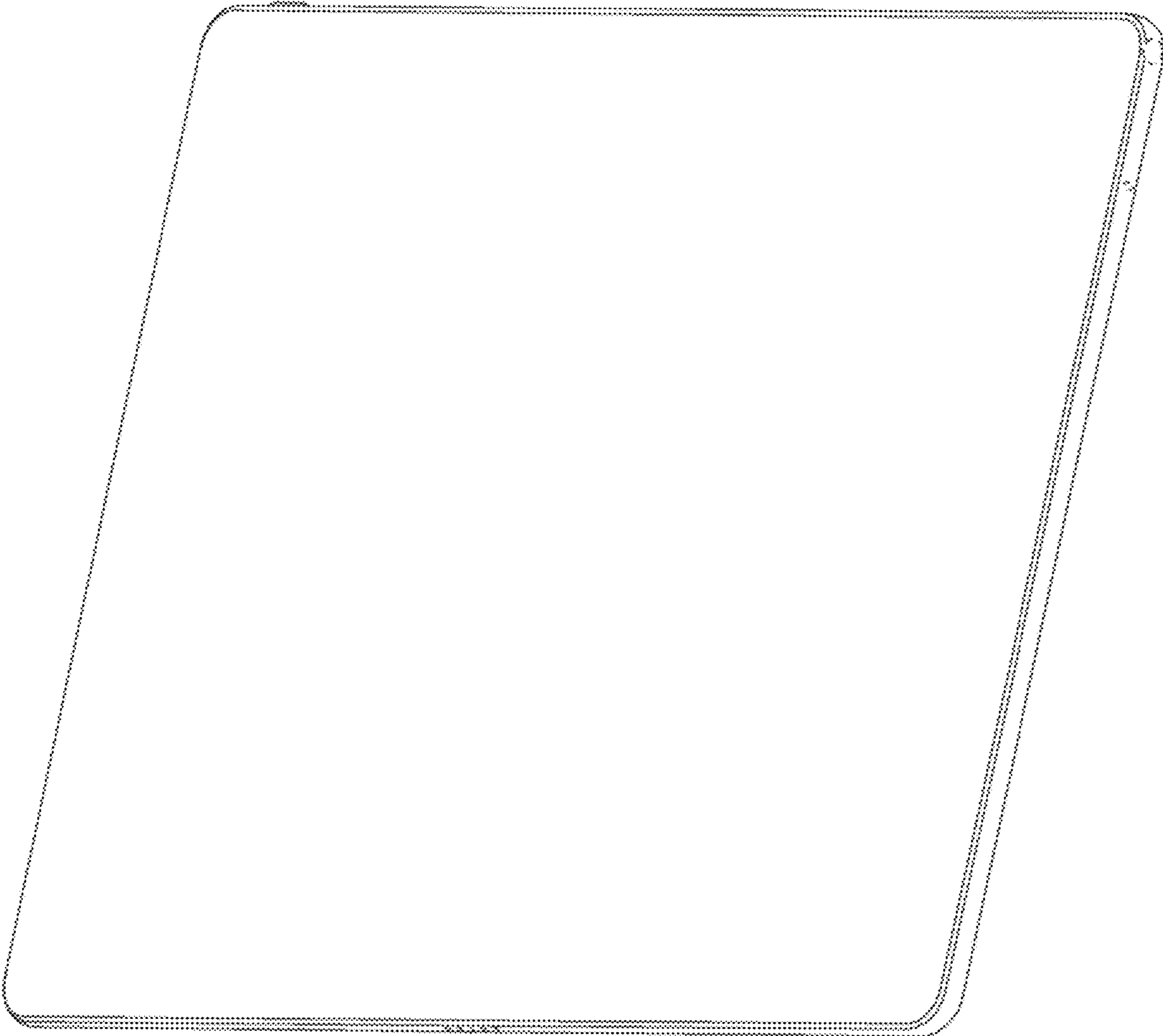

FIG. 2



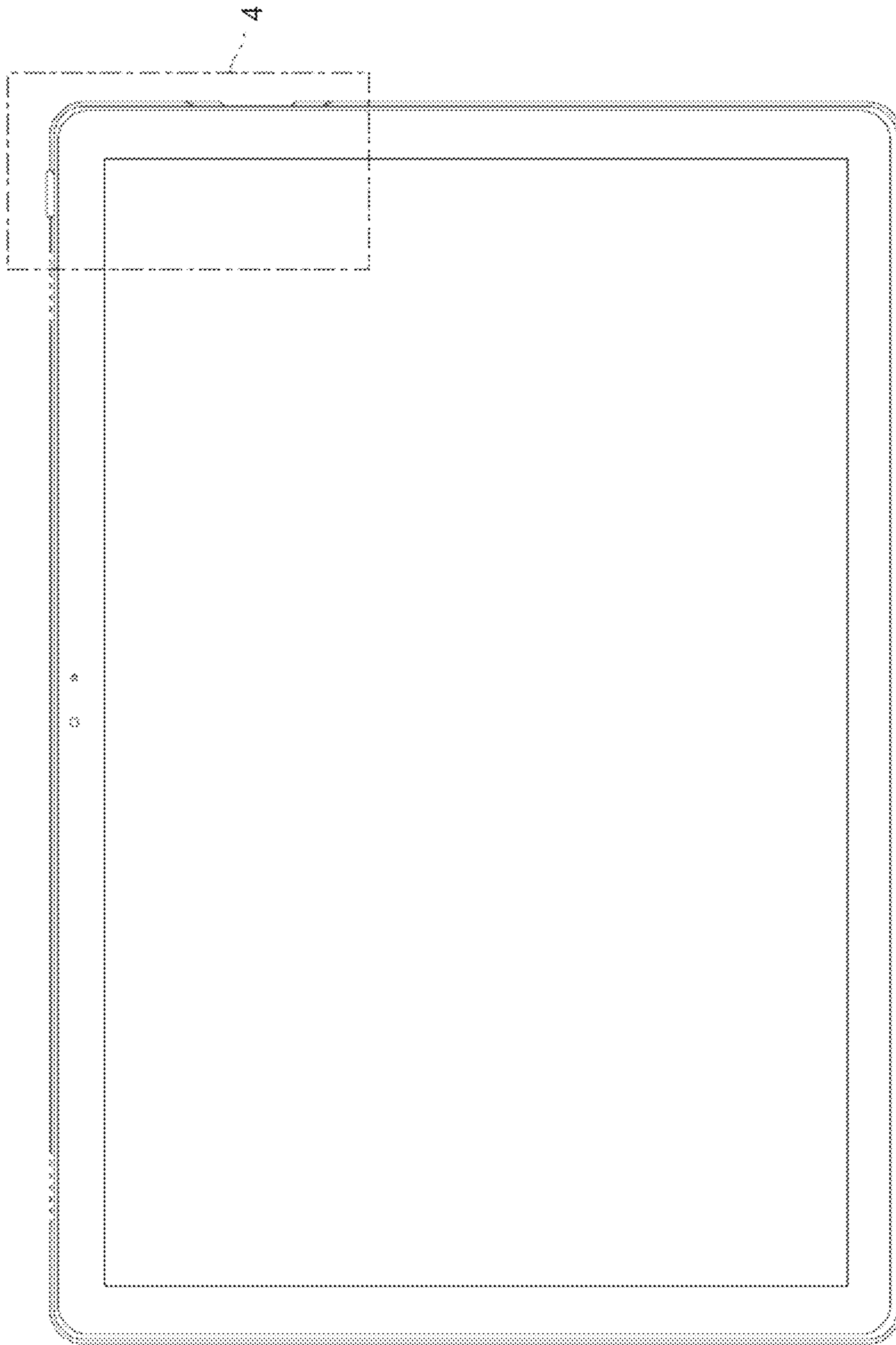

FIG. 3

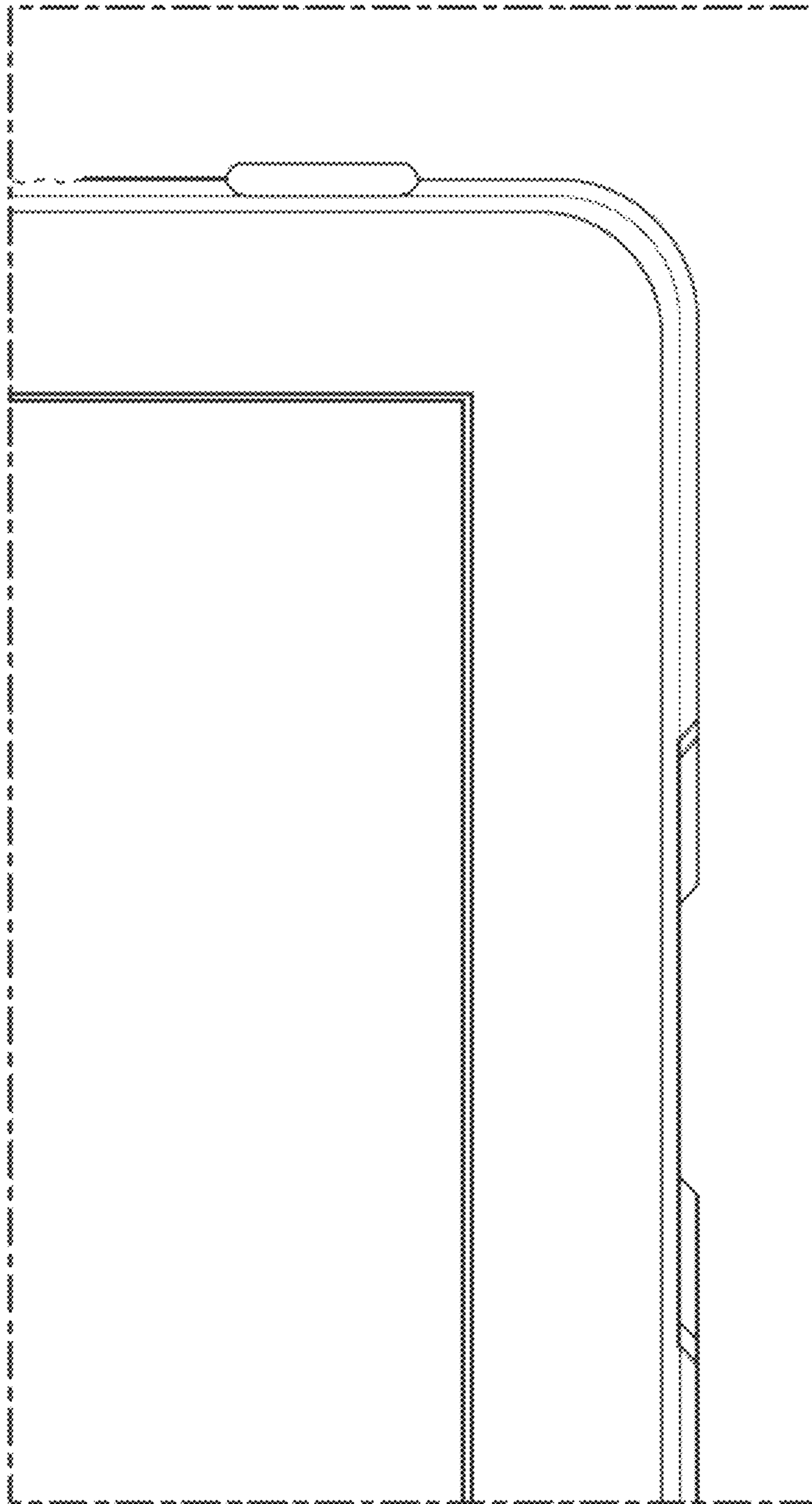

FIG. 4

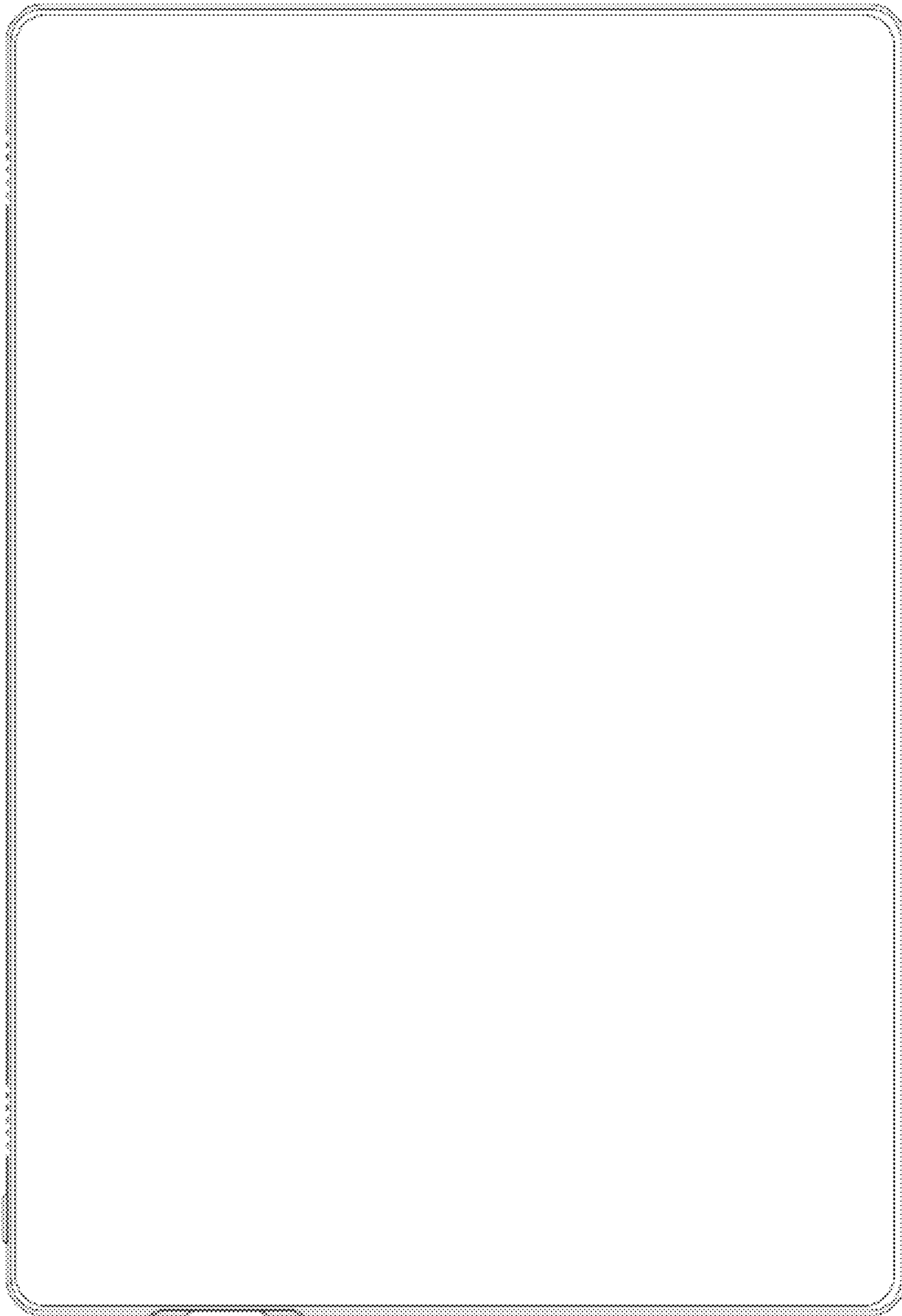

FIG. 5

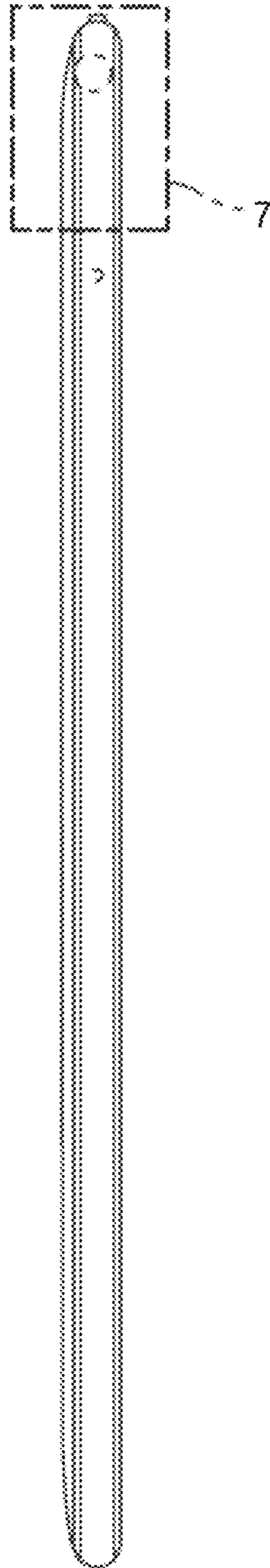

FIG. 6



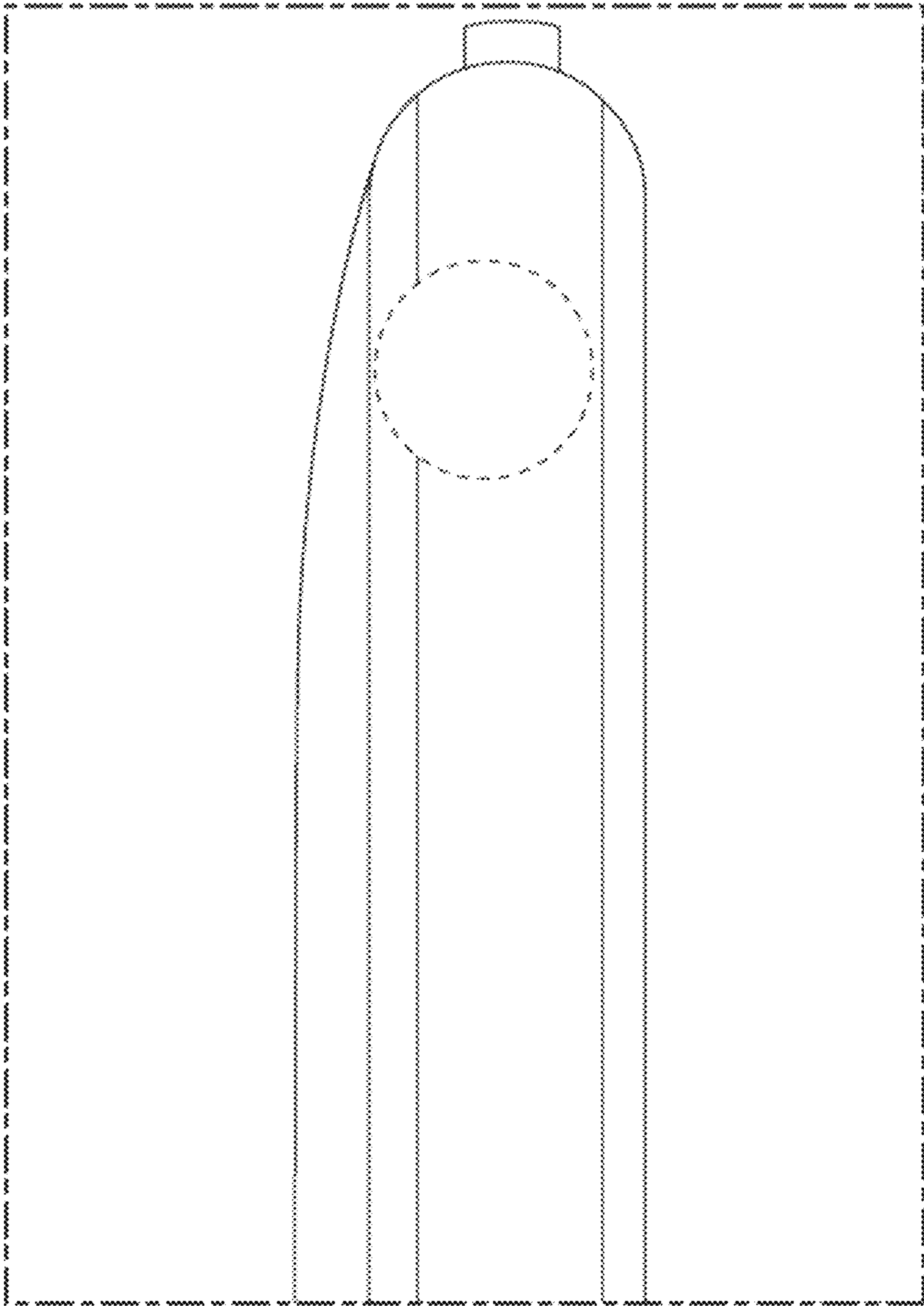

FIG. 7

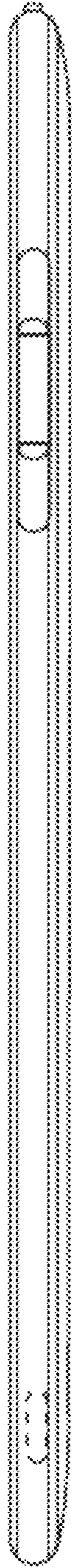

FIG. 8



FIG. 9



FIG. 10