



US00D878354S

(12) **United States Design Patent**
Quilling, II

(10) **Patent No.:** **US D878,354 S**

(45) **Date of Patent:** **** Mar. 17, 2020**

(54) **AUTO STEREO MOUNTING DEVICE**

(56) **References Cited**

(71) Applicant: **Metra Electronics Corporation**, Holly Hill, FL (US)

U.S. PATENT DOCUMENTS

(72) Inventor: **R. Spencer Quilling, II**, DeLand, FL (US)

D582,912 S * 12/2008 Quilling, II D14/258
D611,939 S * 3/2010 Quilling, II D14/258
D639,292 S * 6/2011 Fiore, IV D14/258
D755,776 S * 5/2016 Fiore, IV D14/258

(73) Assignee: **Metra Electronics Corporation**, Holly Hill, FL (US)

* cited by examiner

(**) Term: **15 Years**

Primary Examiner — Sandra L Morris

(21) Appl. No.: **29/679,822**

(74) *Attorney, Agent, or Firm* — J. Wiley Horton

(22) Filed: **Feb. 11, 2019**

(57) **CLAIM**

(51) **LOC (12) Cl.** **14-03**

The ornamental design for an auto stereo mounting device, as shown and described.

(52) **U.S. Cl.**

DESCRIPTION

USPC **D14/258**

(58) **Field of Classification Search**

USPC D12/192, 195, 415, 420; D14/496, D14/498-506, 154, 157, 168-171, D14/188-198, 257-258; 248/27.1, 27.3, 248/558; 455/347, 350

CPC B60R 11/02; B60K 37/04; B60K 37/06

See application file for complete search history.

1 Claim, 6 Drawing Sheets

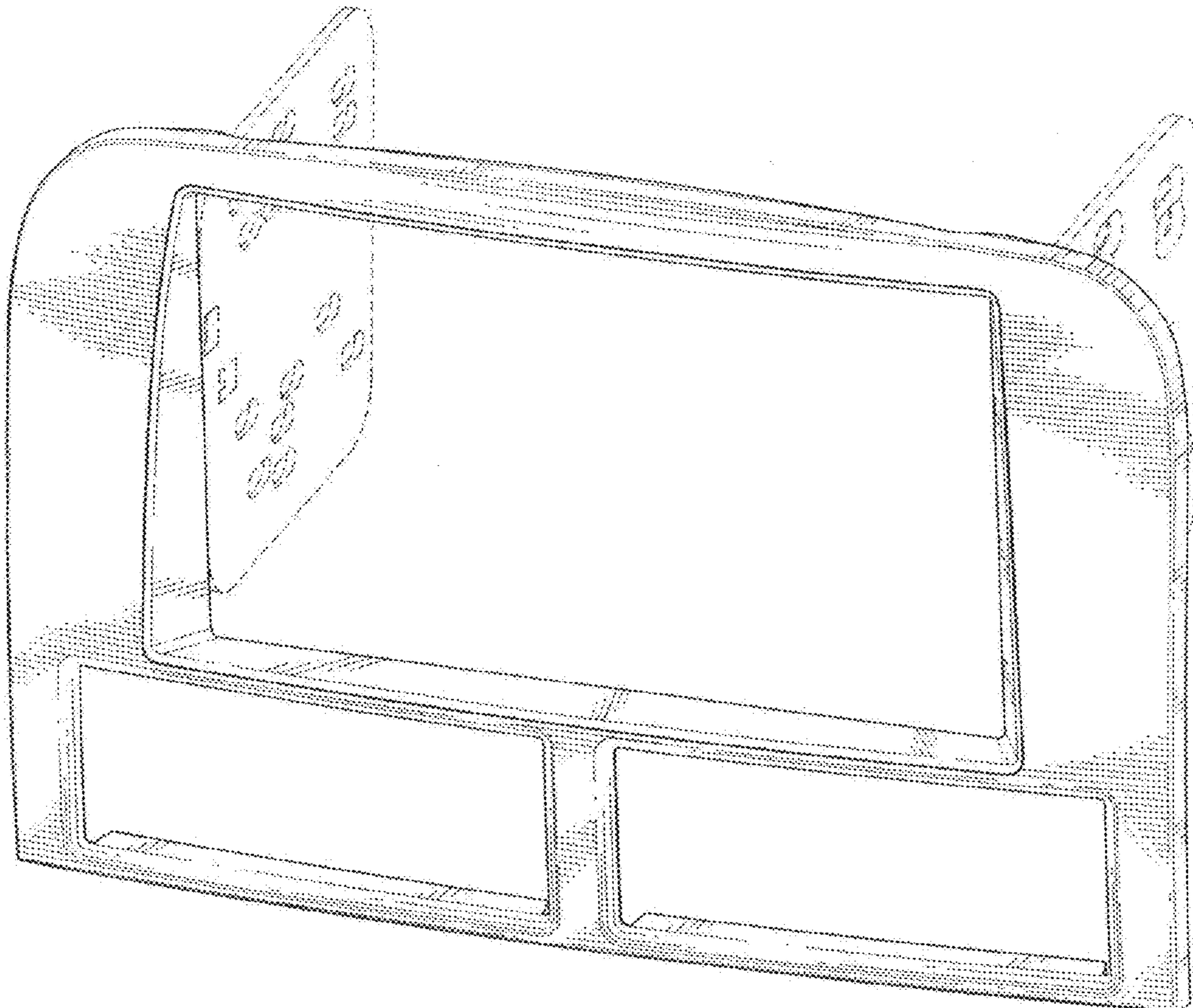

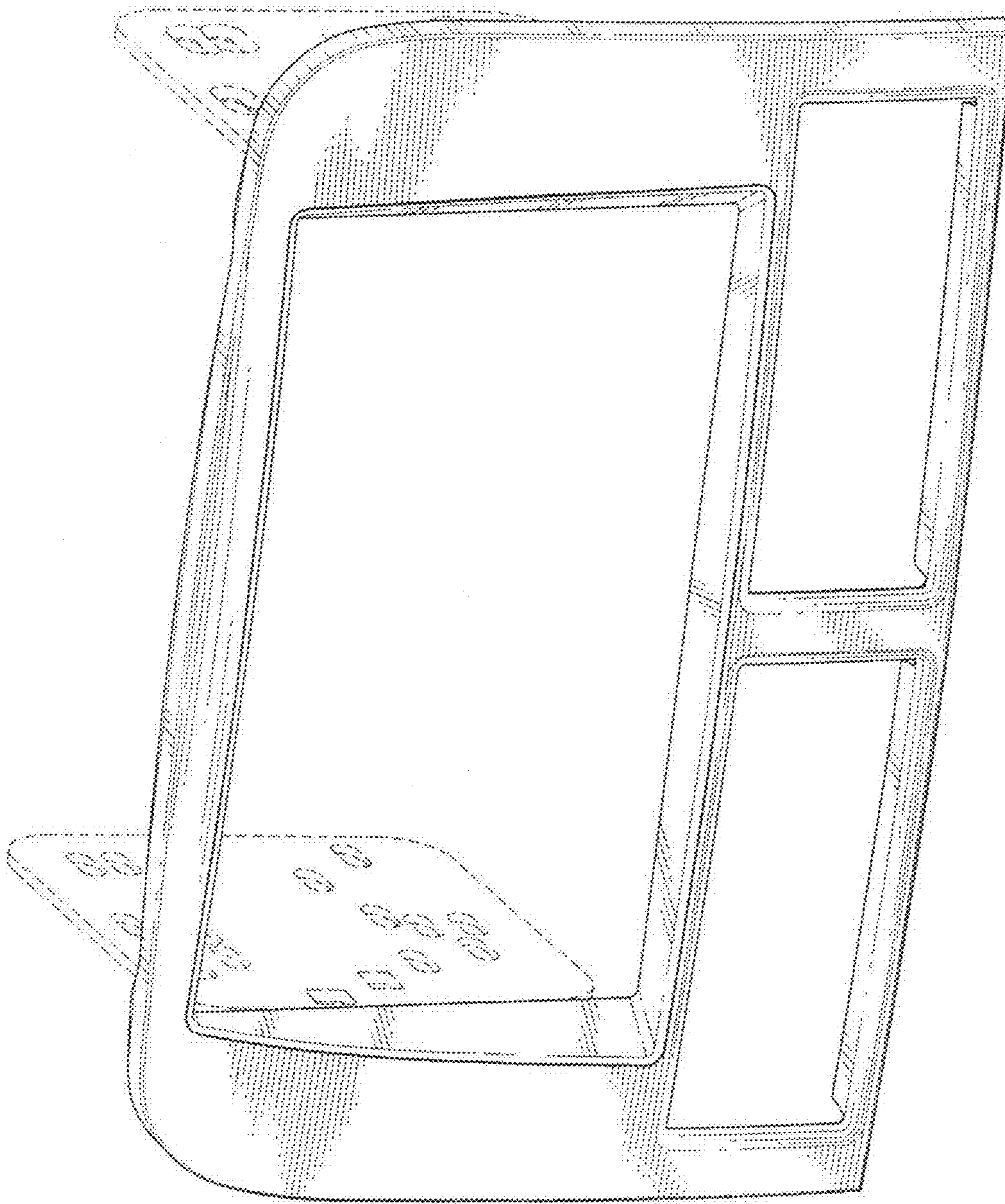

FIG. 1

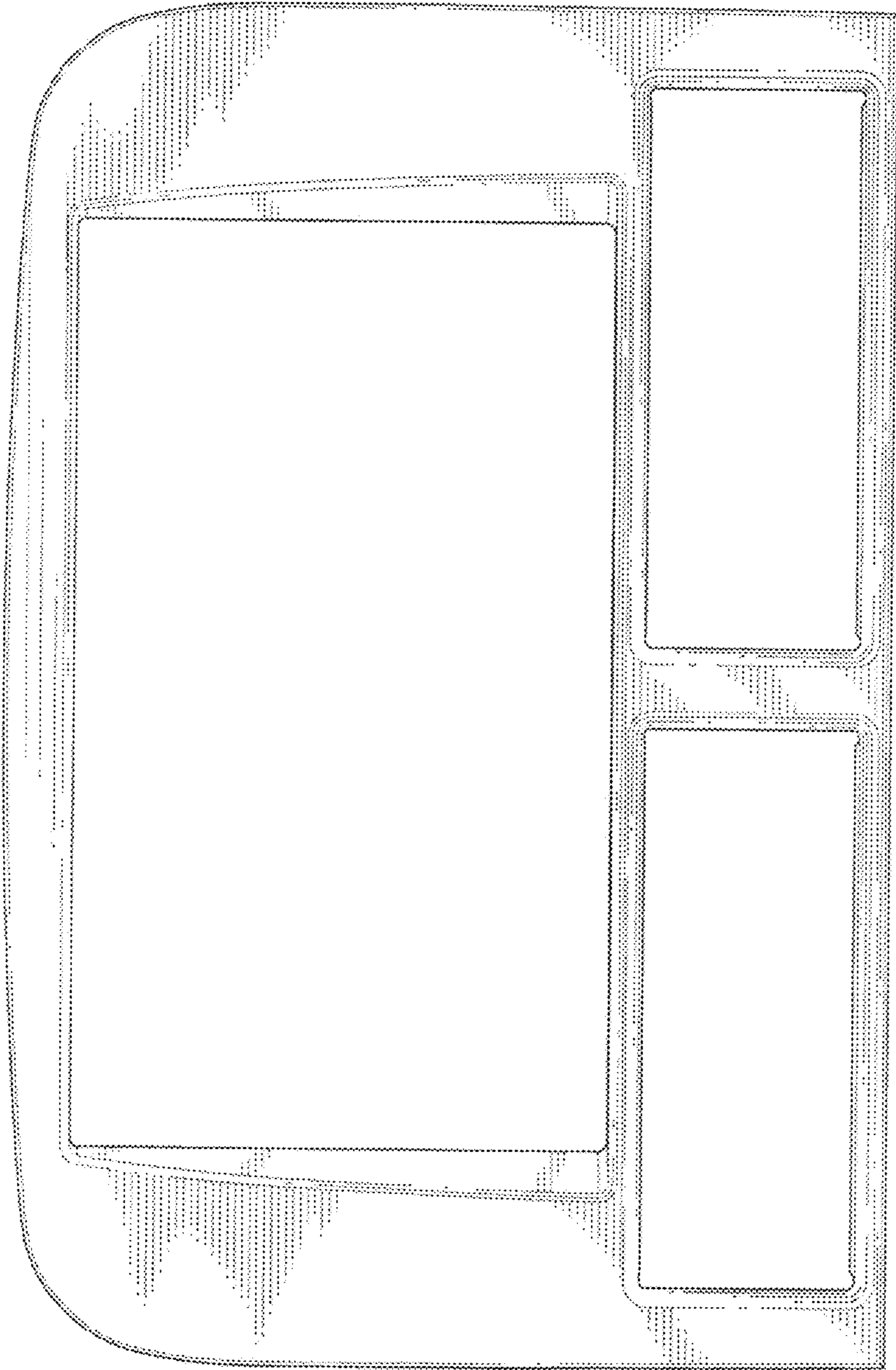

FIG. 2

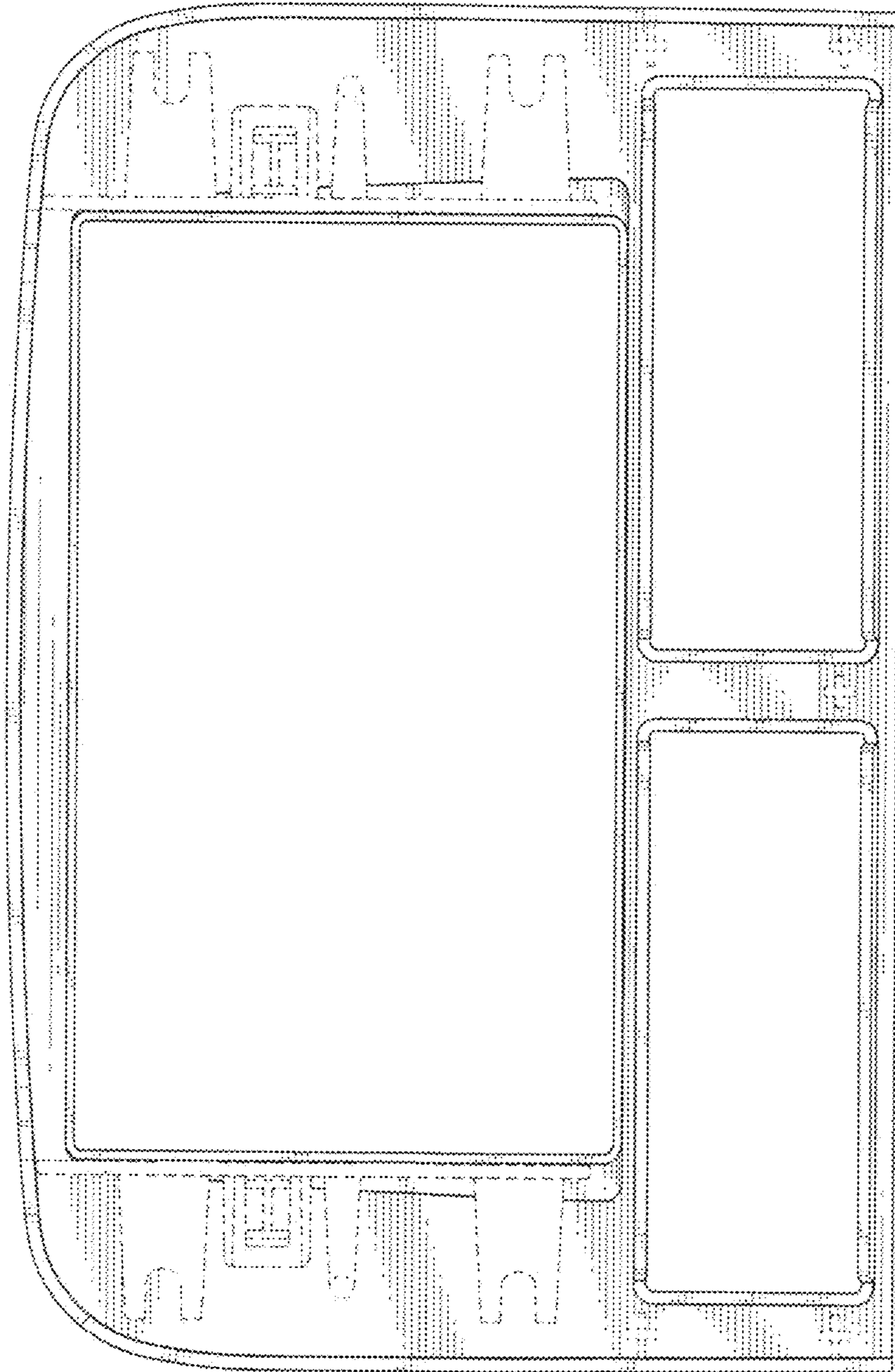

FIG. 3

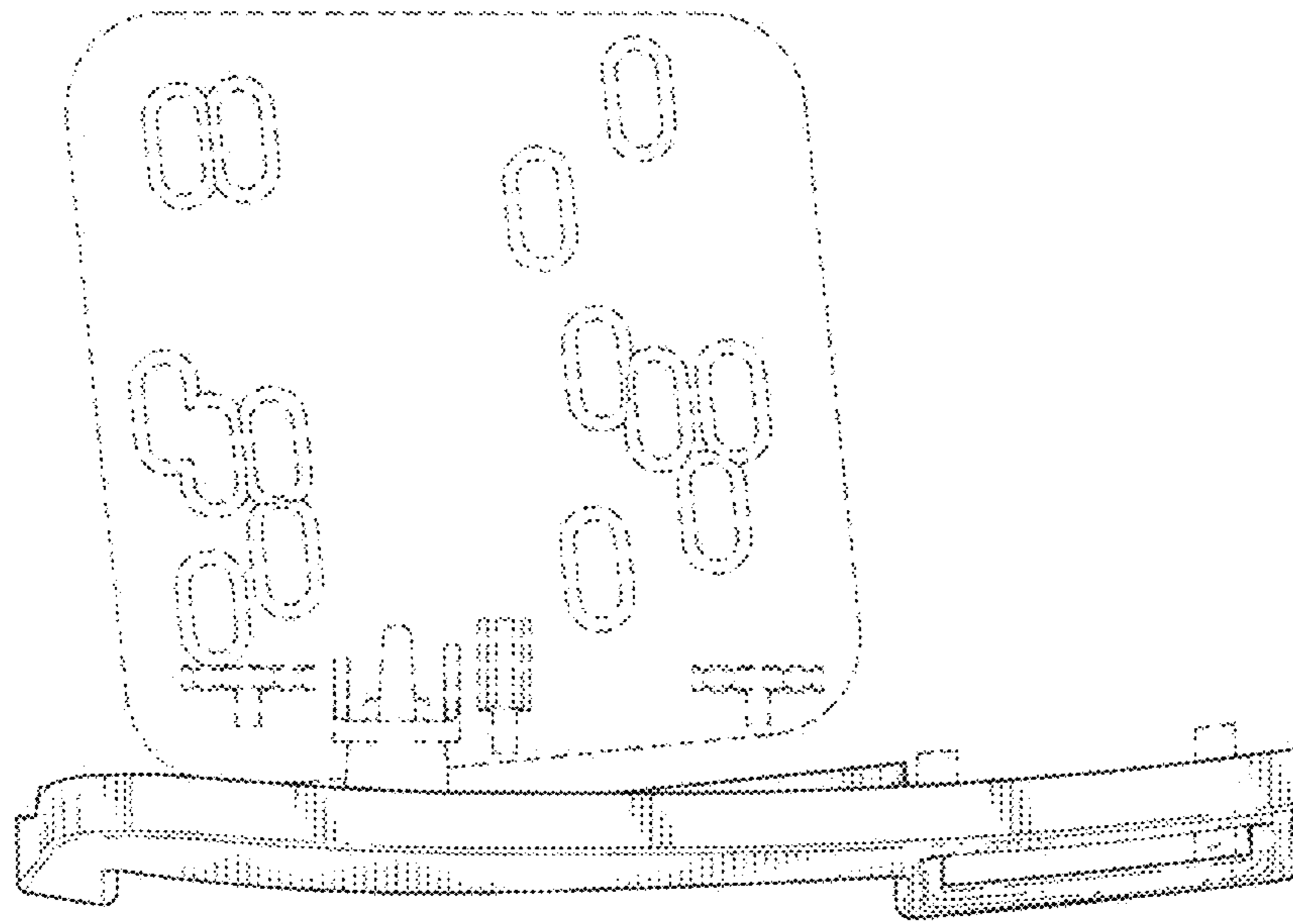

FIG. 5

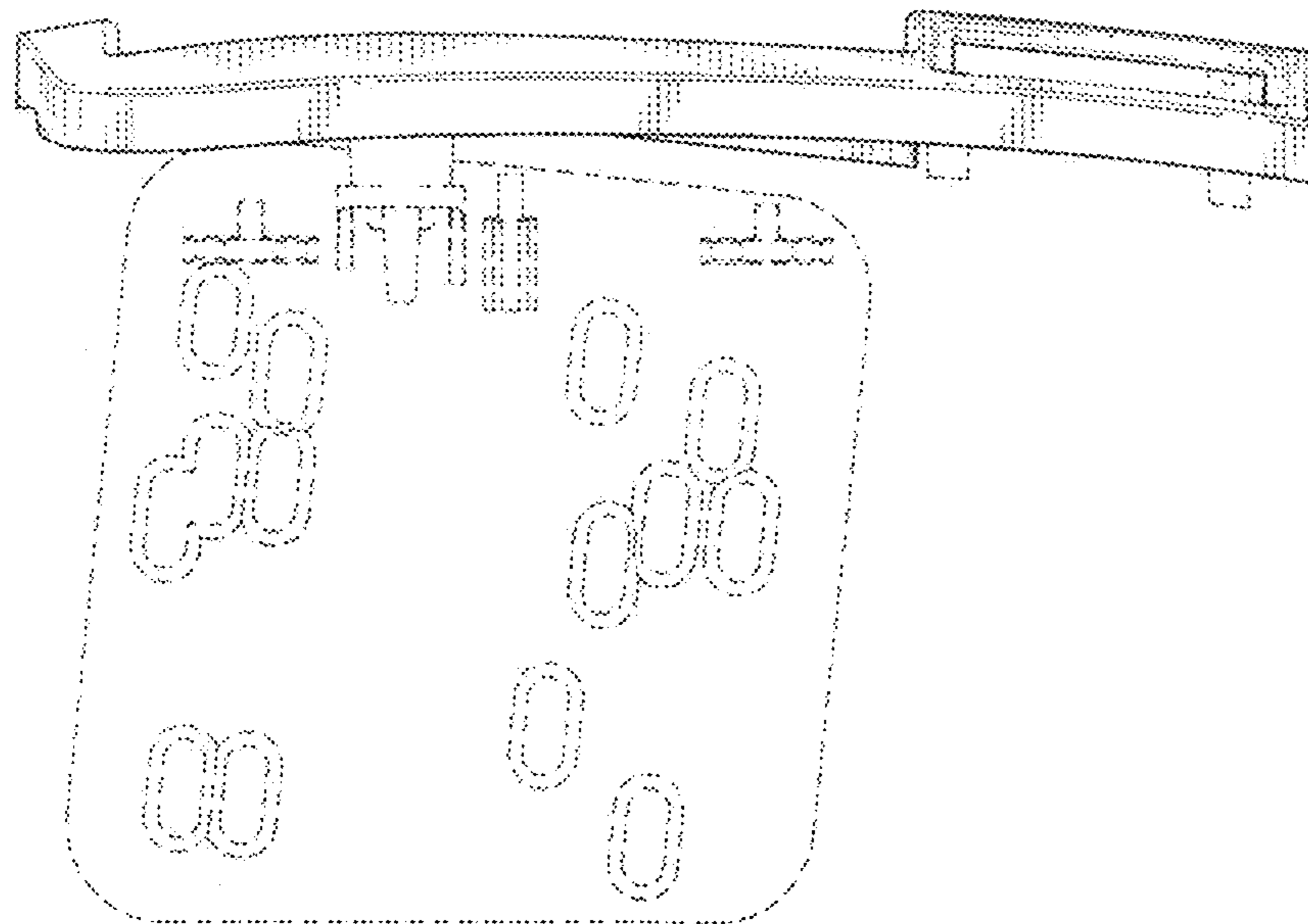

FIG. 4

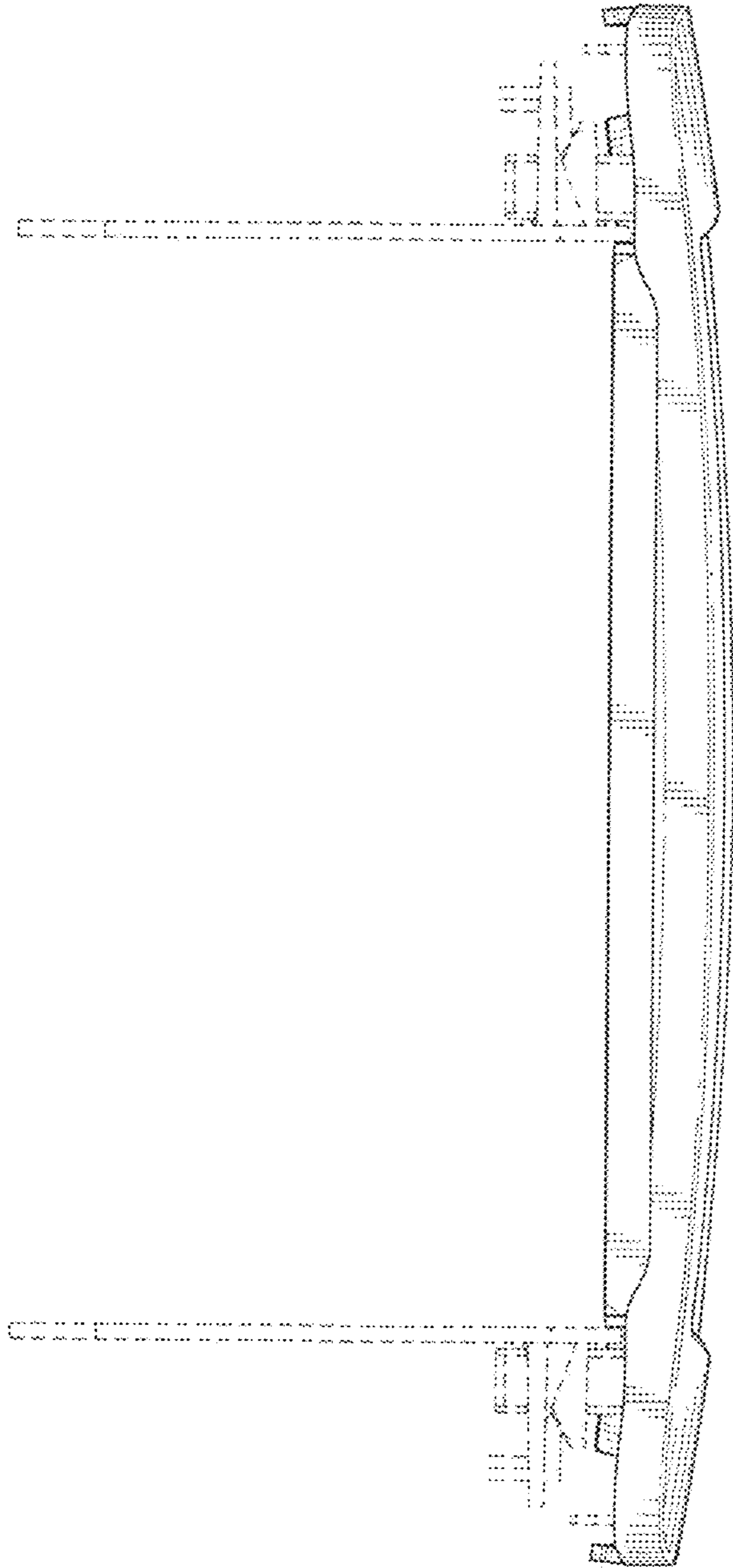

FIG. 6

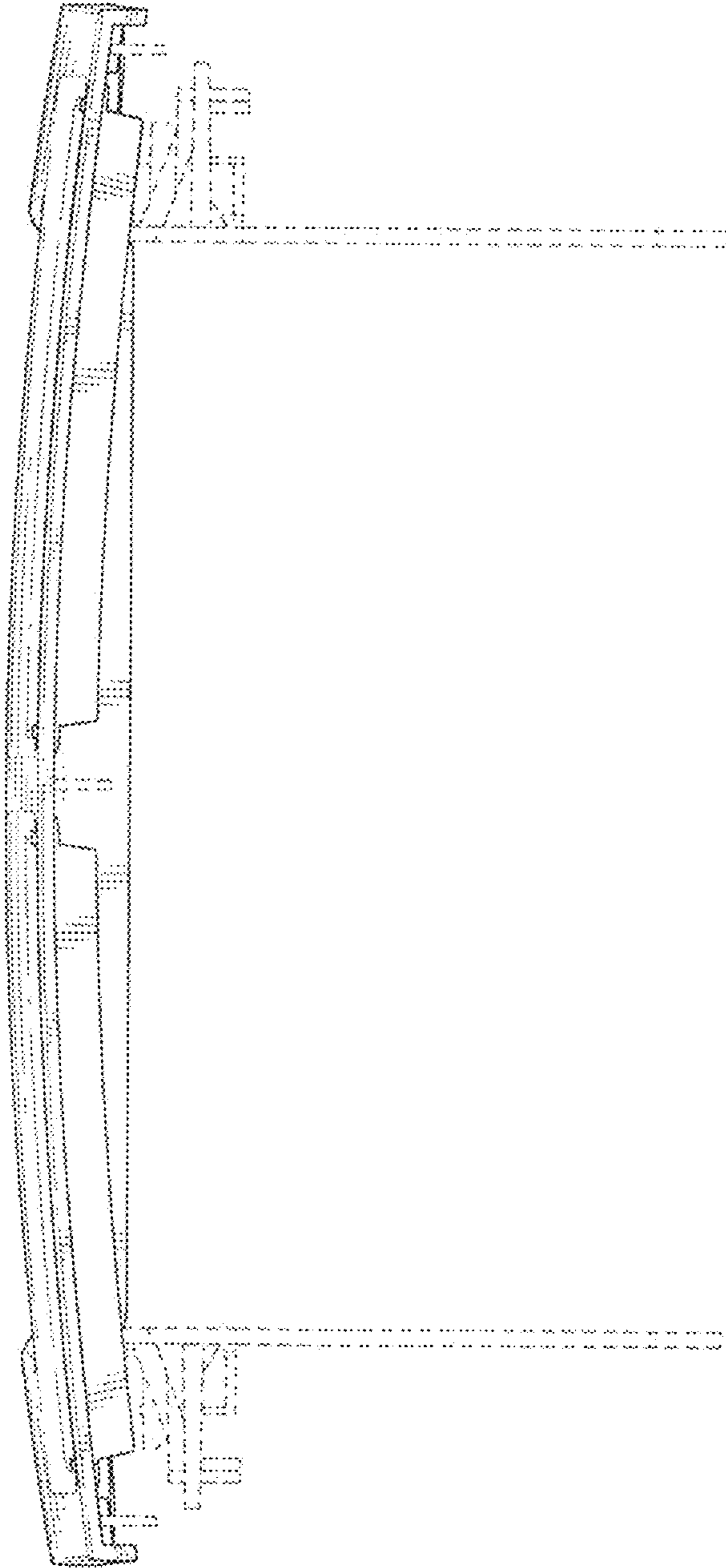

FIG. 7