



US00D878006S

(12) **United States Design Patent**
Wu

(10) **Patent No.:** **US D878,006 S**
(45) **Date of Patent:** **** Mar. 17, 2020**

(54) **CONFECTION**

(71) Applicant: **Mars, Incorporated**, McLean, VA (US)

(72) Inventor: **Jie Wu**, Guangzhou (CN)

(73) Assignee: **MARS, INCORPORATED**, McLean, VA (US)

(**) Term: **15 Years**

(21) Appl. No.: **29/677,456**

(22) Filed: **Jan. 21, 2019**

Related U.S. Application Data

(62) Division of application No. 29/572,886, filed on Aug. 1, 2016, now Pat. No. Des. 842,580.

(51) **LOC (12) Cl.** **01-01**

(52) **U.S. Cl.**
USPC **D1/127**

(58) **Field of Classification Search**

USPC D1/100-130, 199; D24/101-104;
D28/8.1, 8.2; D13/168, 171; 53/492
CPC A23G 3/54; A61K 9/2072; A61K 9/0004;
A61K 9/2095; A61K 9/209
See application file for complete search history.

(56) **References Cited**

U.S. PATENT DOCUMENTS

D53,657 S * 7/1919 Hollywood D1/127
D58,032 S * 5/1921 Lang D28/8.1

D269,715 S * 7/1983 Tovey 424/467
D414,748 S * 10/1999 Pierson D13/171
D485,421 S * 1/2004 Norton D1/127
D556,427 S * 12/2007 Kaiser D1/127
D616,642 S * 6/2010 Kim D11/79
D663,643 S * 7/2012 Saikawa D10/108
D687,105 S * 7/2013 Menting D21/386
D785,279 S * 5/2017 Bartz D1/127
D806,657 S * 1/2018 Russo D13/168
D834,991 S * 12/2018 Pandolfino D11/79
D845,931 S * 4/2019 Kosuge D14/218

* cited by examiner

Primary Examiner — Katie Jane Stofko

(57) **CLAIM**

The ornamental design for a confection, as shown and described.

DESCRIPTION

FIG. 1 is a perspective view of a confection showing my new design;
FIG. 2 is a front elevation view thereof;
FIG. 3 is a left elevation view thereof;
FIG. 4 is a right elevation view thereof;
FIG. 5 is a top plan view thereof;
FIG. 6 is a bottom plan view thereof; and,
FIG. 7 is a rear elevation view thereof.
The broken lines shown in FIG. 1-7 illustrate portions of the confection that form no part of the claimed design.

1 Claim, 1 Drawing Sheet

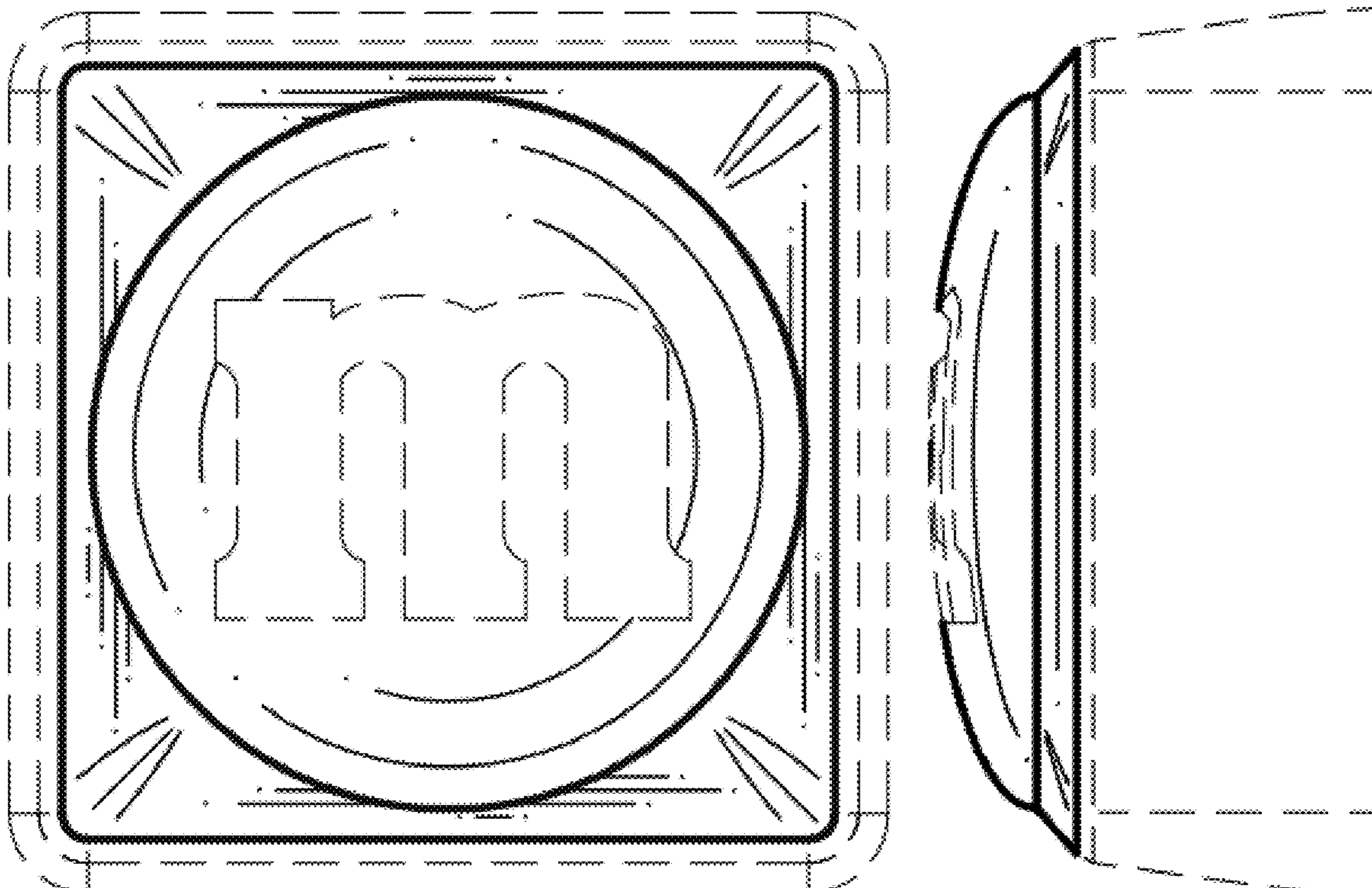

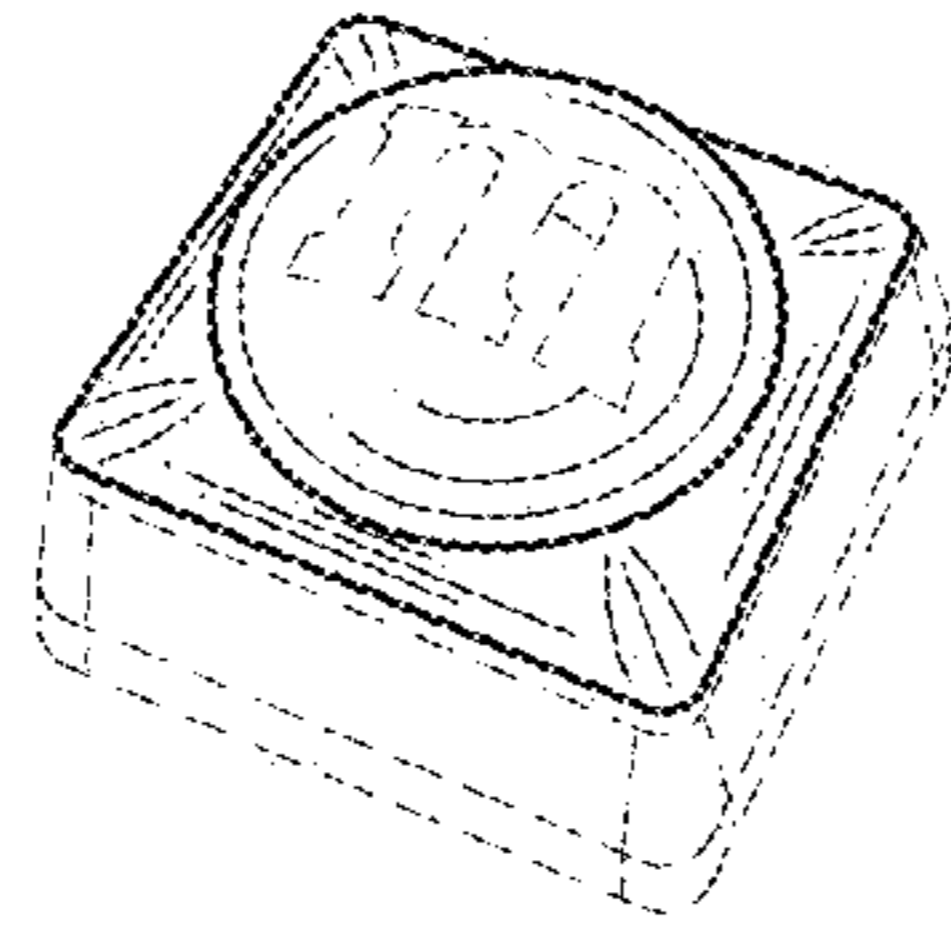

FIG. 1

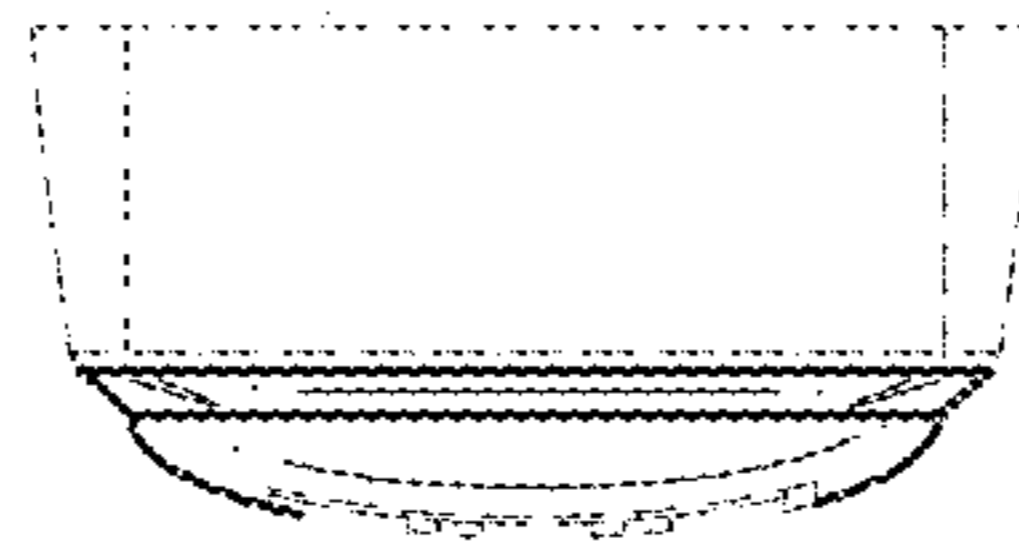

FIG. 5

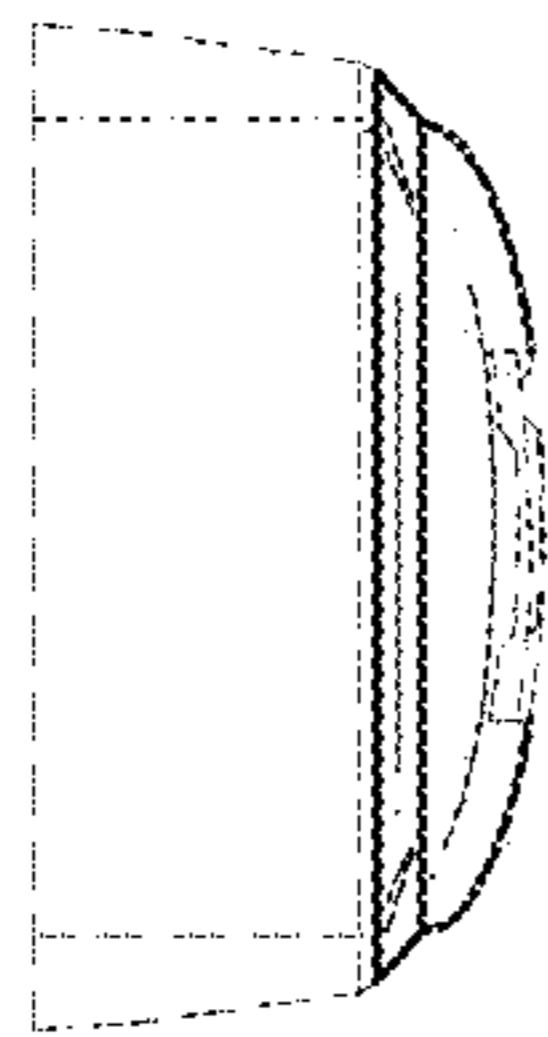

FIG. 3

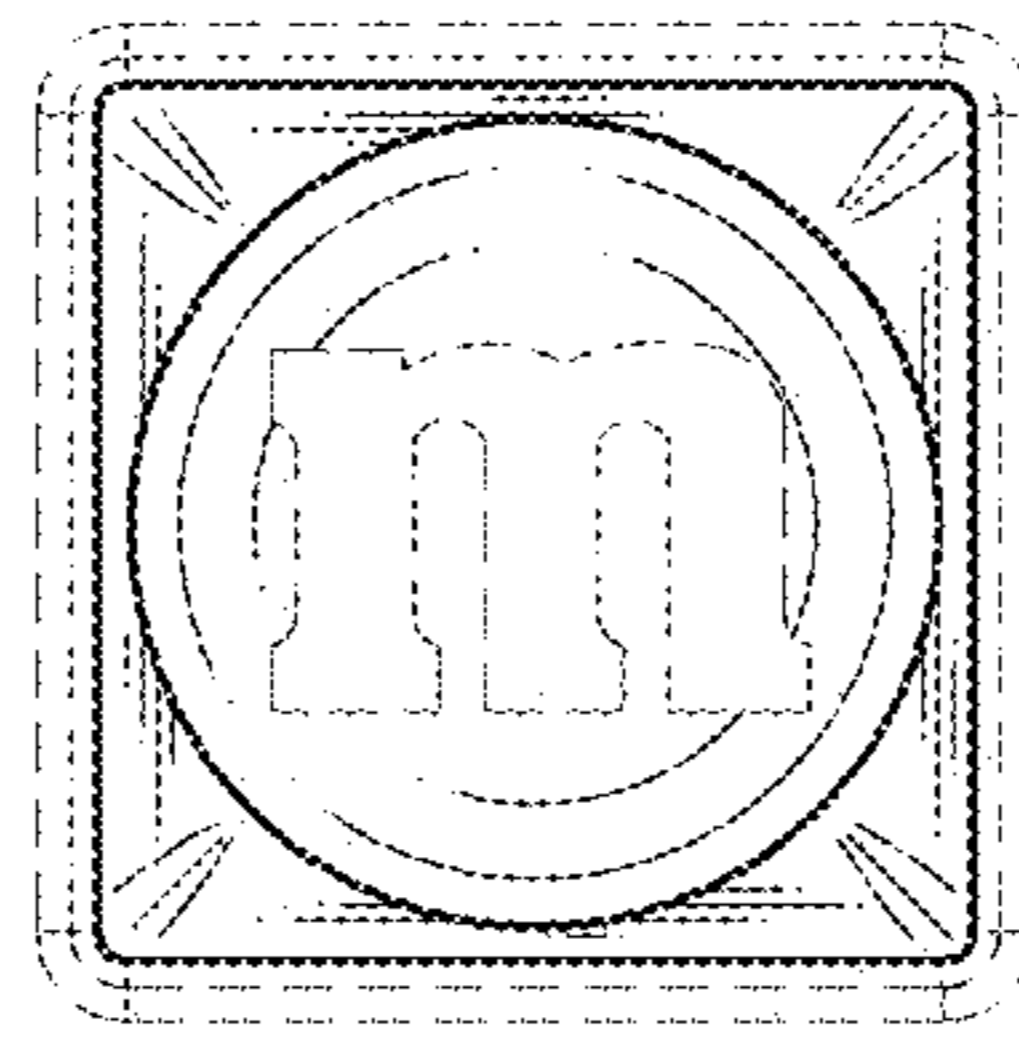

FIG. 2

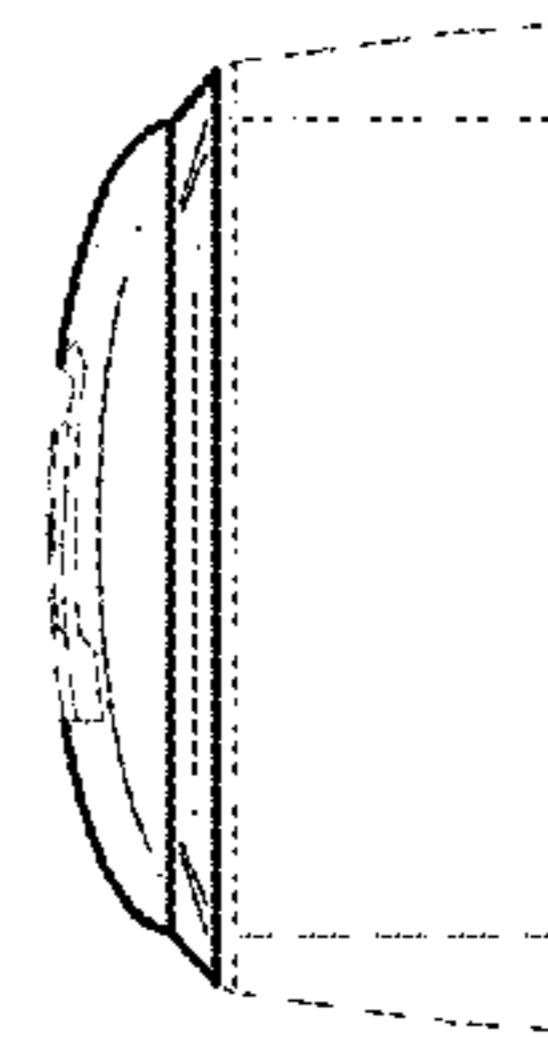

FIG. 4

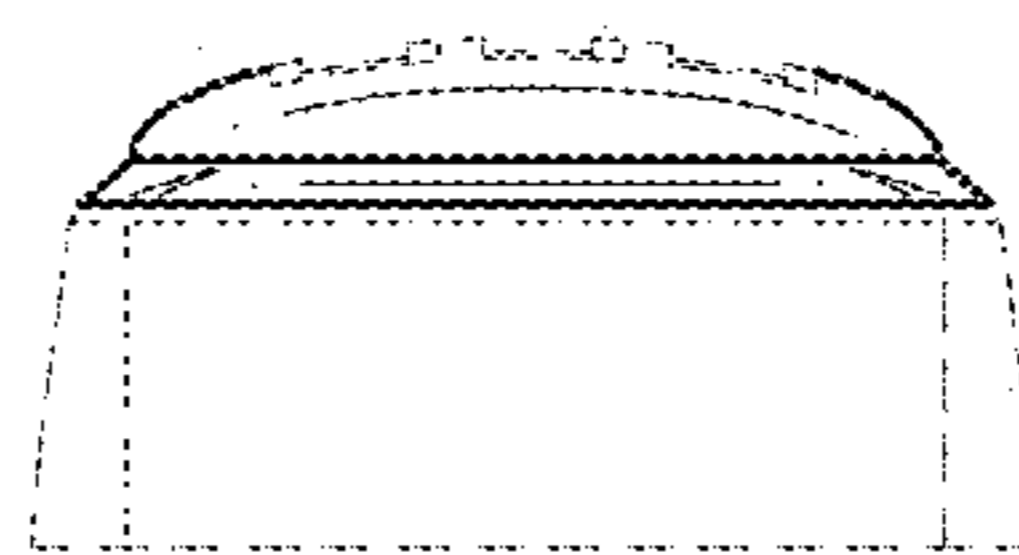

FIG. 6

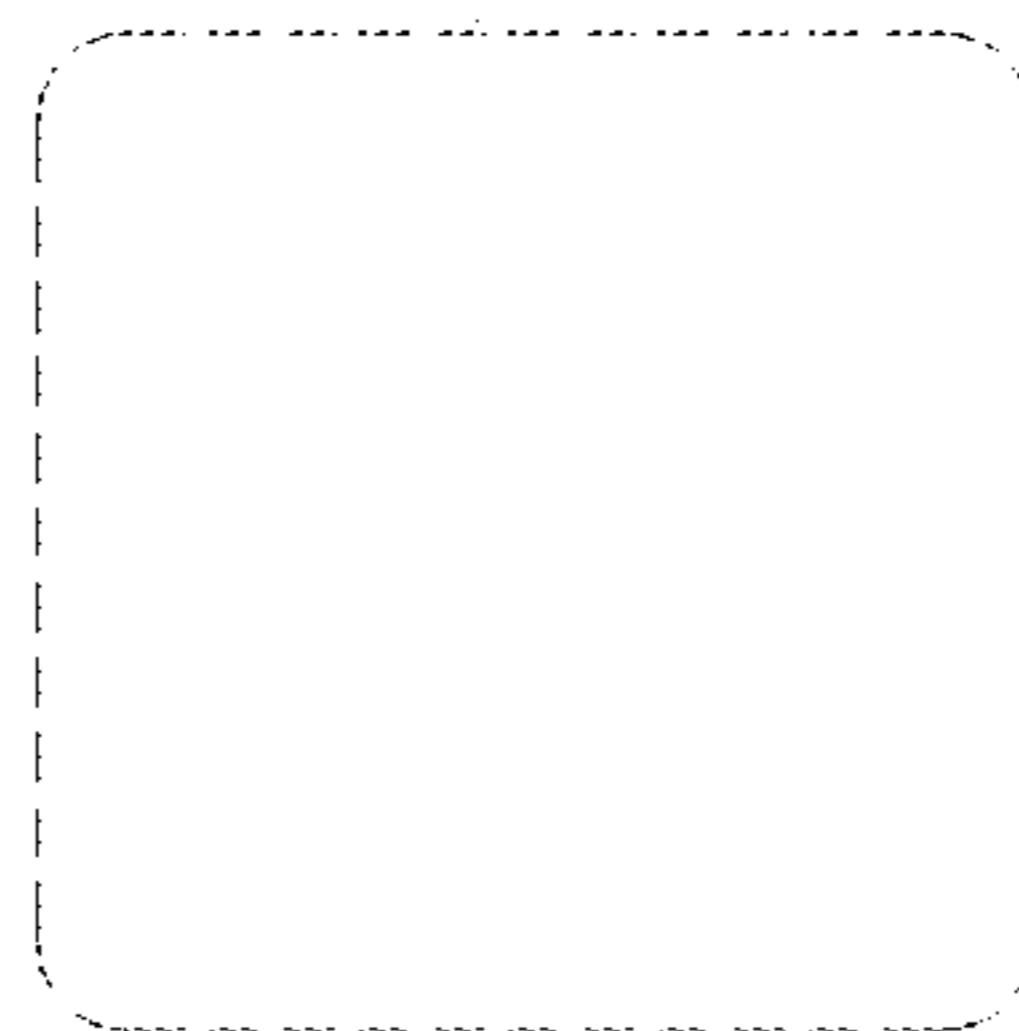

FIG. 7