



US00D877833S

(12) **United States Design Patent**  
**Yamamoto**

(10) **Patent No.:** **US D877,833 S**  
(45) **Date of Patent:** **\*\* Mar. 10, 2020**

(54) **TENNIS RACKET FRAME**

(71) Applicant: **SUMITOMO RUBBER INDUSTRIES, LTD.**, Kobe-shi, Hyogo (JP)

(72) Inventor: **Yosuke Yamamoto**, Kobe (JP)

(73) Assignee: **SUMITOMO RUBBER INDUSTRIES, LTD.**, Kobe-Shi, Hyogo (JP)

(\*\*) Term: **15 Years**

(21) Appl. No.: **29/654,806**

(22) Filed: **Jun. 27, 2018**

(30) **Foreign Application Priority Data**

Dec. 28, 2017 (JP) ..... 2017-029551  
Dec. 28, 2017 (JP) ..... 2017-029552  
Dec. 28, 2017 (JP) ..... 2017-029553

(51) **LOC (12) Cl.** ..... **21-02**

(52) **U.S. Cl.**  
USPC ..... **D21/753; D21/729**

(58) **Field of Classification Search**  
USPC ..... **D21/729-732, 753**

(Continued)

(56) **References Cited**

**U.S. PATENT DOCUMENTS**

4,194,738 A \* 3/1980 Inoue ..... A63B 49/10  
473/535  
D262,983 S \* 2/1982 Howe ..... D21/730

(Continued)

*Primary Examiner* — Mitchell I. Siegel

(74) *Attorney, Agent, or Firm* — Birch, Stewart, Kolasch & Birch, LLP

(57) **CLAIM**

The ornamental design for a tennis racket frame, as shown and described.

**DESCRIPTION**

FIG. 1 is a front view of a first embodiment of a tennis racket frame, showing my new design;

FIG. 2 is a rear view thereof;  
FIG. 3 is a top view thereof;  
FIG. 4 is a bottom view thereof;  
FIG. 5 is a left side view thereof;  
FIG. 6 is a right side view thereof;  
FIG. 7 is a cross-section along the line 7-7 in FIG. 3 thereof;  
FIG. 8 is a cross-section along the line 8-8 in FIG. 5 thereof;  
FIG. 9 is a cross-section along the line 9-9 in FIG. 5 thereof;  
FIG. 10 is a partial enlarged view along line 10-10 in FIG. 7 thereof;  
FIG. 11 is a partial enlarged view along line 11-11 in FIG. 7 thereof;  
FIG. 12 is a partial enlarged view taken from FIG. 8;  
FIG. 13 is a partial enlarged view taken from FIG. 8;  
FIG. 14 is a partial enlarged view taken from FIG. 9;  
FIG. 15 is a partial enlarged view taken from FIG. 9;  
FIG. 16 is a partial enlarged view of portion 16-16 in FIG. 12 thereof;  
FIG. 17 is a partial enlarged view of portion 17-17 in FIG. 12 thereof;  
FIG. 18 is a front view of a second embodiment of a tennis racket frame, showing my new design;  
FIG. 19 is a rear view thereof;  
FIG. 20 is a top view thereof;  
FIG. 21 is a bottom view thereof;  
FIG. 22 is a left side view thereof;  
FIG. 23 is a right side view thereof;  
FIG. 24 is a cross-section along the line 24-24 in FIG. 20 thereof;  
FIG. 25 is a cross-section along the line 25-25 in FIG. 22 thereof;  
FIG. 26 is a cross-section along the line 26-26 in FIG. 22 thereof;  
FIG. 27 is a partial enlarged view along line 27-27 in FIG. 24 thereof;  
FIG. 28 is a partial enlarged view along line 28-28 in FIG. 24 thereof;  
FIG. 29 is a partial enlarged view taken from FIG. 25;  
FIG. 30 is a partial enlarged view taken from FIG. 25;  
FIG. 31 is a partial enlarged view taken from FIG. 26;  
FIG. 32 is a partial enlarged view taken from FIG. 26;  
FIG. 33 is a partial enlarged view of portion 33-33 in FIG. 29 thereof; and,

(Continued)

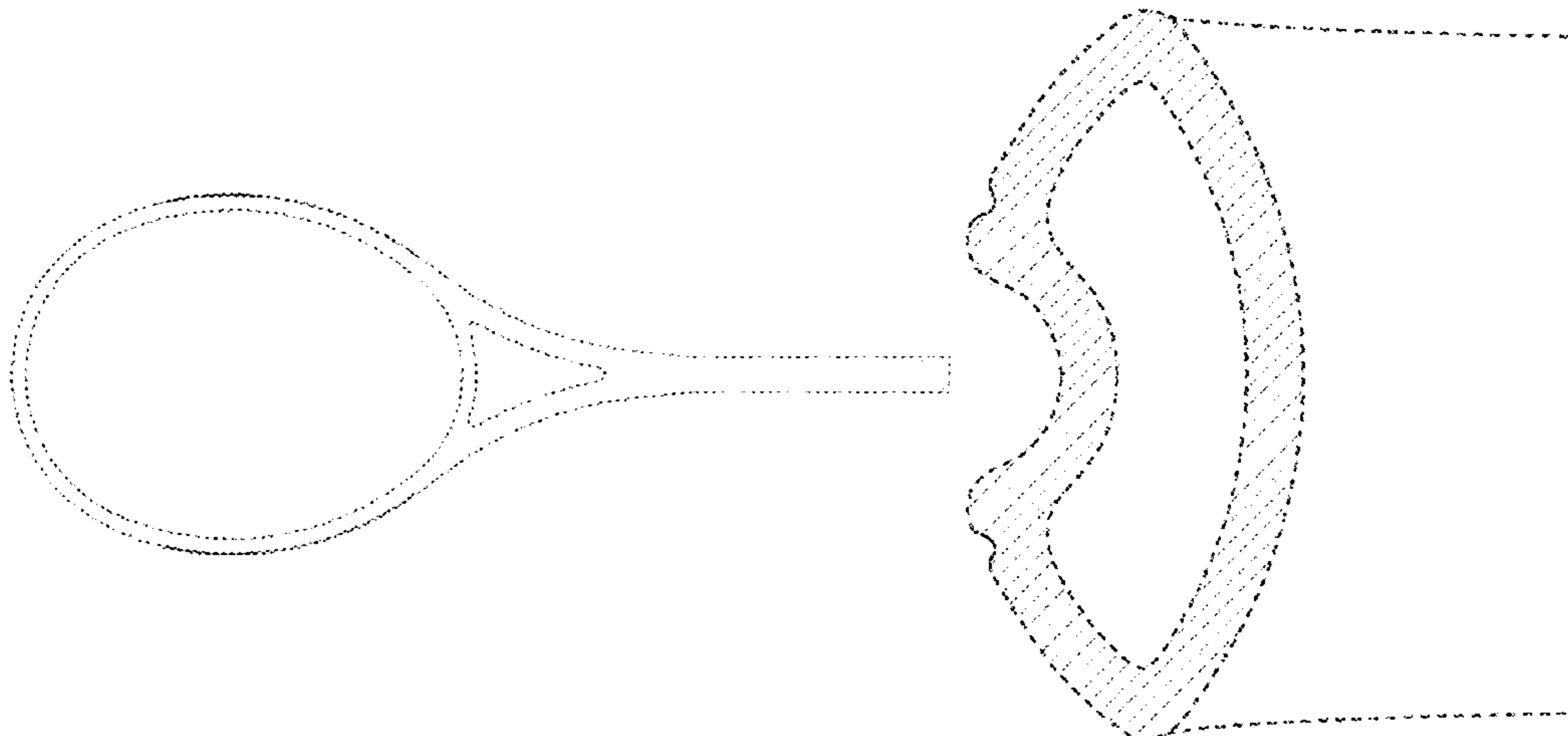

FIG. 34 is a partial enlarged view of portion 34-34 in FIG. 29 thereof.

The broken line showing of the tennis racket frame is for illustrating the environment and forms no part of the claimed design. The dash-dot line showing of the tennis racket frame is for illustrating the boundary of the design and forms no part of the claimed design.

**1 Claim, 22 Drawing Sheets**

(58) **Field of Classification Search**

CPC .... A63B 49/00-49/14; A63B 2049/0201-103;  
 A63B 59/80; A63B 59/00; A63B 59/40;  
 A63B 59/42; A63B 59/45; A63B 60/00;  
 A63B 60/46; A63B 51/00; A63B  
 2102/00; A63B 2102/10; A63B 2102/12;  
 A63B 2102/16; A63B 2102/26; A63B  
 2102/28; A63B 2102/30; A63B 2102/38

See application file for complete search history.

(56) **References Cited**

U.S. PATENT DOCUMENTS

D263,729 S \* 4/1982 Bash ..... D21/730  
 D273,507 S \* 4/1984 Yoneyama ..... D21/730

D305,922 S \* 2/1990 Mercado ..... D21/730  
 D460,135 S \* 7/2002 Lammer ..... D21/730  
 D468,380 S \* 1/2003 Lammer ..... D21/730  
 6,530,851 B2 \* 3/2003 Munster ..... A63B 49/022  
 473/521  
 6,688,997 B2 \* 2/2004 Ashino ..... A63B 49/03  
 473/521  
 D488,844 S \* 4/2004 Szelenyi ..... D21/729  
 D502,517 S \* 3/2005 Severa ..... D21/729  
 6,964,624 B2 \* 11/2005 Shen ..... A63B 49/02  
 473/521  
 7,104,905 B2 \* 9/2006 Schwenger ..... A63B 49/02  
 473/521  
 7,137,912 B2 \* 11/2006 Ashino ..... A63B 49/02  
 473/537  
 D559,927 S \* 1/2008 McMillan ..... D21/730  
 D596,682 S \* 7/2009 Severa ..... D21/730  
 D717,891 S \* 11/2014 Aubin ..... D21/730  
 D719,227 S \* 12/2014 Severa ..... D21/753  
 D719,228 S \* 12/2014 Severa ..... D21/753  
 9,533,198 B2 \* 1/2017 Yamamoto ..... A63B 49/035  
 D813,962 S \* 3/2018 Yu ..... D21/729  
 10,245,473 B2 \* 4/2019 Yamamoto ..... A63B 49/10  
 2006/0052187 A1 \* 3/2006 Pai ..... A63B 49/02  
 473/546  
 2015/0224370 A1 \* 8/2015 Yamamoto ..... A63B 49/10  
 473/535  
 2019/0184243 A1 \* 6/2019 Yamamoto ..... A63B 49/14

\* cited by examiner

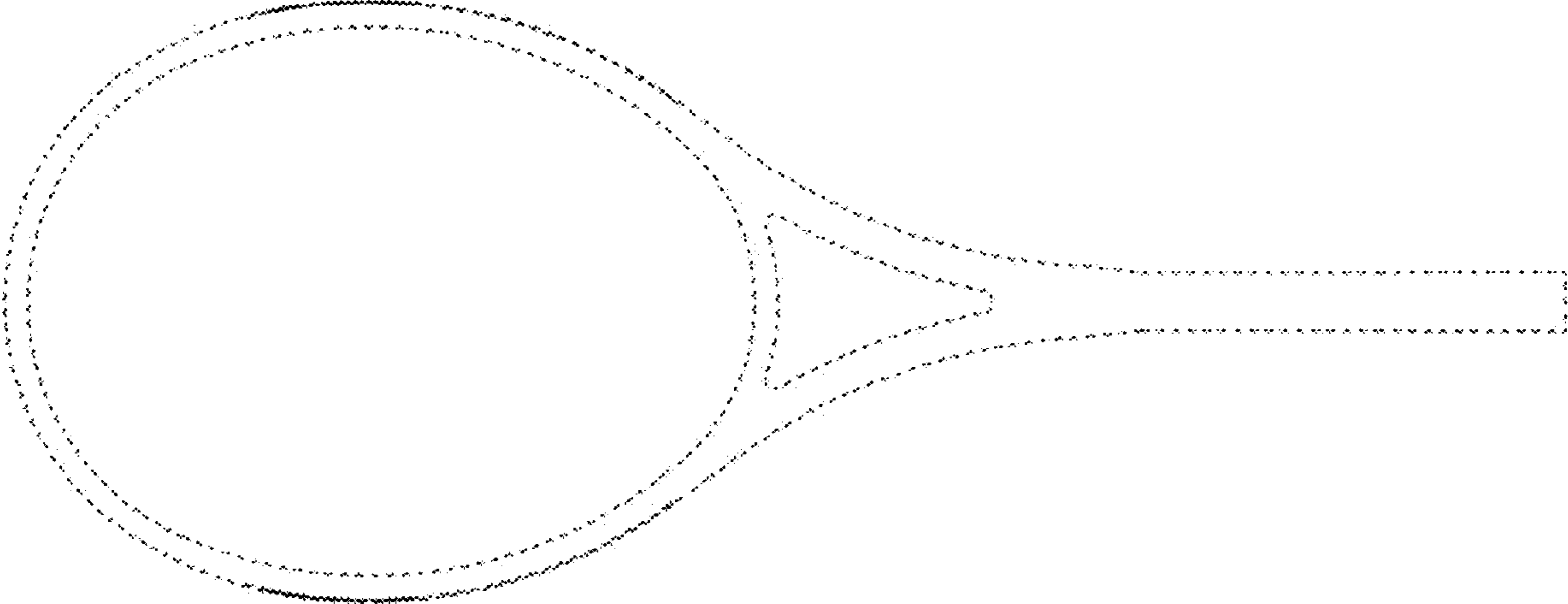

FIG. 1

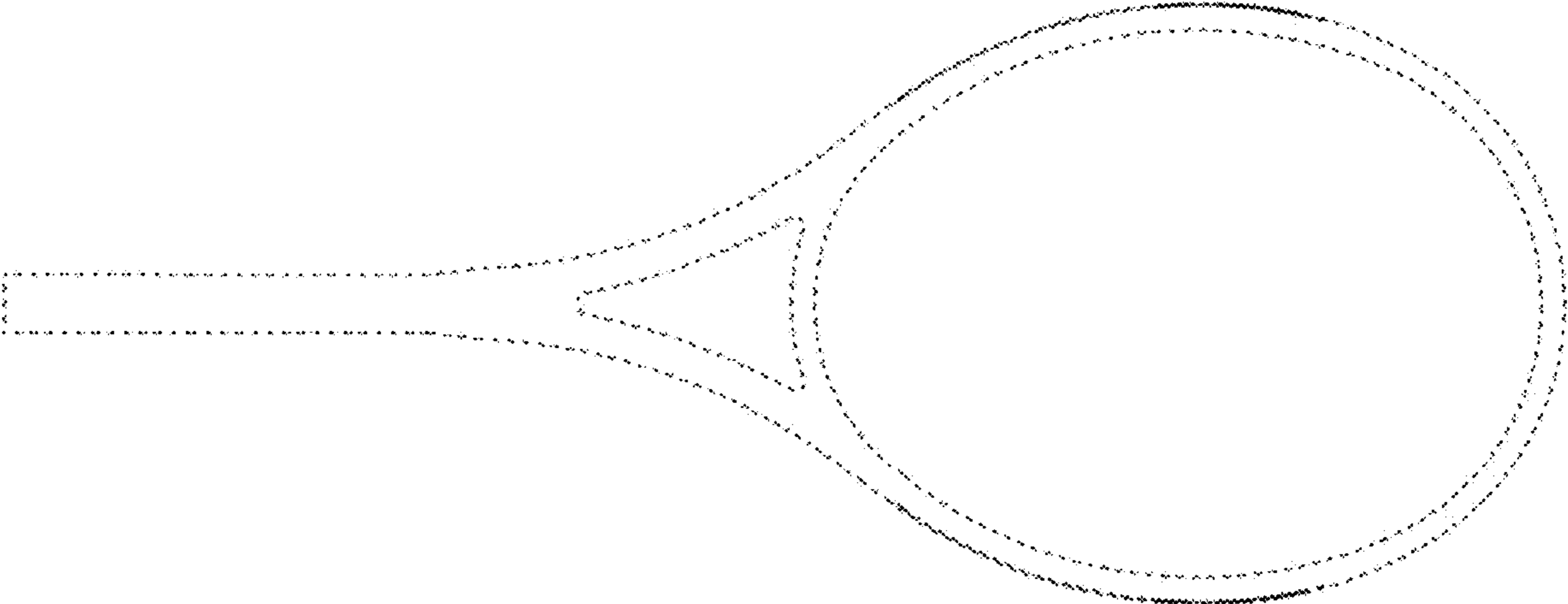

FIG. 2

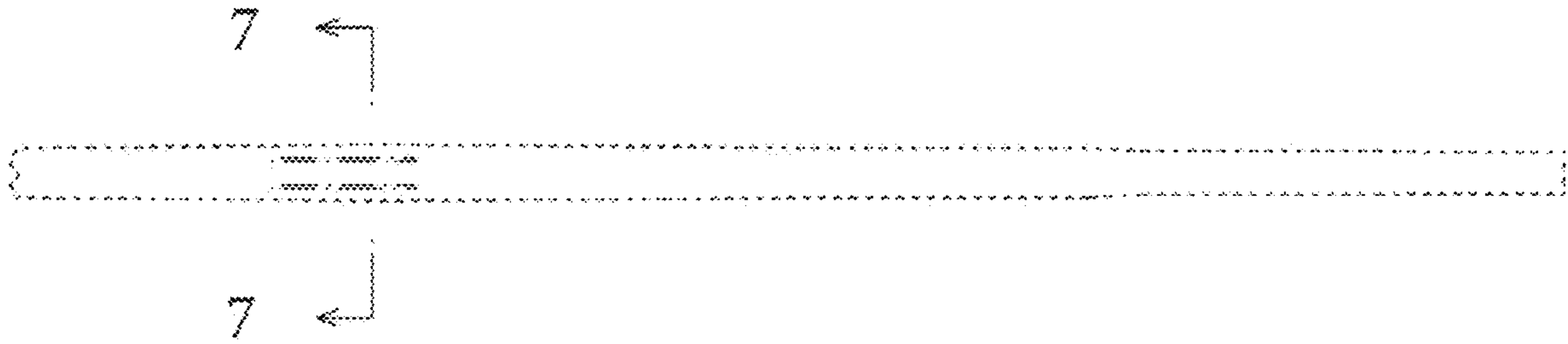

FIG. 3

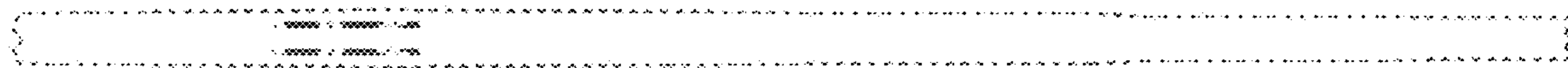

FIG. 4

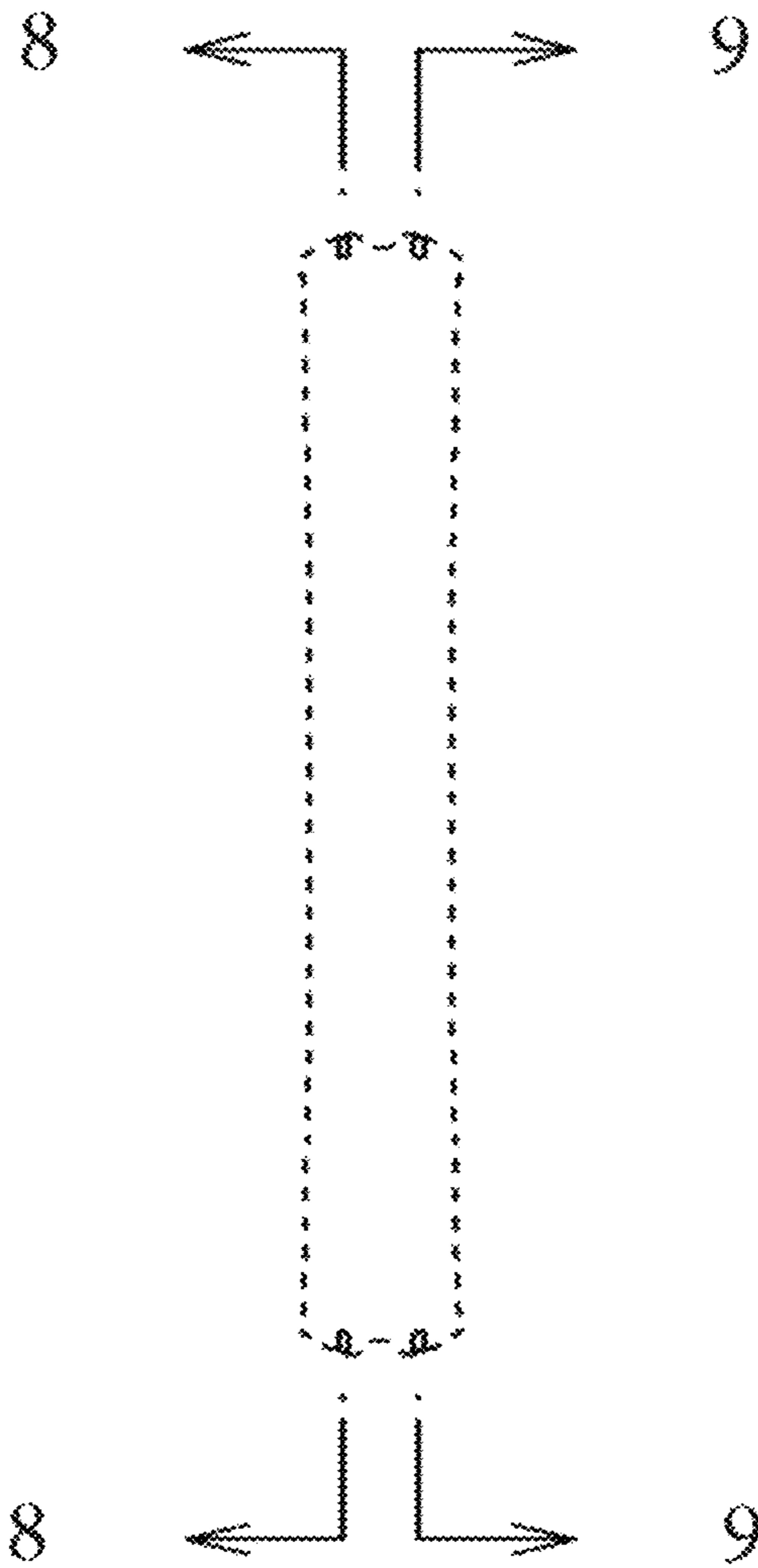

FIG. 5



FIG. 6

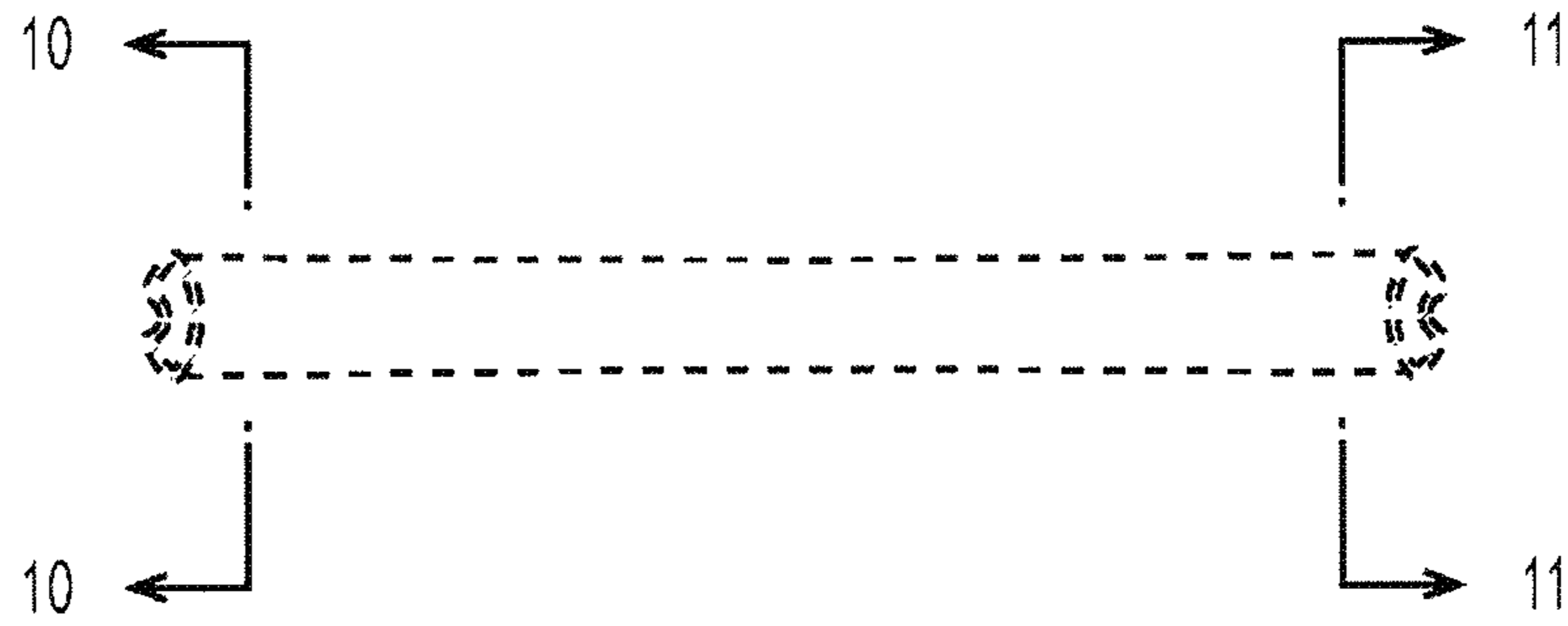

FIG. 7

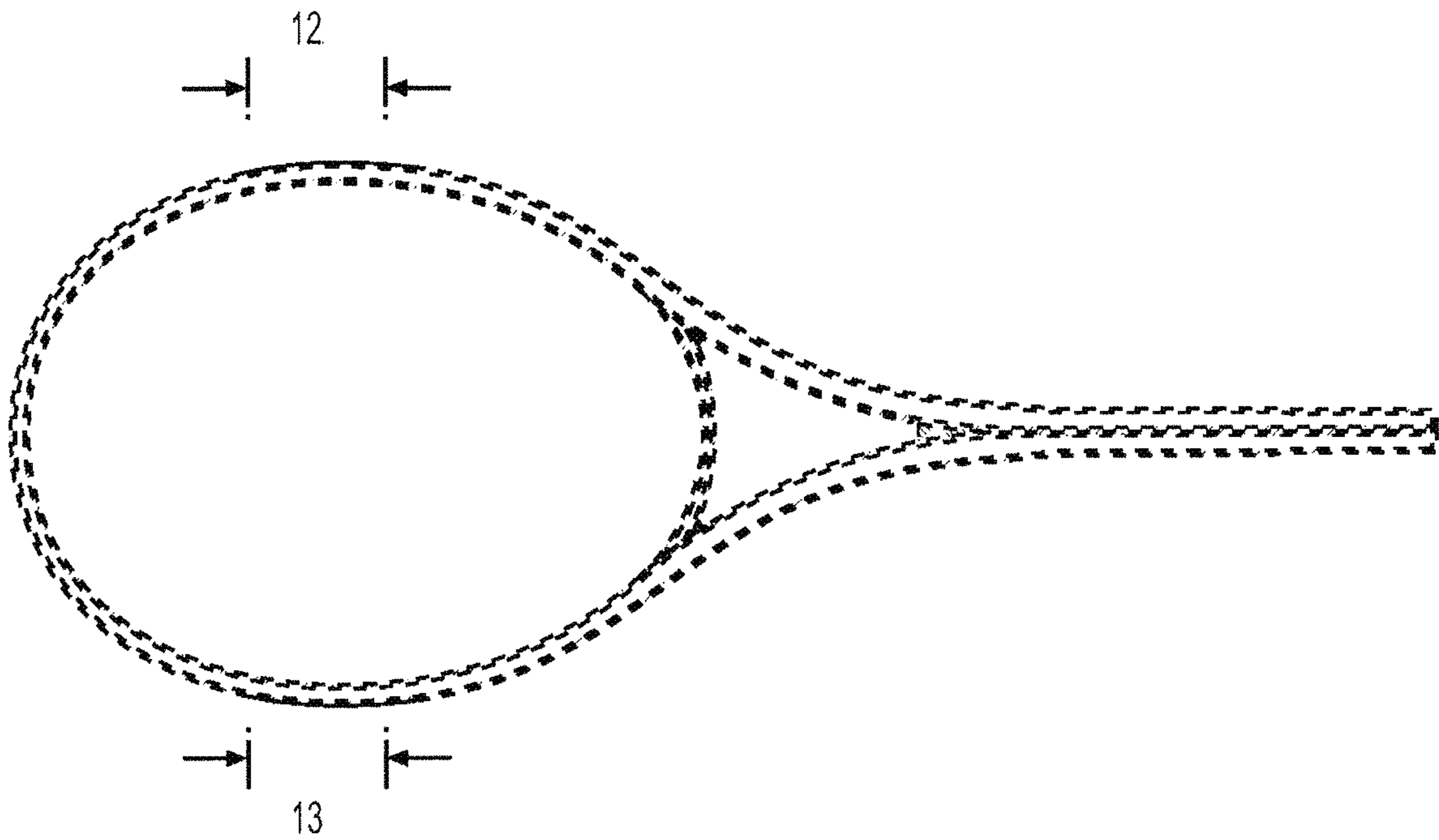

FIG. 8

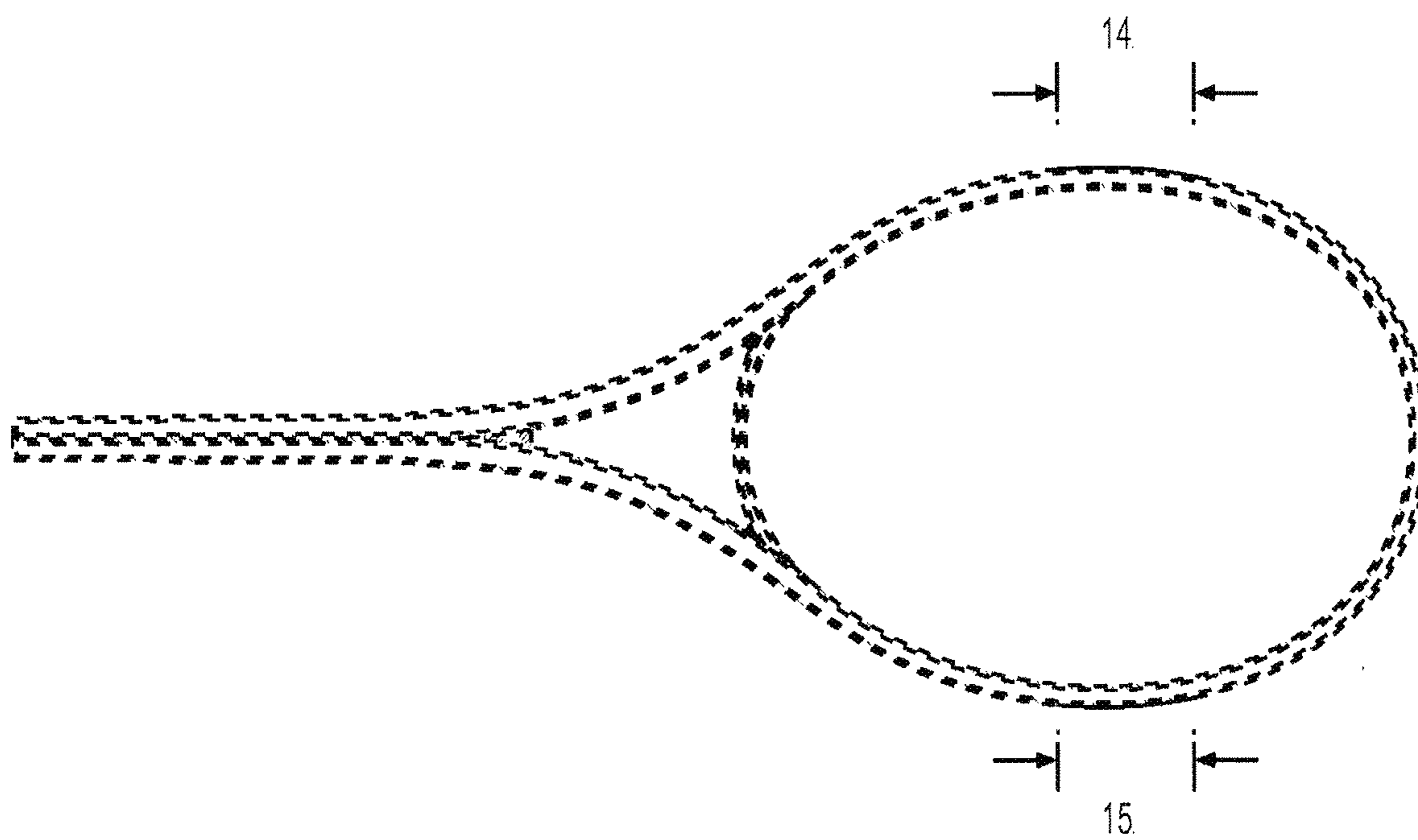

FIG. 9



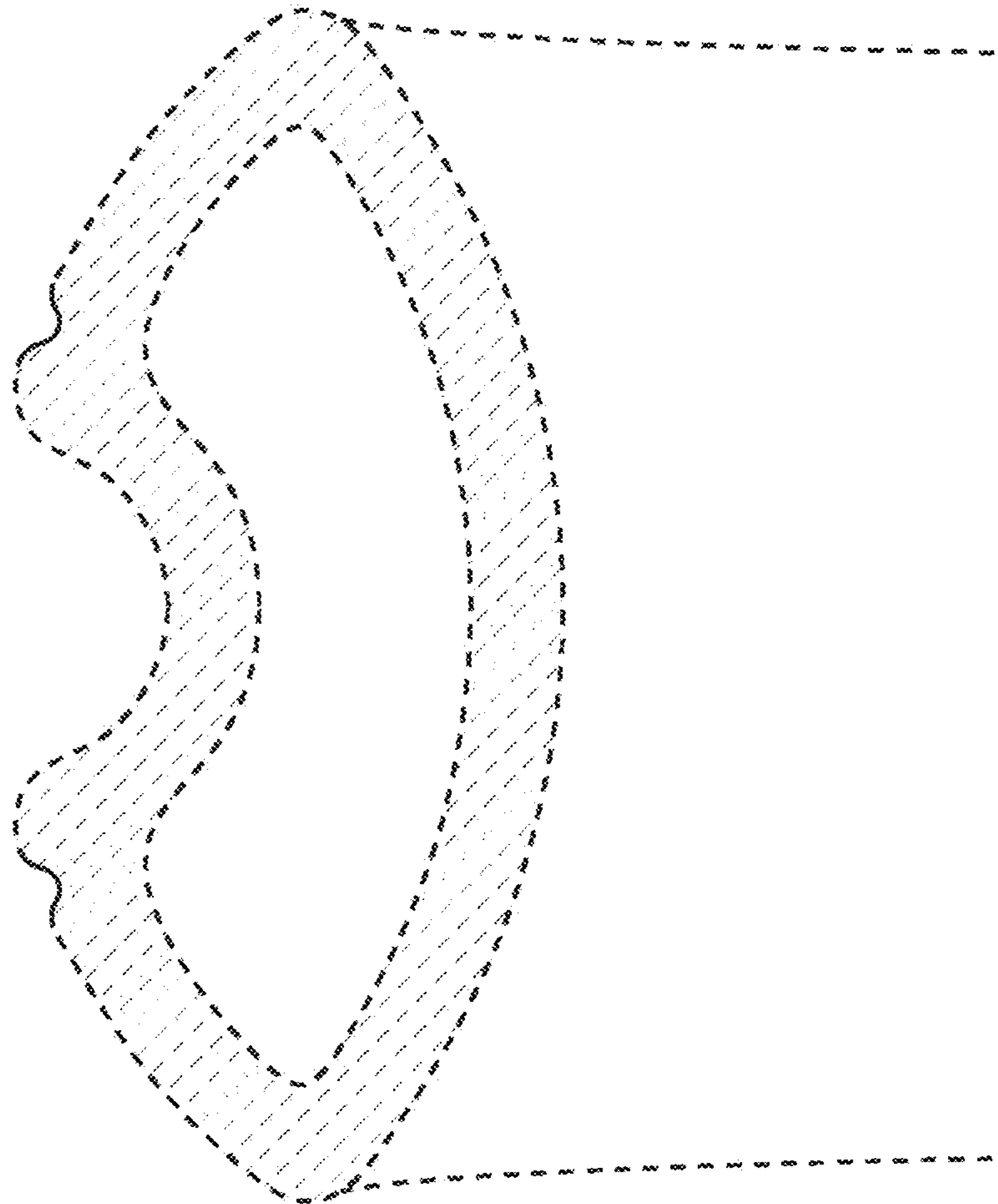

FIG. 10

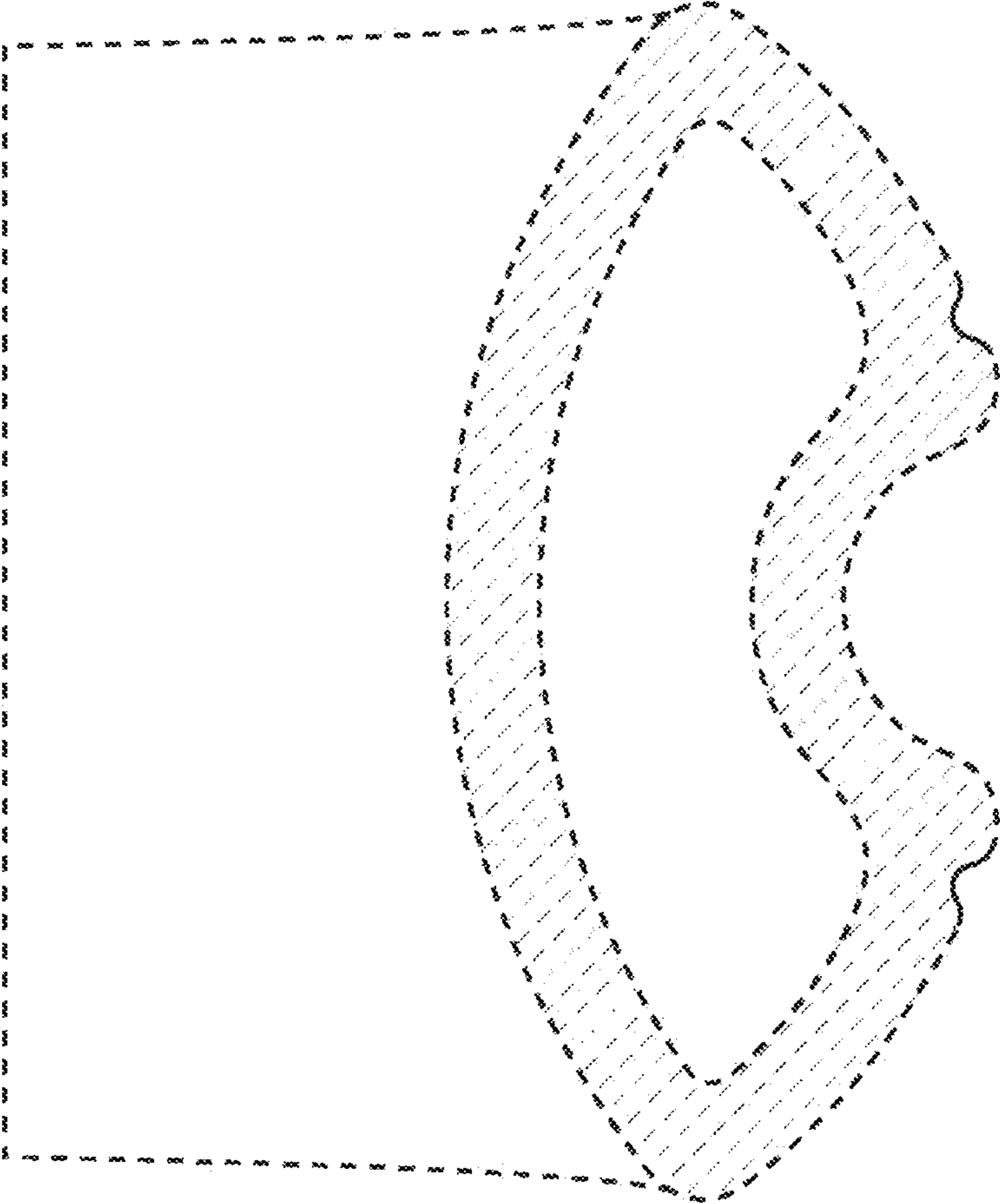

FIG. 11

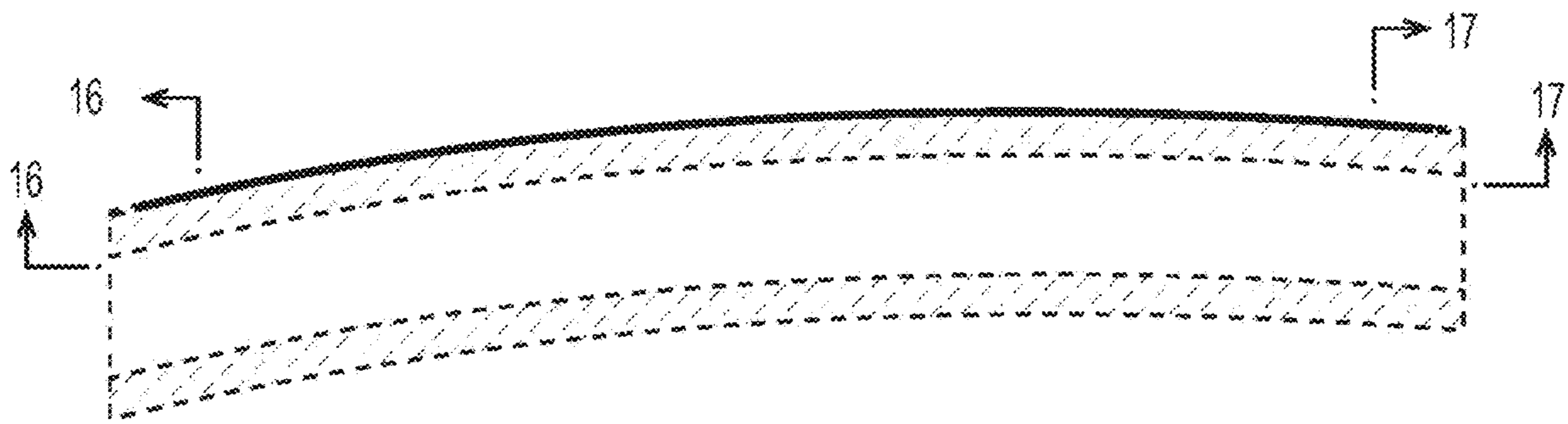

FIG. 12

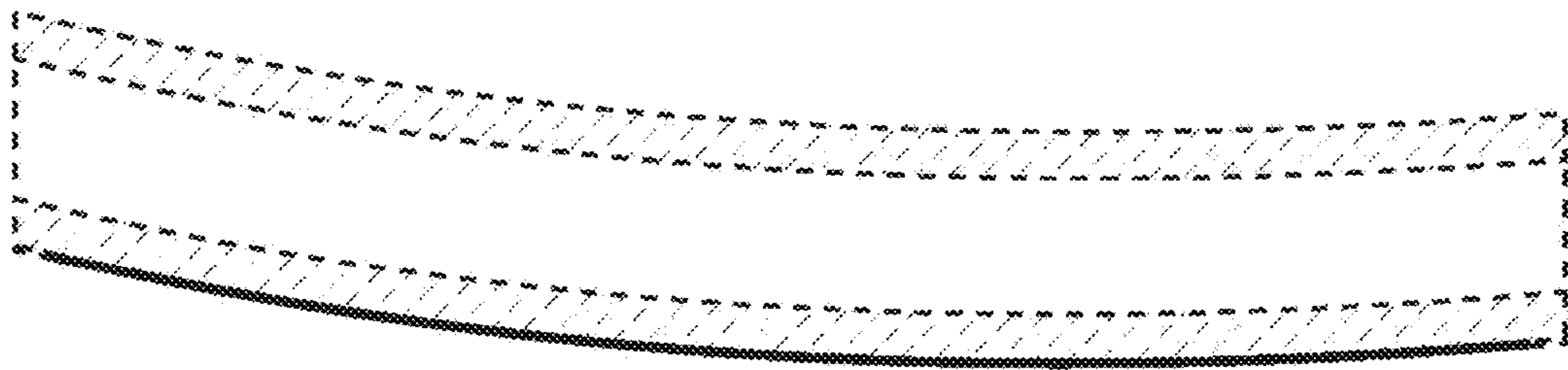

FIG. 13

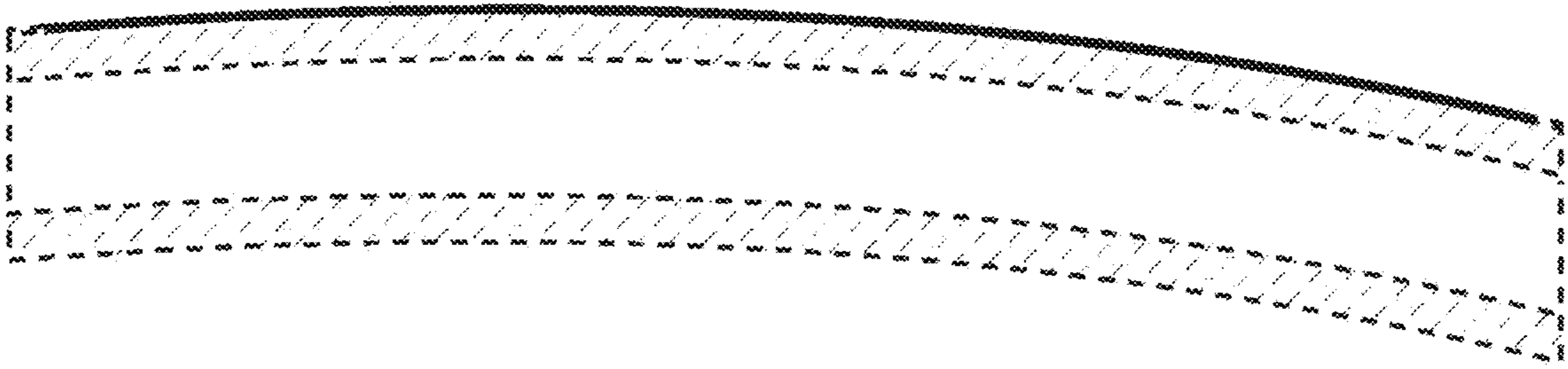

FIG. 14

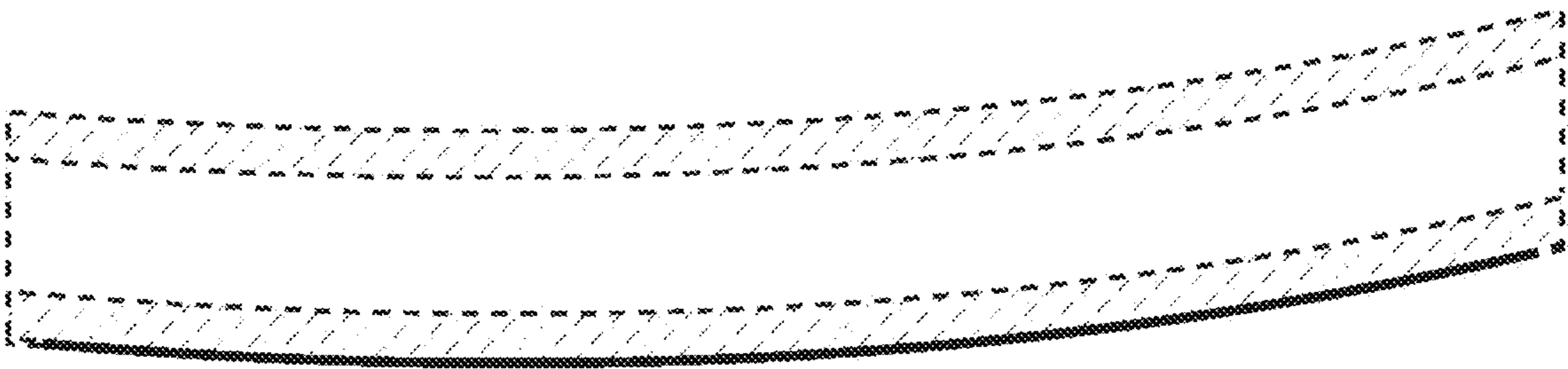

FIG. 15

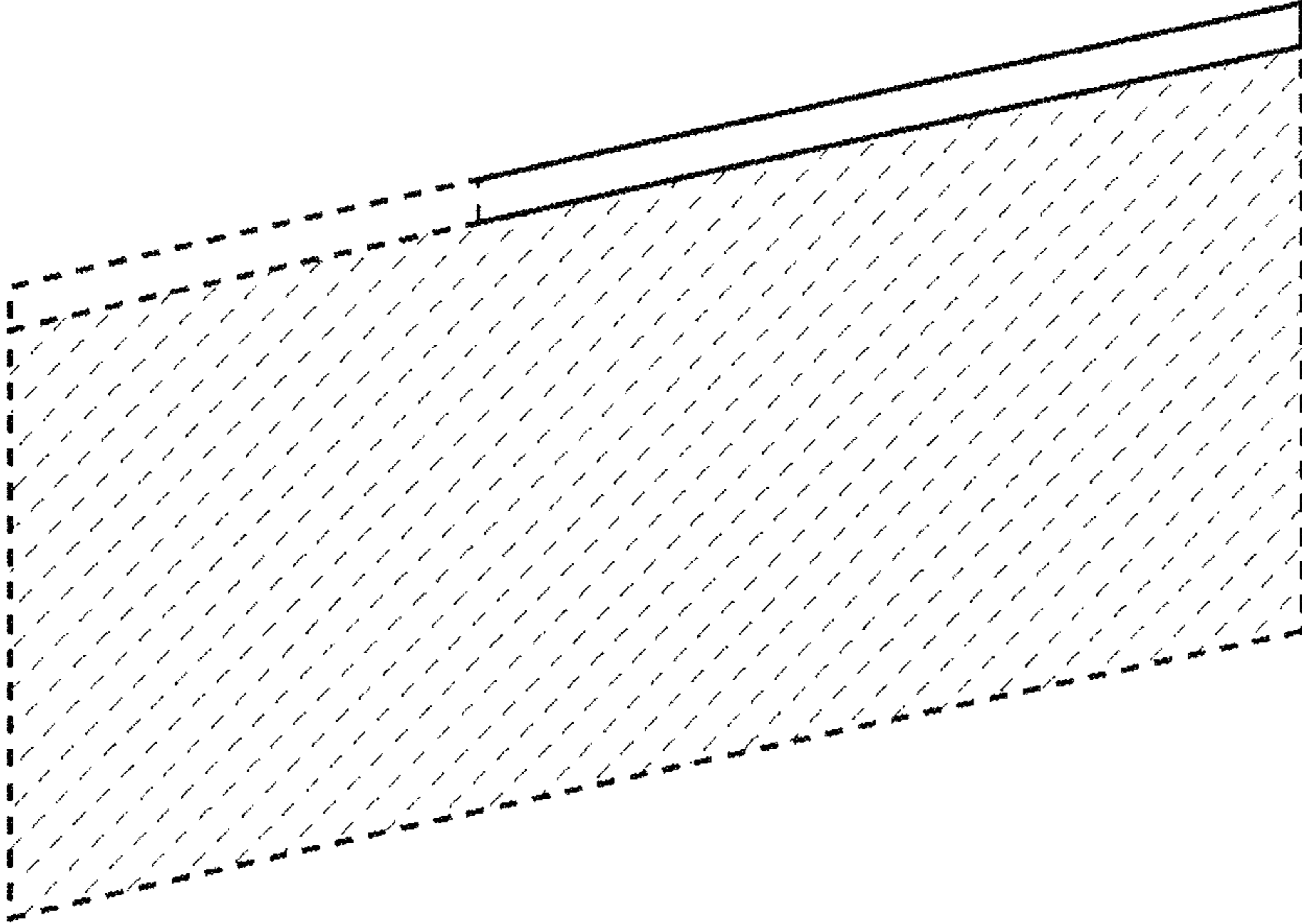

FIG. 16

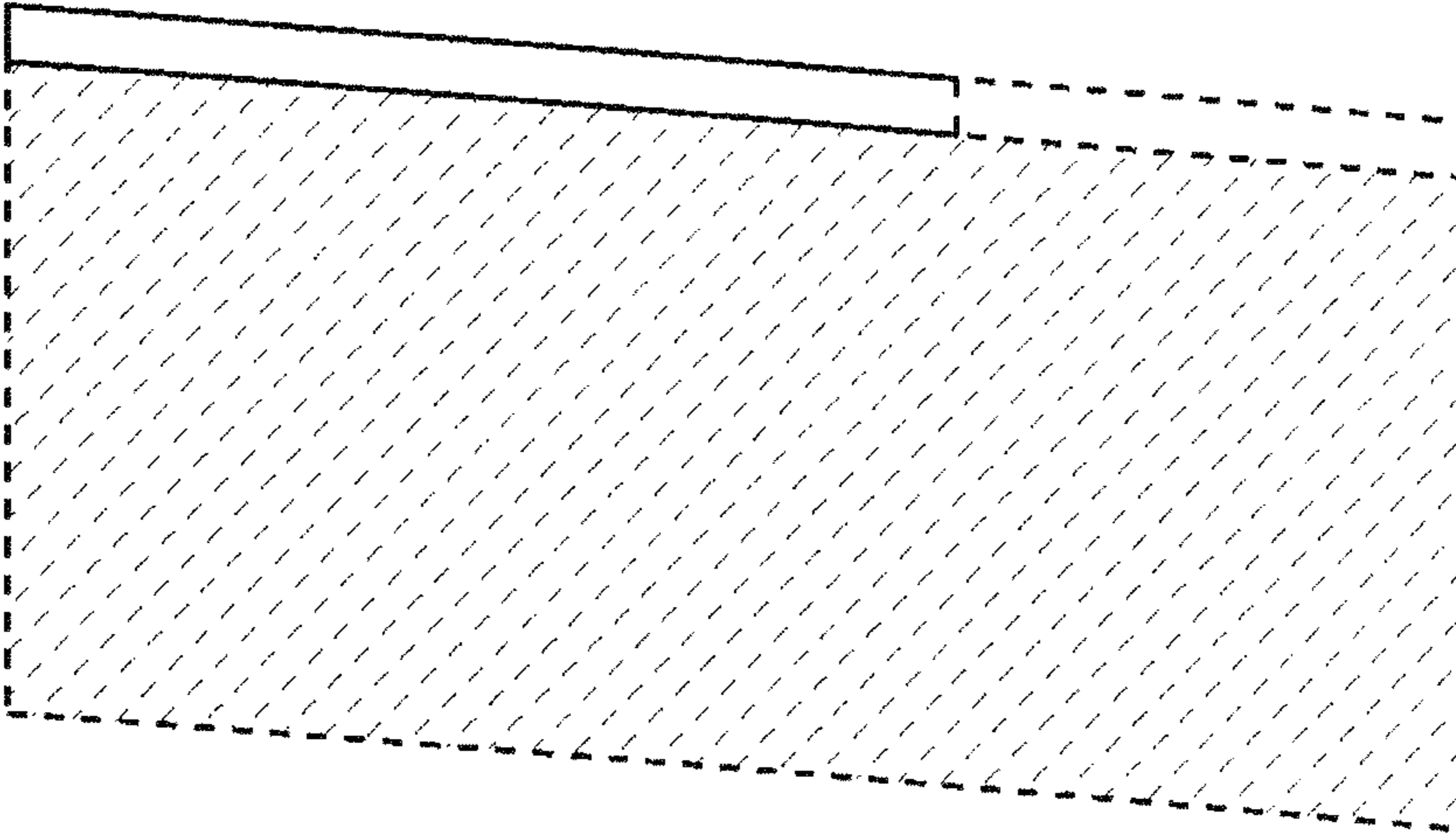

FIG. 17

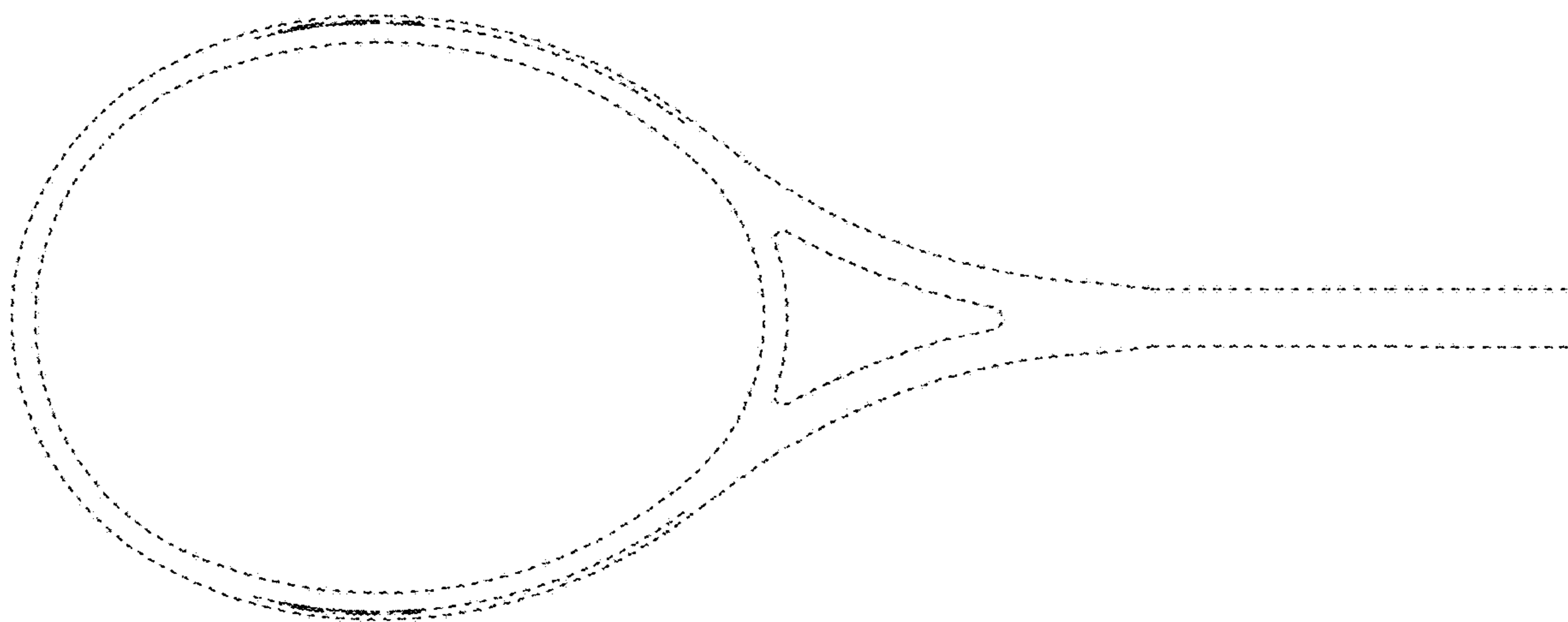

FIG. 18

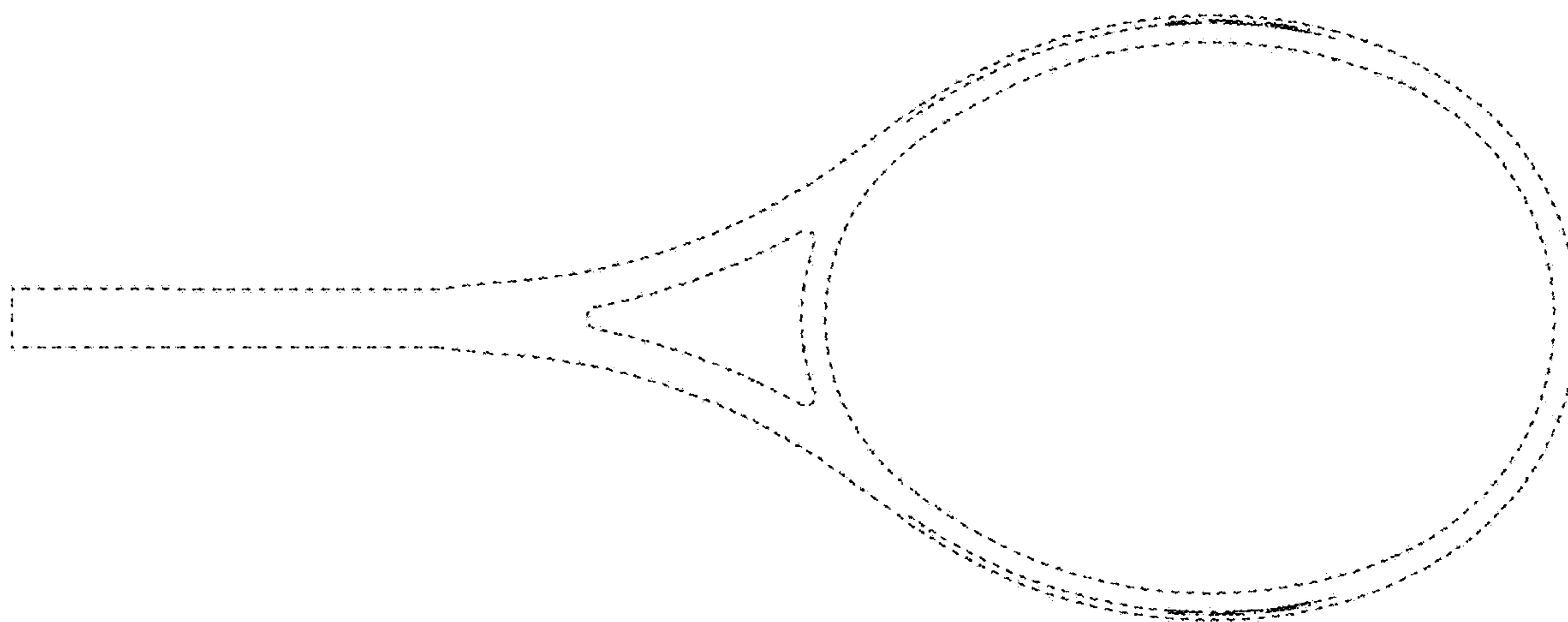

FIG. 19

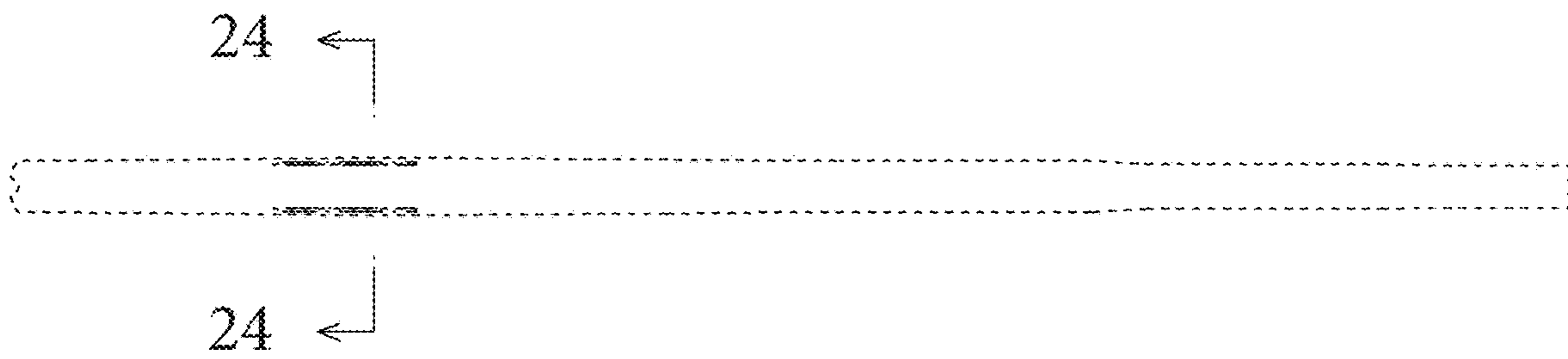

FIG. 20



FIG. 21

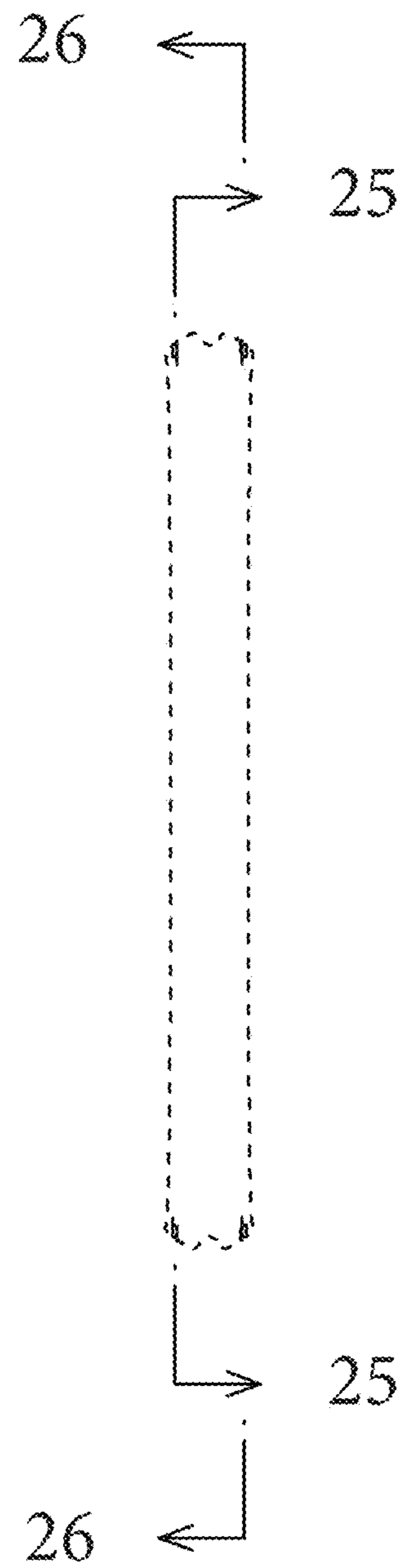

FIG. 22





FIG. 23

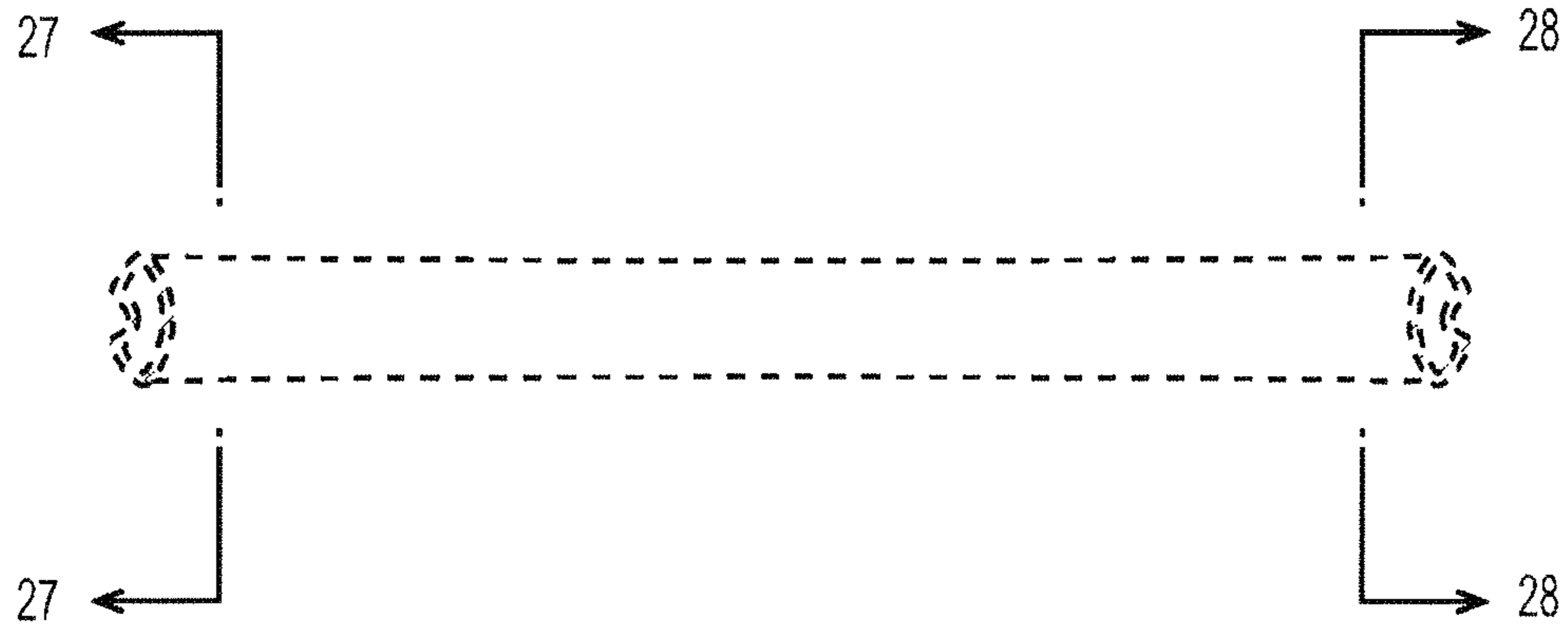

FIG. 24

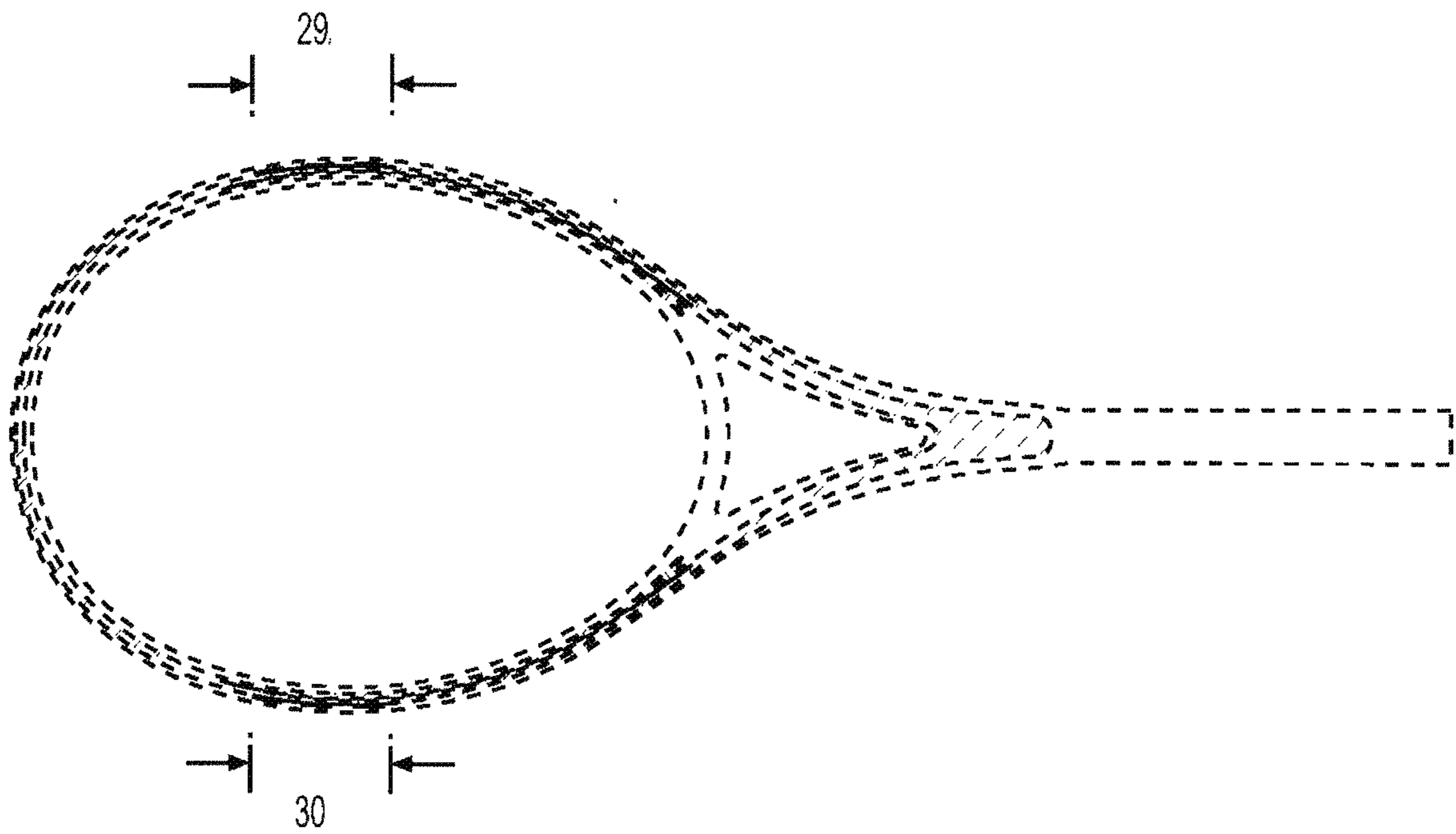

FIG. 25

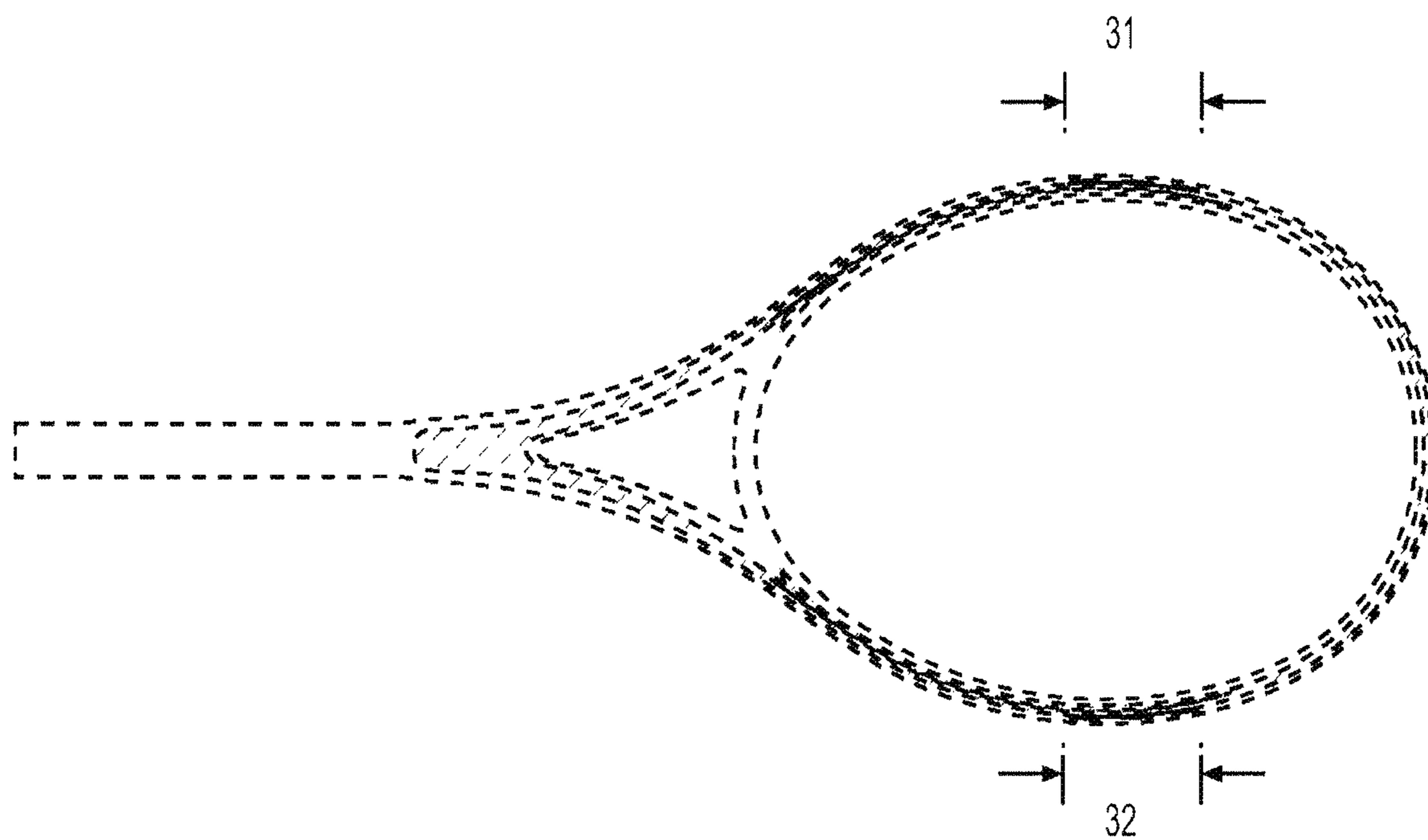

FIG. 26

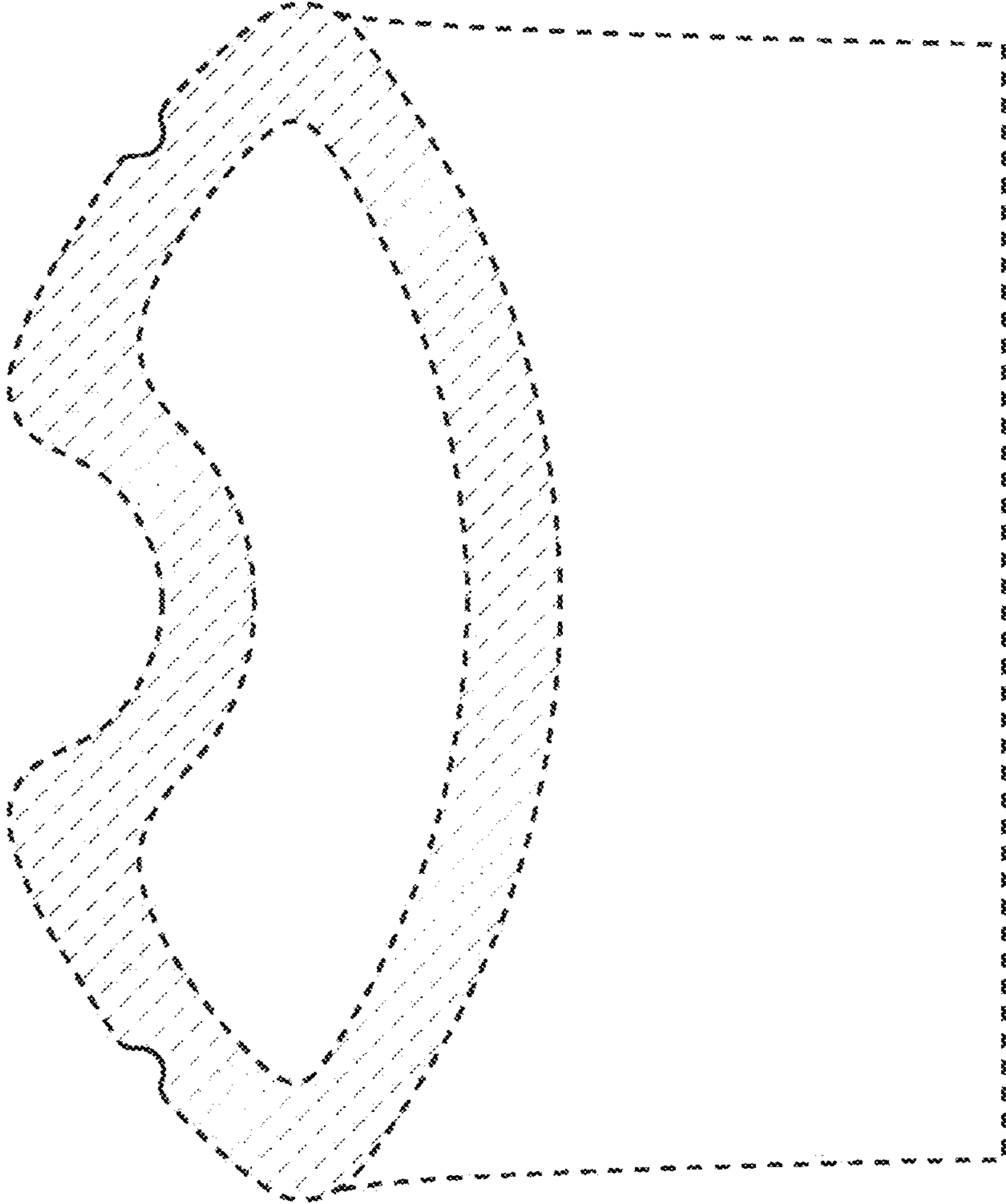

FIG. 27

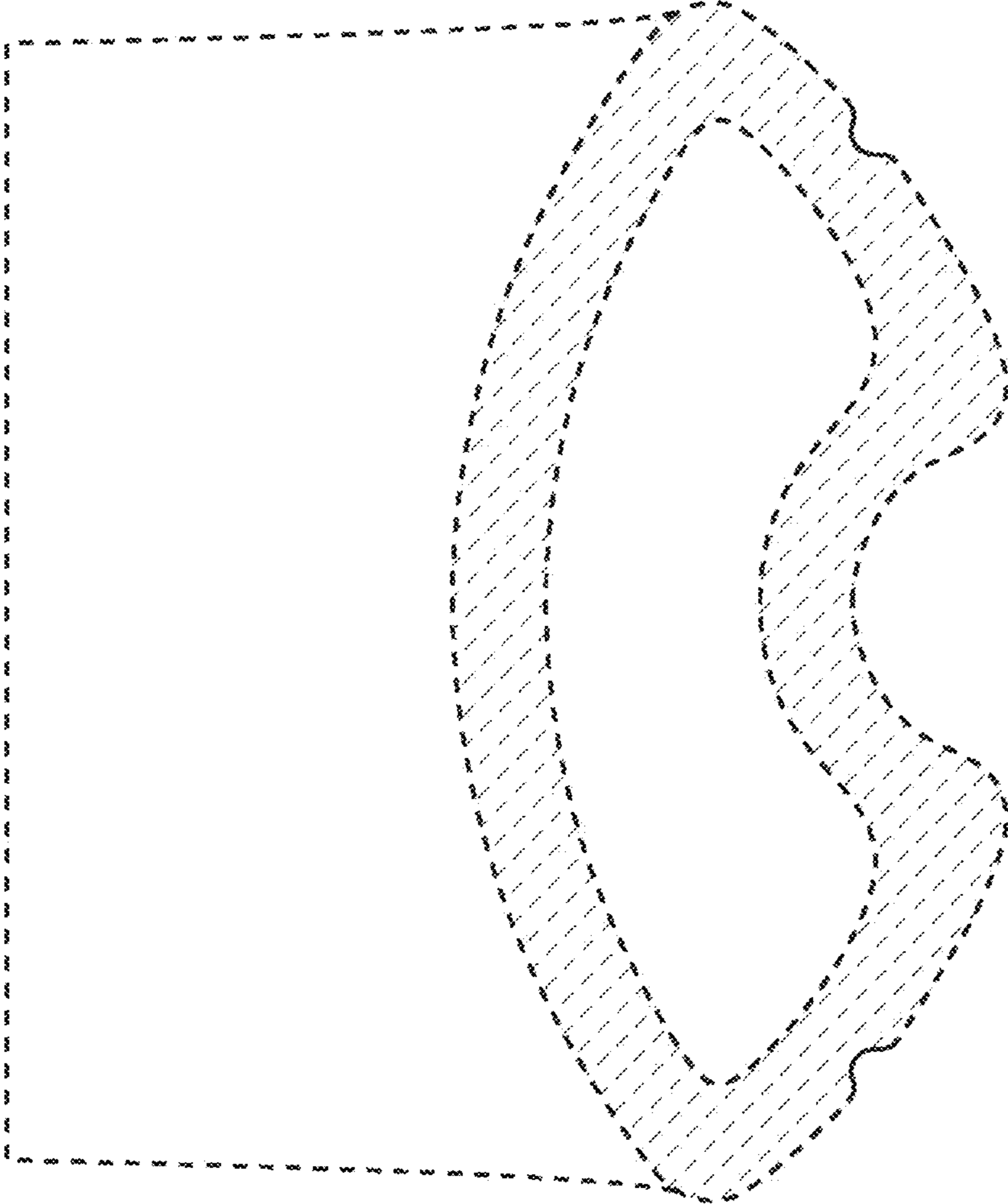

FIG. 28

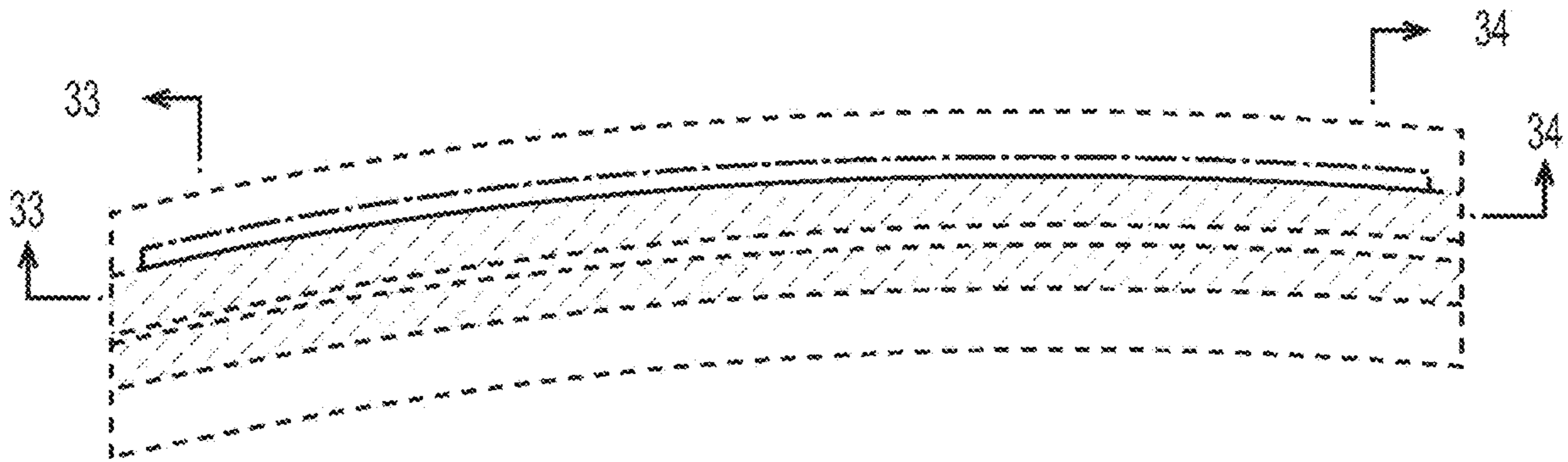

FIG. 29

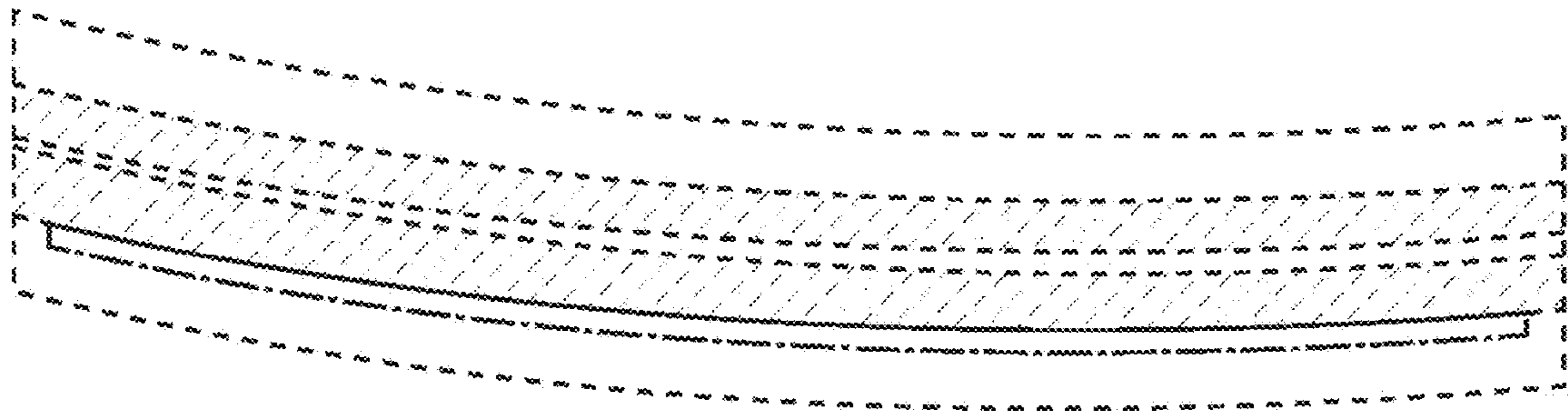

FIG. 30

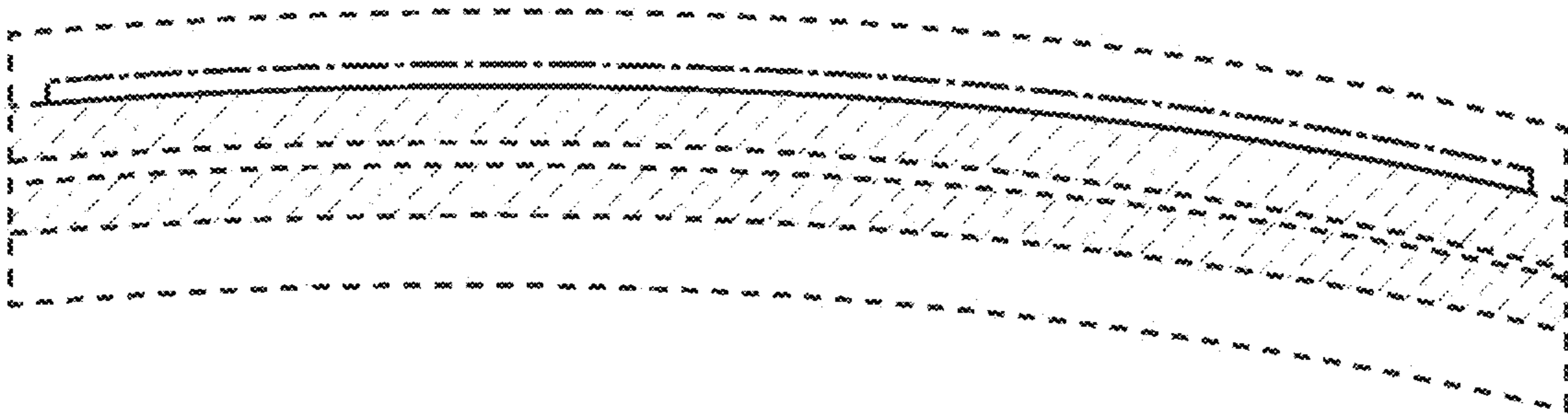

FIG. 31

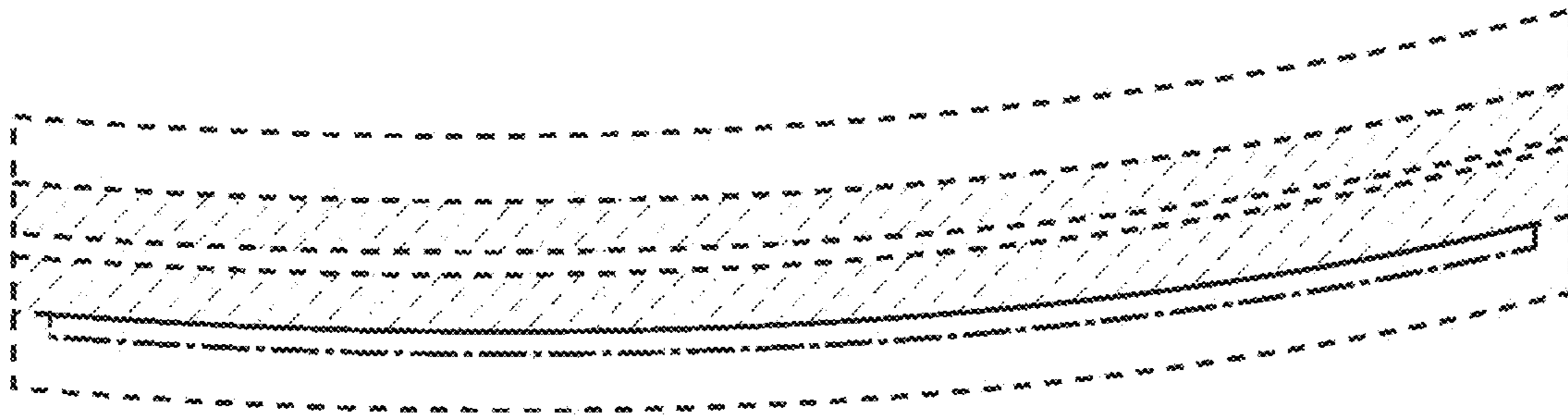

FIG. 32

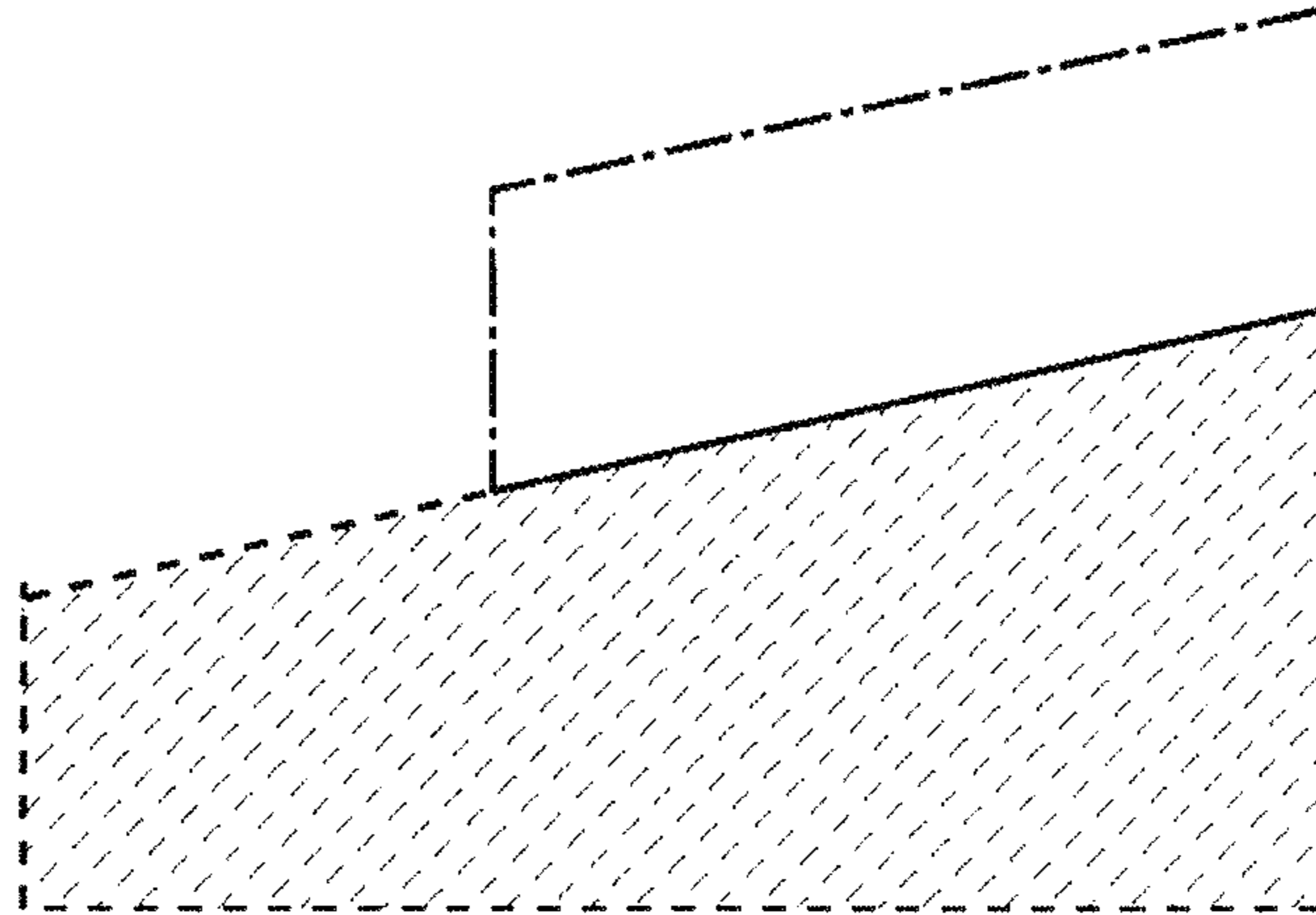

FIG. 33

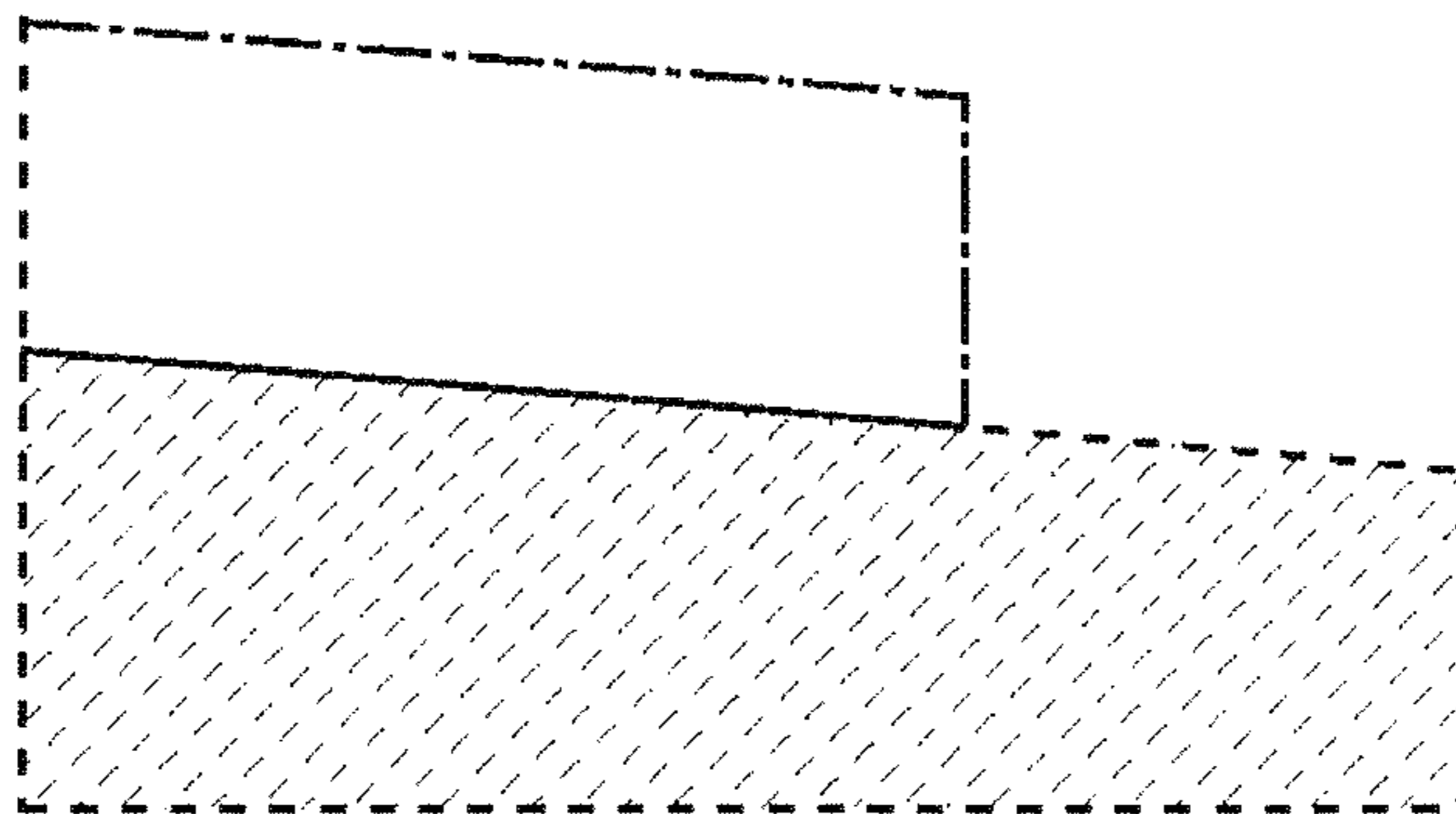

FIG. 34