

US00D877734S

(12) **United States Design Patent**  
**Cha et al.**

(10) **Patent No.:** **US D877,734 S**  
(45) **Date of Patent:** **\*\* Mar. 10, 2020**

(54) **COMPUTER**

(71) Applicant: **HEWLETT-PACKARD DEVELOPMENT COMPANY, L.P.**,  
Houston, TX (US)

(72) Inventors: **Dong Ryul Cha**, Houston, TX (US); **Jq Jung**, Houston, TX (US); **Ilchan Lee**,  
Houston, TX (US)

(73) Assignee: **Hewlett-Packard Development Company, L.P.**, Spring, TX (US)

(\*\*) Term: **15 Years**

(21) Appl. No.: **29/649,852**

(22) Filed: **Jun. 1, 2018**

(51) **LOC (12) Cl.** ..... **14-02**

(52) **U.S. Cl.**  
USPC ..... **D14/327**

(58) **Field of Classification Search**  
USPC ..... D14/315–327, 331, 333–337, 439,  
D14/440–441, 444, 448, 450; D18/1–2,  
D18/7, 11, 12.2–12.3

CPC .... G06F 1/1601; G06F 1/1613; G06F 1/1615;  
G06F 1/1616; G06F 1/1633; G06F  
1/1643; G06F 1/1652; G06F 1/1654;  
G06F 1/1669; G06F 1/1681; G06F  
1/1688; G06F 1/203; H05K 5/0004;  
H05K 5/0017; H05K 5/0021; H05K  
5/0043; H05K 5/0047; H05K 5/0052

See application file for complete search history.

(56) **References Cited**

**U.S. PATENT DOCUMENTS**

D334,739 S \* 4/1993 Tsai ..... D14/326  
D444,462 S \* 7/2001 Tsuji ..... D14/318  
D469,765 S \* 2/2003 Lin ..... D14/322  
D483,357 S \* 12/2003 Wei ..... D14/323  
D538,799 S \* 3/2007 Shi ..... D14/315

D565,563 S \* 4/2008 Kaneshiro ..... D14/315  
D603,396 S \* 11/2009 Latto ..... D14/315  
D613,734 S \* 4/2010 Sun ..... D14/315  
D627,342 S \* 11/2010 Lin ..... D14/315  
D698,349 S \* 1/2014 Sun ..... D14/315  
D734,320 S \* 7/2015 Wu ..... D14/315  
D797,718 S \* 9/2017 Chu ..... D14/315  
D804,467 S \* 12/2017 Probst ..... D14/315  
D804,468 S \* 12/2017 Armstrong ..... D14/315  
D823,849 S \* 7/2018 Lim ..... D14/318

(Continued)

**OTHER PUBLICATIONS**

Colaner, Seth, CyberPowerPC Fangbook X7-200 Gaming Notebook, posted at HotHardware, posting date Apr. 4, 2013. Site visited May 24, 2019. URL: <<https://hothardware.com/reviews/cyberpowerpc-fangbook-x7200-review>> (Year: 2013).\*

(Continued)

*Primary Examiner* — Kevin K Rudzinski

*Assistant Examiner* — Kathleen L Jones

(74) *Attorney, Agent, or Firm* — HPI Patent Department

(57) **CLAIM**

We claim the ornamental design for a computer, as shown and described.

**DESCRIPTION**

FIG. 1 is a front perspective view of the claimed design;

FIG. 2 is a top plan view thereof;

FIG. 3 is a bottom plan view thereof;

FIG. 4 is a right side elevational view thereof;

FIG. 5 is a left side elevational view thereof;

FIG. 6 is a front elevational view thereof; and,

FIG. 7 is a rear elevational view thereof.

The broken lines in the drawings are directed to environmental structure and are for illustrative purposes only. Accordingly, the broken lines form no part of the claimed design.

**1 Claim, 5 Drawing Sheets**

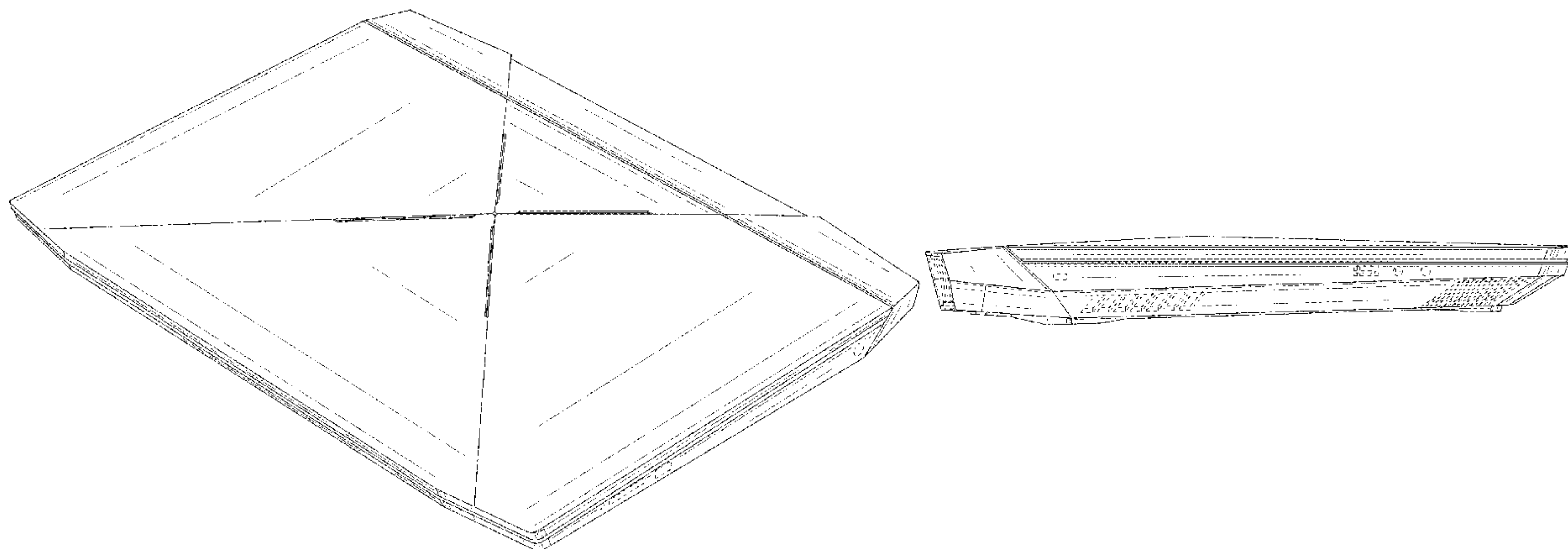

(56)

**References Cited**

U.S. PATENT DOCUMENTS

D825,554 S \* 8/2018 Nagai ..... D14/315  
D832,837 S \* 11/2018 Pennington, Jr. .... D14/348  
D836,642 S \* 12/2018 Hong ..... D14/440  
2003/0053287 A1\* 3/2003 Baldwin ..... G06F 1/1616  
361/679.09

OTHER PUBLICATIONS

Cerejo, Roydon, HP Omen X Gaming Laptop Review, posted at NDTV Gadgets360, posting date Jul. 13, 2018. Site visited Jun. 5, 2019. URL:<<https://gadgets.ndtv.com/laptops/reviews/hp-omen-x-gaming-laptop-hp-17-ap047tx-review-1876895>> (Year: 2018).\*

\* cited by examiner

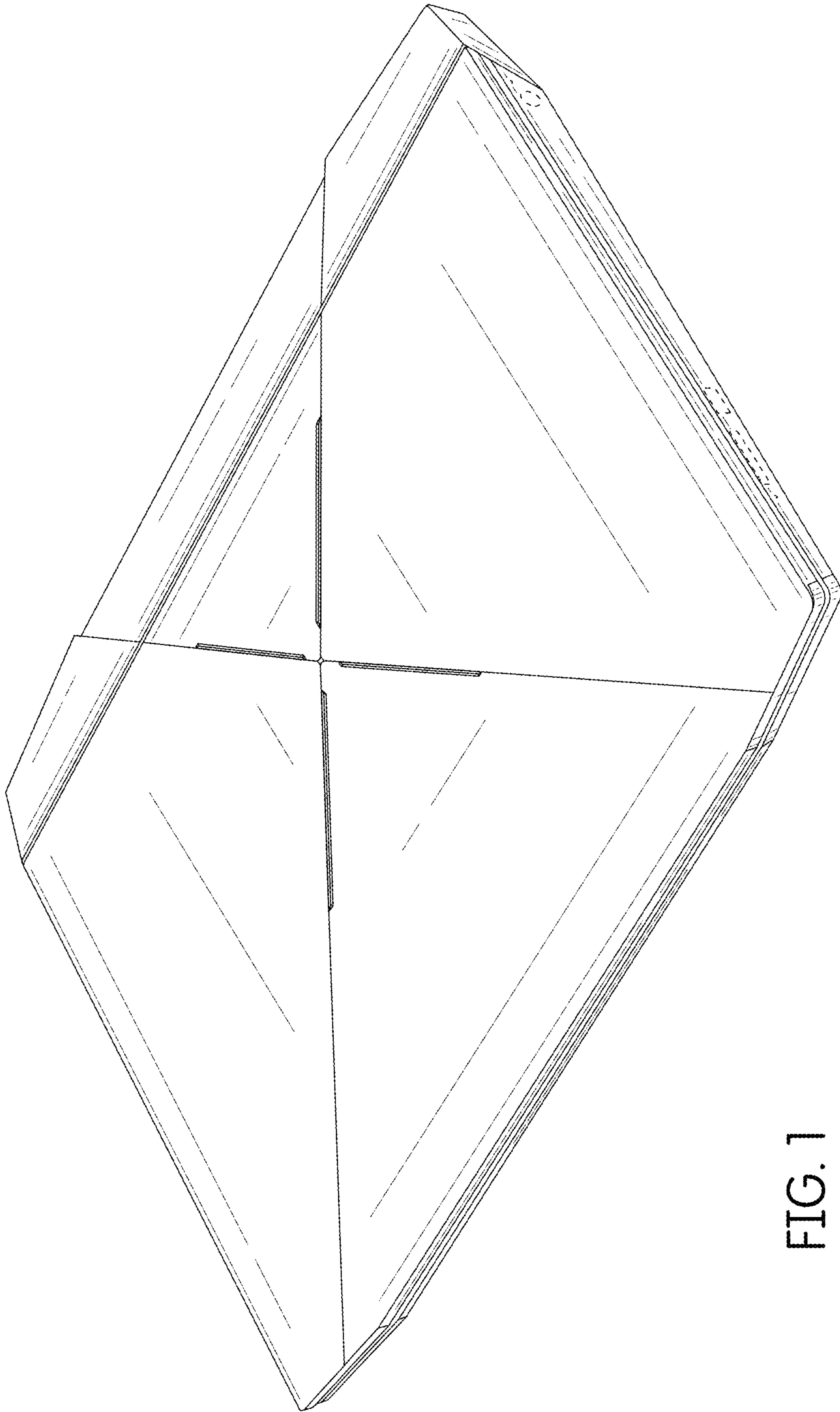

FIG. 1

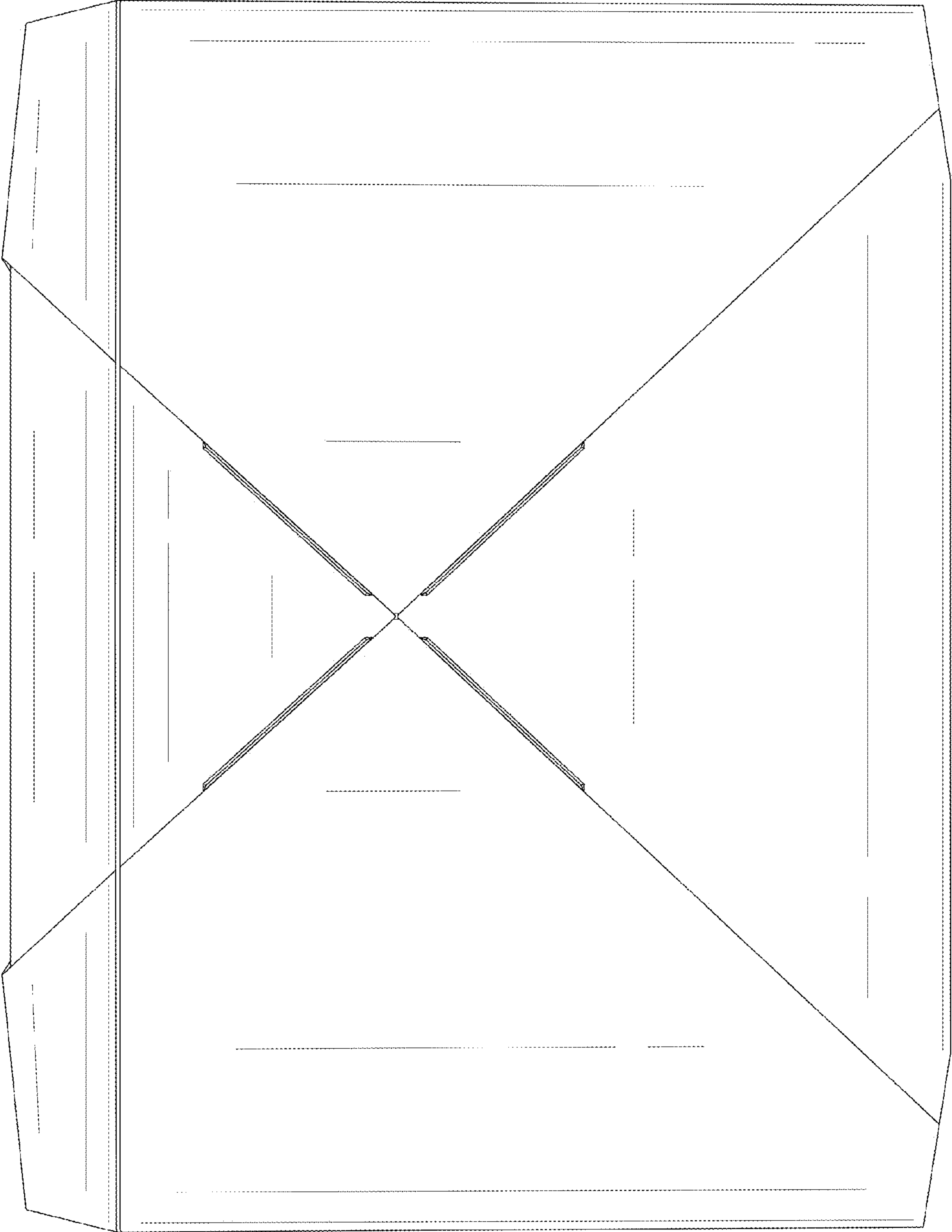

FIG. 2



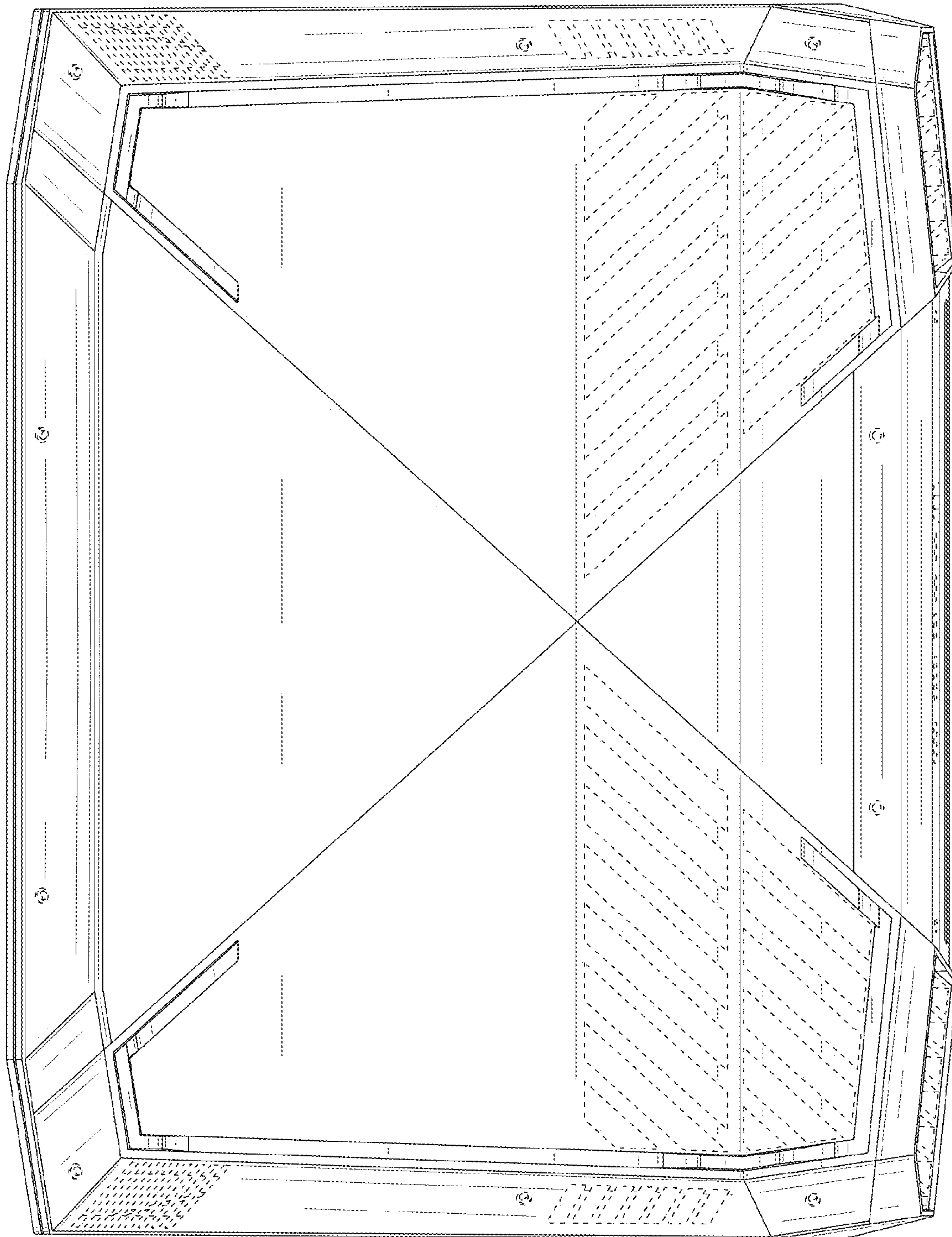

FIG. 3

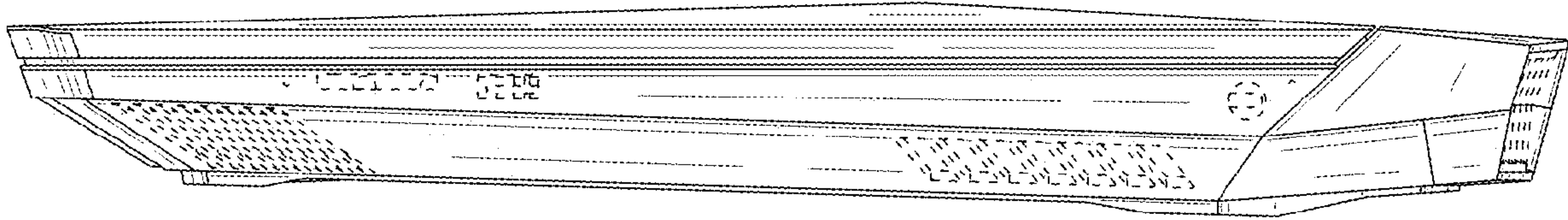

FIG. 4

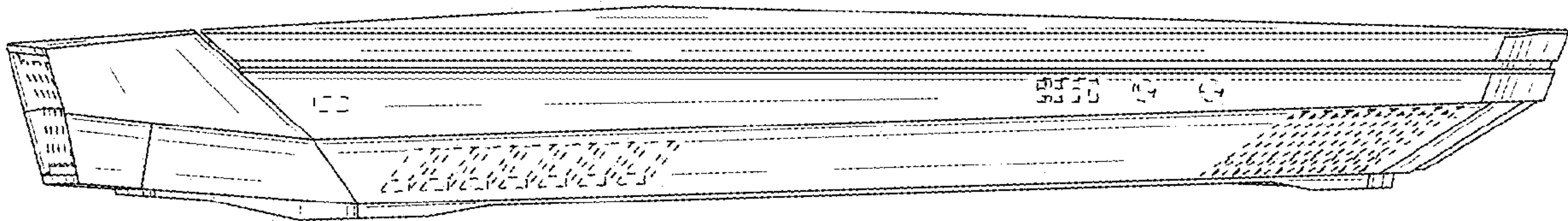

FIG. 5

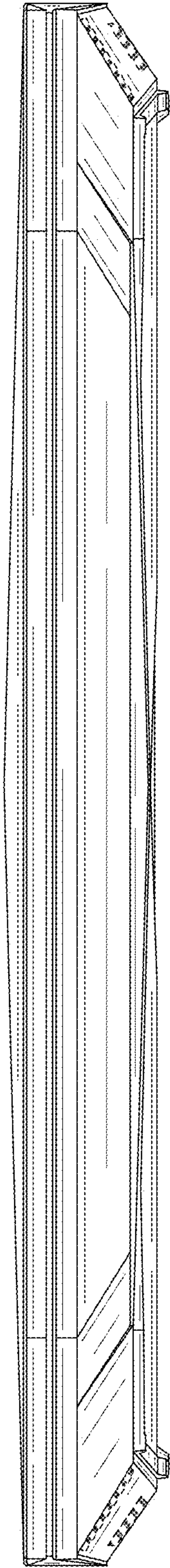

FIG. 6

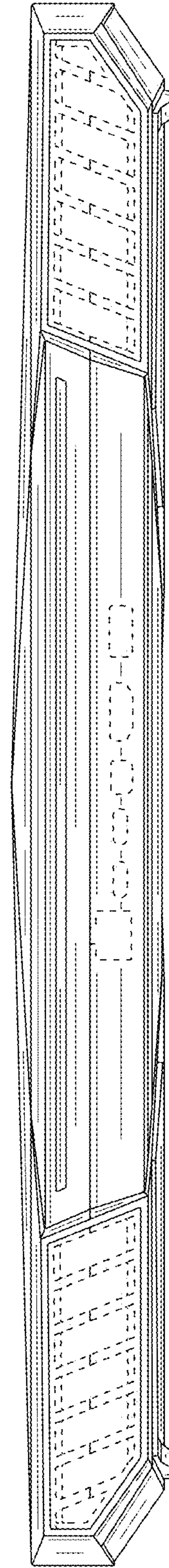

FIG. 7