



US00D877578S

(12) **United States Design Patent**  
**Ireland**

(10) **Patent No.:** **US D877,578 S**  
(45) **Date of Patent:** **\*\* Mar. 10, 2020**

(54) **AGRICULTURAL STAKE**

**DESCRIPTION**

- (71) Applicant: **FLORIDA AGRICULTURAL STAKES, LLC**, Oakland, FL (US)
- (72) Inventor: **Kenneth D. Ireland**, Oakland, FL (US)
- (73) Assignee: **FLORIDA AGRICULTURAL STAKES, LLC**, Oakland, FL (US)
- (\*\*) Term: **15 Years**
- (21) Appl. No.: **29/658,726**
- (22) Filed: **Aug. 2, 2018**
- (51) **LOC (12) Cl.** ..... **08-01**
- (52) **U.S. Cl.**  
USPC ..... **D8/1**
- (58) **Field of Classification Search**  
USPC .... D8/1, 391; D25/122, 132, 131, 126, 135, D25/127; D26/138; D21/840; D22/120  
(Continued)

FIG. 1 is a top perspective view of a first embodiment of an agricultural stake;  
 FIG. 2 is a right side view of the first embodiment of the agricultural stake;  
 FIG. 3 is a left side view of the first embodiment of the agricultural stake;  
 FIG. 4 is a top view of the first embodiment of the agricultural stake;  
 FIG. 5 is a bottom view of the first embodiment of the agricultural stake;  
 FIG. 6 is a cross sectional view of the first embodiment of the agricultural stake taken in the direction of line 6-6 of FIG. 2;  
 FIG. 7 is a top perspective view of a second embodiment of an agricultural stake;  
 FIG. 8 is a right side view of the second embodiment of the agricultural stake;  
 FIG. 9 is a left side view of the second embodiment of the agricultural stake;  
 FIG. 10 is a top view of the second embodiment of the agricultural stake;  
 FIG. 11 is a bottom view of the second embodiment of the agricultural stake;  
 FIG. 12 is a cross sectional view of the second embodiment of the agricultural stake taken in the direction of line 12-12 of FIG. 8;  
 FIG. 13 is a top perspective view of a third embodiment of an agricultural stake;  
 FIG. 14 is a right side view of the third embodiment of the agricultural stake;  
 FIG. 15 is a left side view of the third embodiment of the agricultural stake;  
 FIG. 16 is a top view of the third embodiment of the agricultural stake;  
 FIG. 17 is a bottom view of the third embodiment of the agricultural stake;  
 FIG. 18 is a cross sectional view of the third embodiment of the agricultural stake taken in the direction of line 18-18 of FIG. 14;  
 FIG. 19 is a top perspective view of a fourth embodiment of an agricultural stake;

(56) **References Cited**

**U.S. PATENT DOCUMENTS**

- 3,448,585 A \* 6/1969 Vogelsang ..... E02D 5/60  
405/216
- D223,237 S \* 4/1972 Watanabe et al. .... D25/126  
(Continued)

**OTHER PUBLICATIONS**

Fiberglass Stakes, Fiberglass Stakes Suppliers and Manufacturers at alibaba.com; Website; 1999-2018 Alibaba.com; 7 pages; available at [https://www.alibaba.com/showroom/fiberglass-stakes\\_1.html](https://www.alibaba.com/showroom/fiberglass-stakes_1.html).

*Primary Examiner* — Sheryl Lane

(74) *Attorney, Agent, or Firm* — Matthew G. McKinney, Esq.; Allen, Dyer et al.

(57) **CLAIM**

The ornamental design for an agricultural stake, as shown and described.

(Continued)

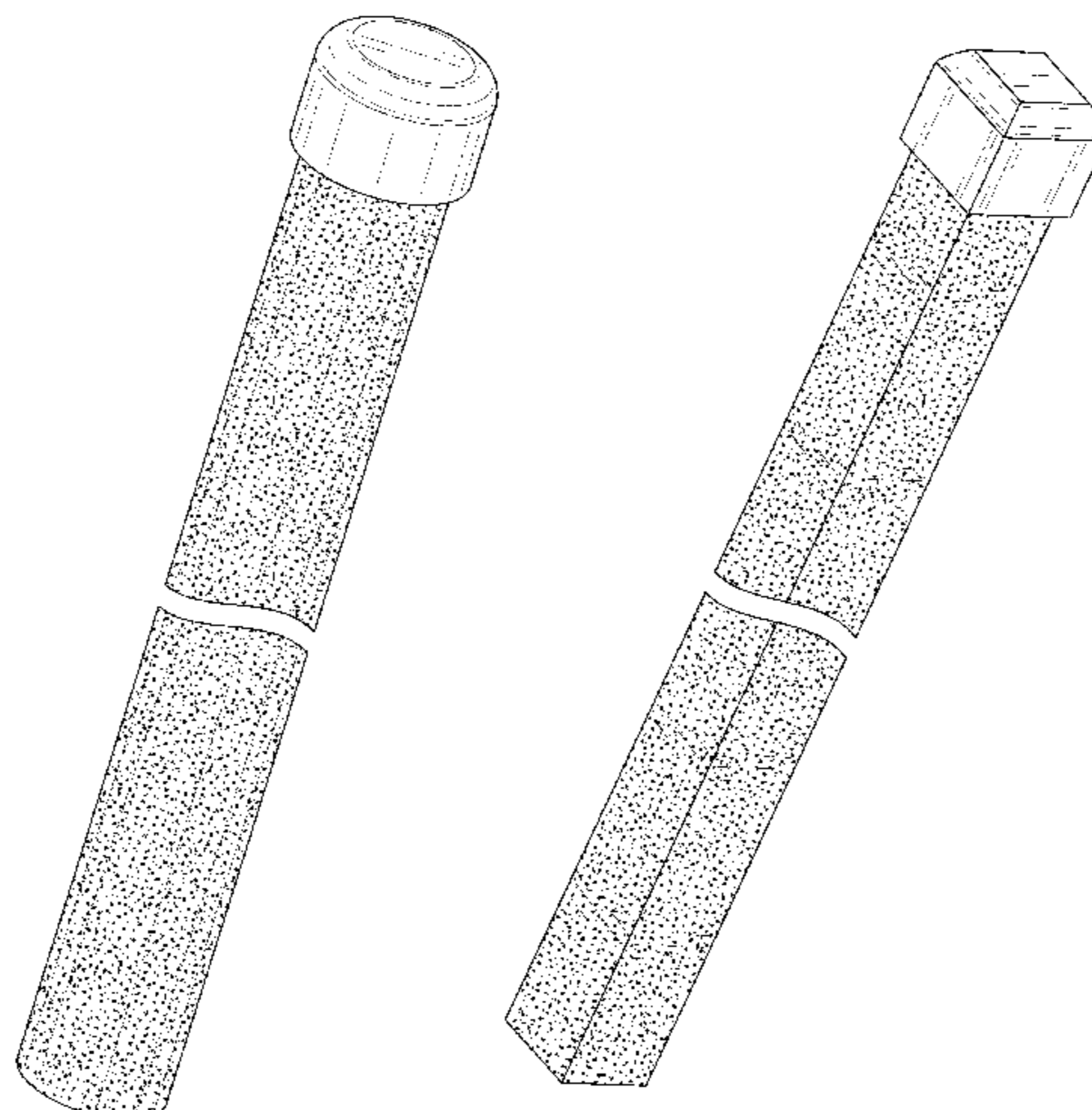

FIG. 20 is a right side view of the fourth embodiment of the agricultural stake;  
 FIG. 21 is a left side view of the fourth embodiment of the agricultural stake;  
 FIG. 22 is a top view of the fourth embodiment of the agricultural stake;  
 FIG. 23 is a bottom view of the fourth embodiment of the agricultural stake;  
 FIG. 24 is a cross sectional view of the fourth embodiment of the agricultural stake taken in the direction of line 24-24 of FIG. 20;  
 FIG. 25 is a top perspective view of a fifth embodiment of an agricultural stake;  
 FIG. 26 is a right side view of the fifth embodiment of the agricultural stake;  
 FIG. 27 is a left side view of the fifth embodiment of the agricultural stake;  
 FIG. 28 is a top view of the fifth embodiment of the agricultural stake;  
 FIG. 29 is a bottom view of the fifth embodiment of the agricultural stake; and,  
 FIG. 30 is a cross sectional view of the fifth embodiment of the agricultural stake taken in the direction of line 30-30 of FIG. 26.  
 The broken lines represent portions of the article and form no part of the claimed design.

**1 Claim, 15 Drawing Sheets**

(58) **Field of Classification Search**  
 CPC .... A01G 17/14; A01G 17/06; A01G 13/0225;  
 A01G 9/122; A01G 9/124; E04H 17/12  
 See application file for complete search history.

(56)

**References Cited**

U.S. PATENT DOCUMENTS

D229,538	S	*	12/1973	Steffan	.....	D8/397
3,875,699	A		4/1975	Lamarre		
D253,223	S	*	10/1979	Manning, Jr.	.....	D8/1
4,373,833	A		2/1983	Watanabe		
4,745,706	A	*	5/1988	Muza	.....	A01G 29/00 47/47
4,803,802	A	*	2/1989	Strumbos	.....	A01G 9/122 47/47
5,279,073	A		1/1994	Czebieniak		
D394,271	S	*	5/1998	Croghan	.....	D15/136
D482,128	S	*	11/2003	Krueger	.....	D25/126
D507,618	S	*	7/2005	Scarpa, III	.....	D21/799.1
D524,611	S	*	7/2006	Liu	.....	D23/209
D525,721	S	*	7/2006	Landes	.....	D25/126
D527,439	S	*	8/2006	Liu	.....	D23/209
D547,464	S	*	7/2007	Petta	.....	D25/135
D582,573	S	*	12/2008	Fears	.....	D25/135
D645,114	S	*	9/2011	Krause	.....	D22/120
8,082,702	B2	*	12/2011	Hill	.....	E02D 5/80 52/155
D654,384	S	*	2/2012	McDonald	.....	D10/66
8,322,678	B2	*	12/2012	Zhu	.....	E04H 12/2215 248/156
D697,164	S	*	1/2014	Jan	.....	D22/120
D703,011	S	*	4/2014	Tscharner	.....	D8/1
D711,698	S	*	8/2014	Tscharner	.....	D8/1
9,309,673	B1	*	4/2016	Tscharner	.....	E04G 21/3252
D768,809	S	*	10/2016	Krotz	.....	D23/200
D852,313	S	*	6/2019	Luo	.....	D22/120
D854,386	S	*	7/2019	Bottari	.....	A01G 13/0237 D8/1
2007/0101674	A1	*	5/2007	Stinson	.....	B29C 53/066 52/843
2015/0059242	A1	*	3/2015	Montagano	.....	A01G 17/04 47/44
2016/0135386	A1	*	5/2016	Merz	.....	A01G 9/124 47/70
2016/0230412	A1	*	8/2016	Keenan	.....	E04H 17/00

\* cited by examiner

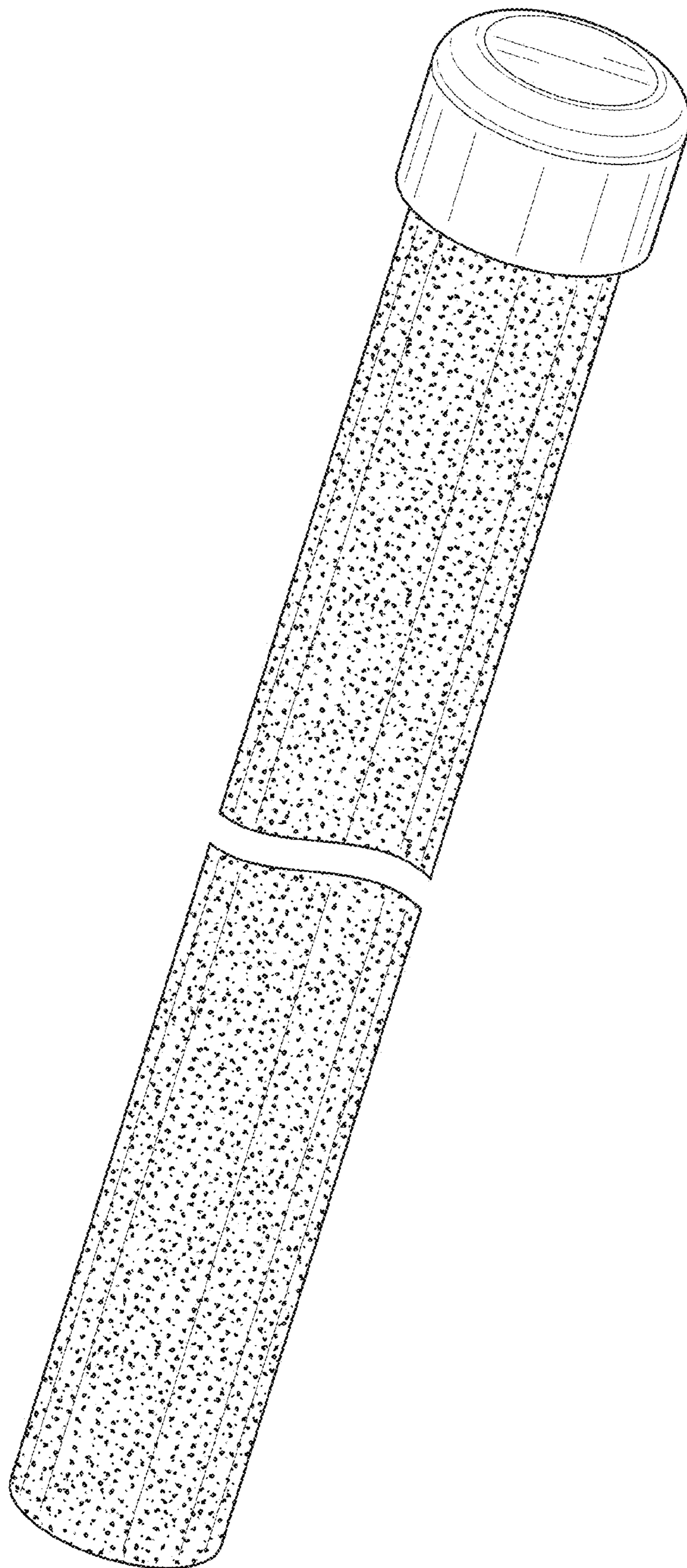

FIG. 1

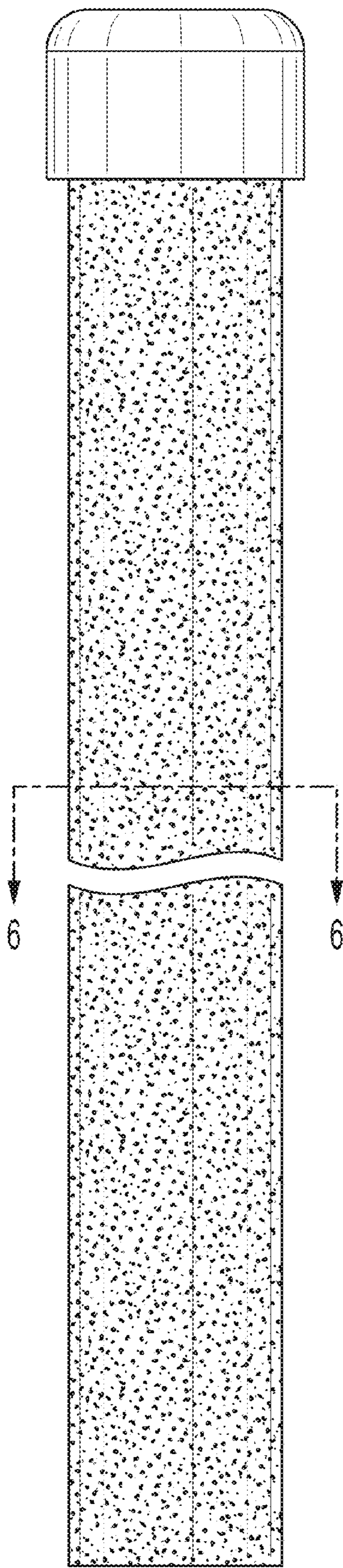

FIG. 2

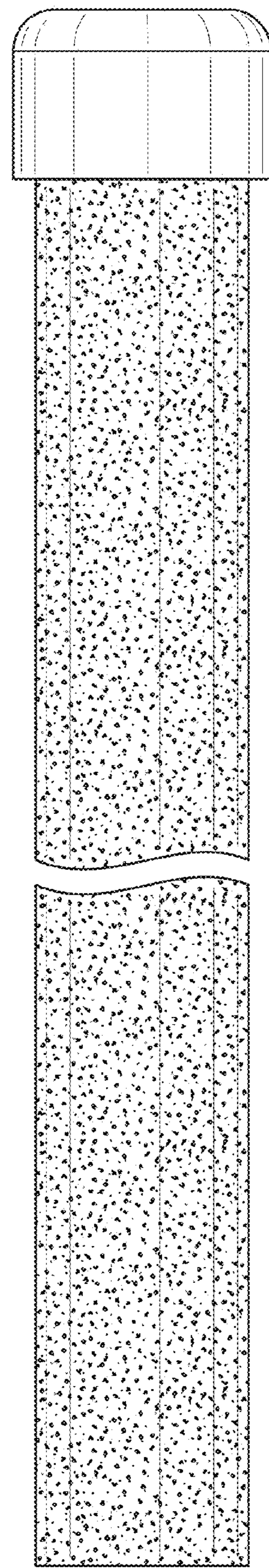

FIG. 3

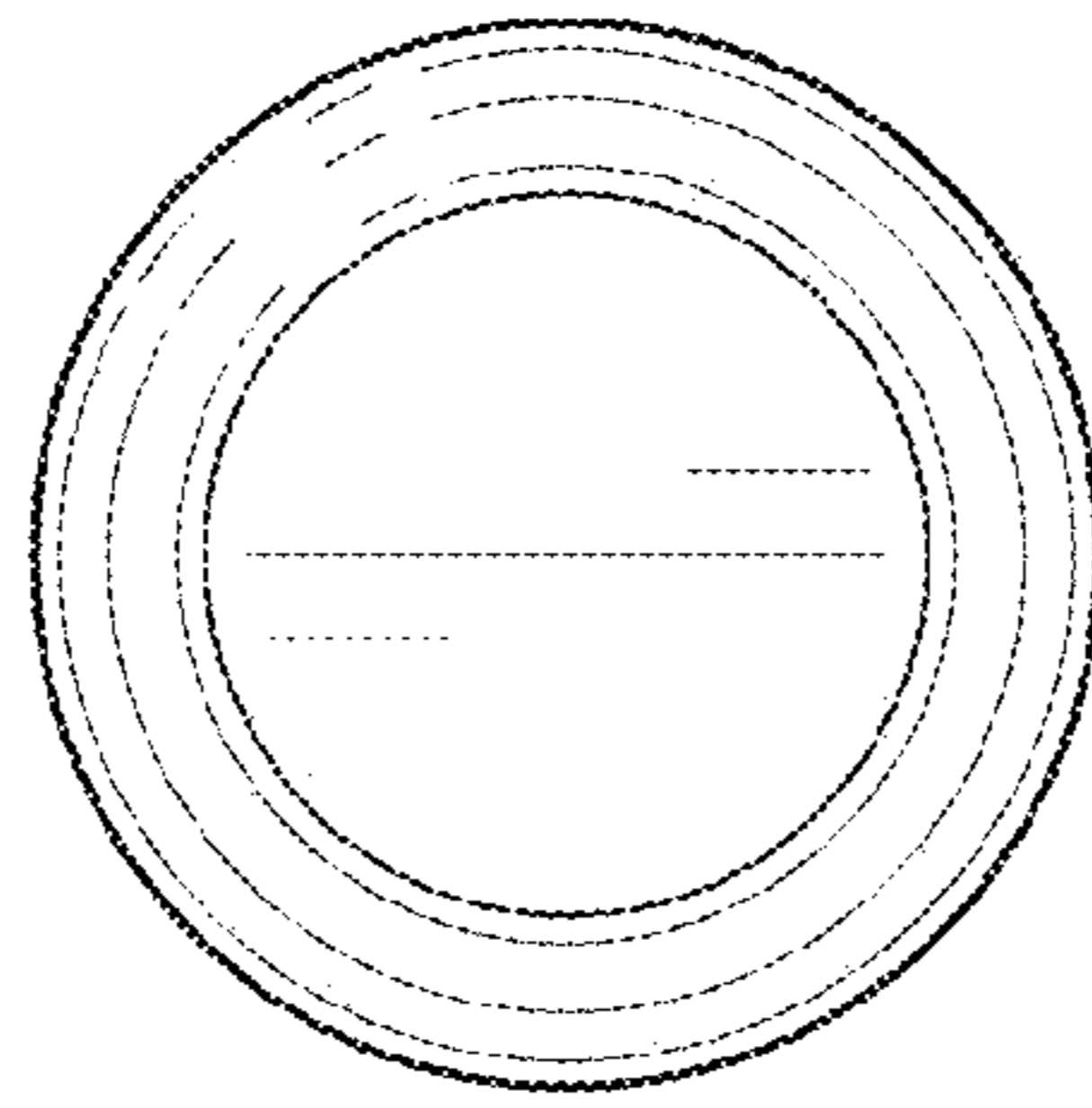

FIG. 4

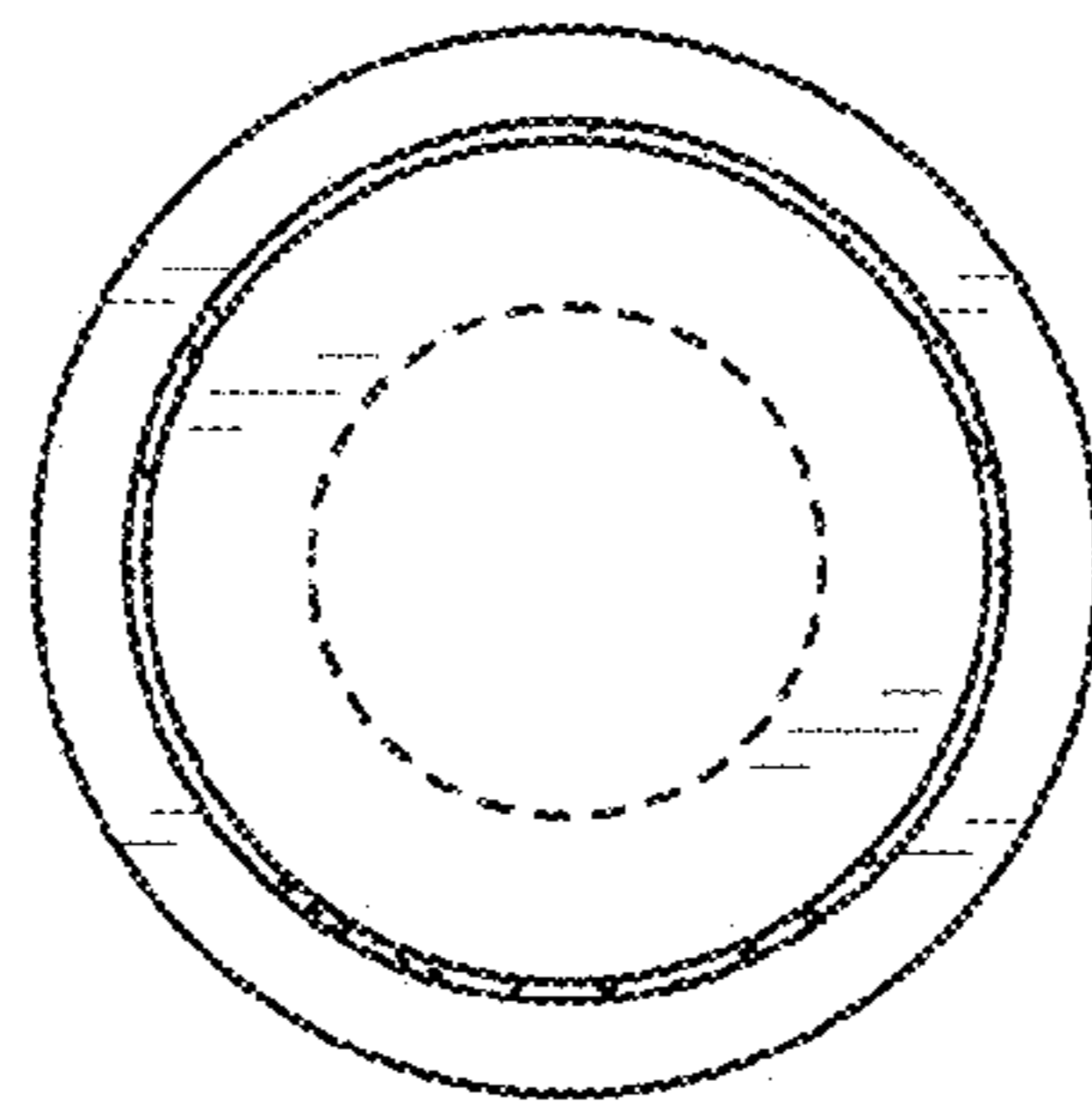

FIG. 5

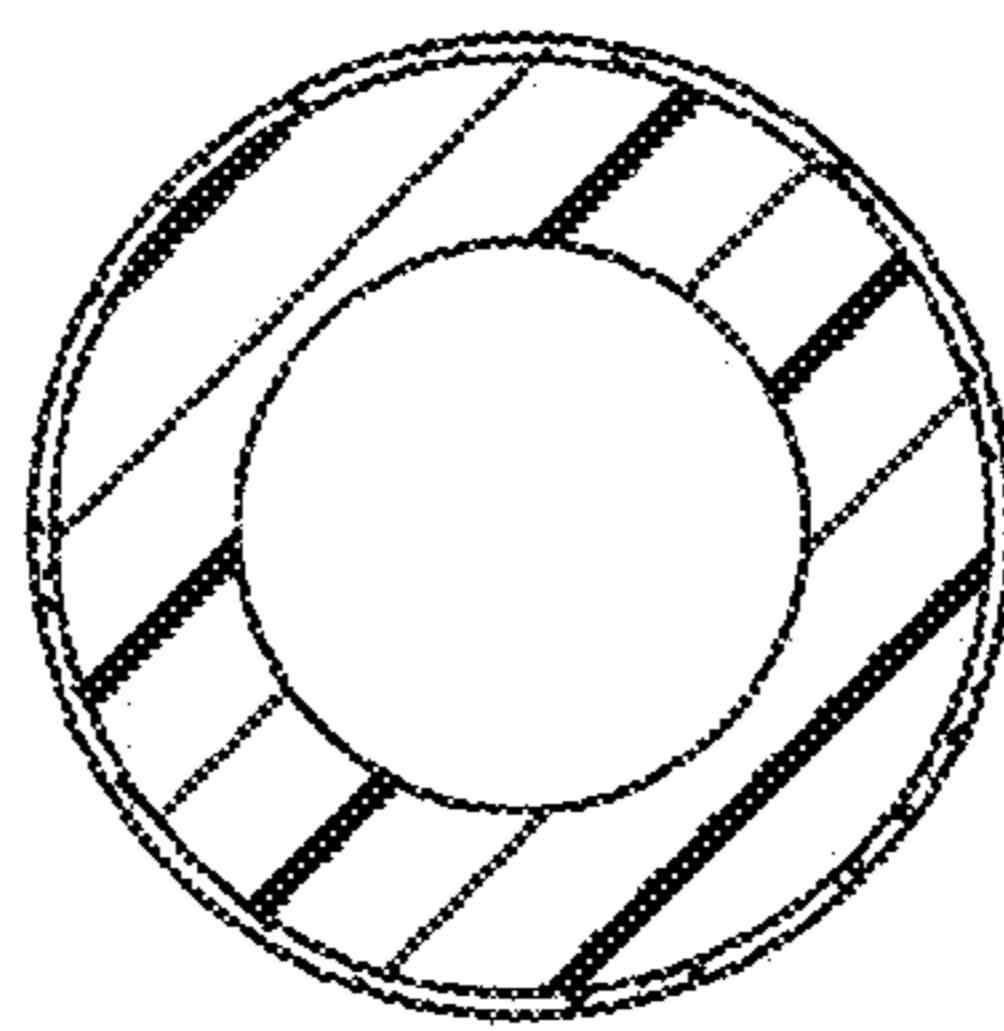

FIG. 6

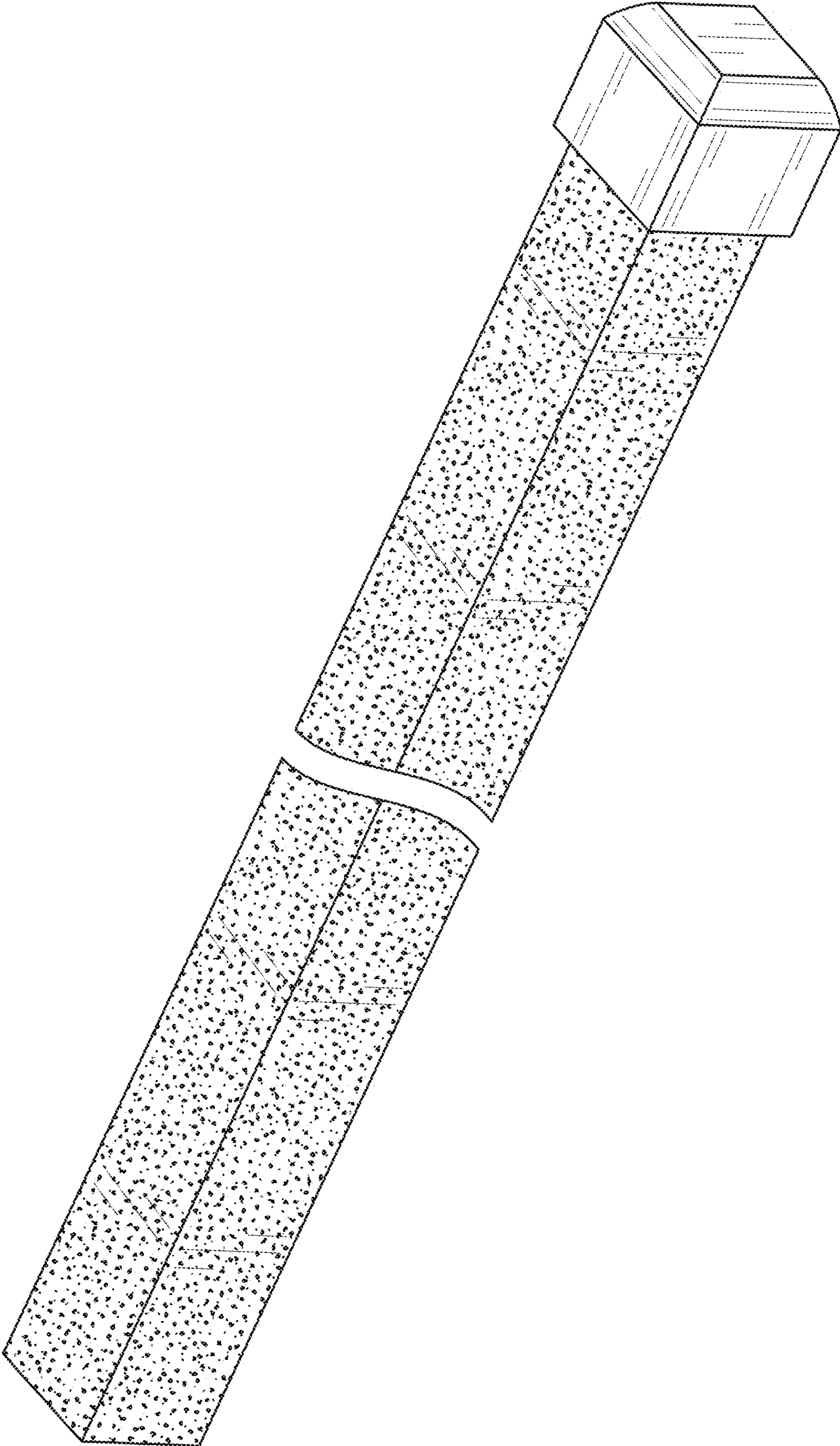

FIG. 7

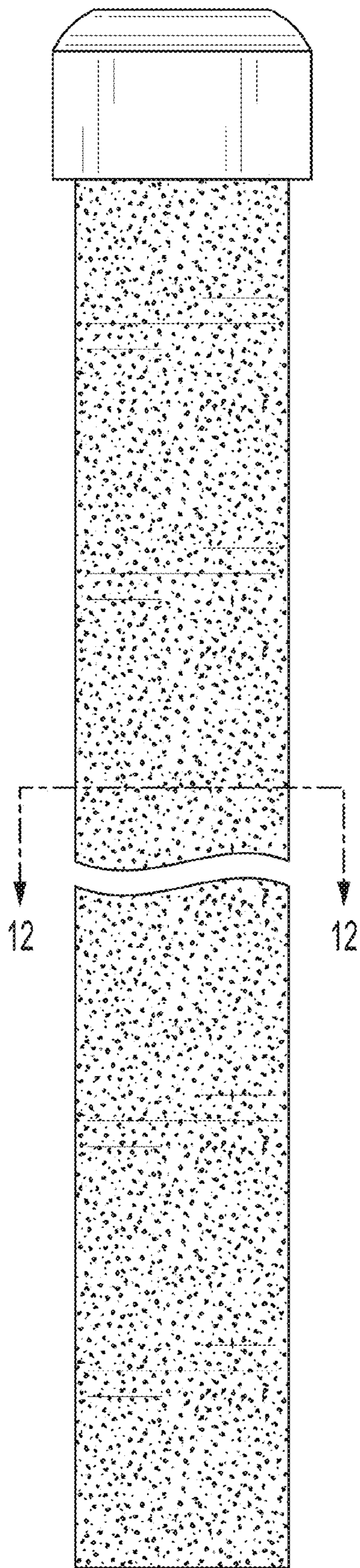

FIG. 8

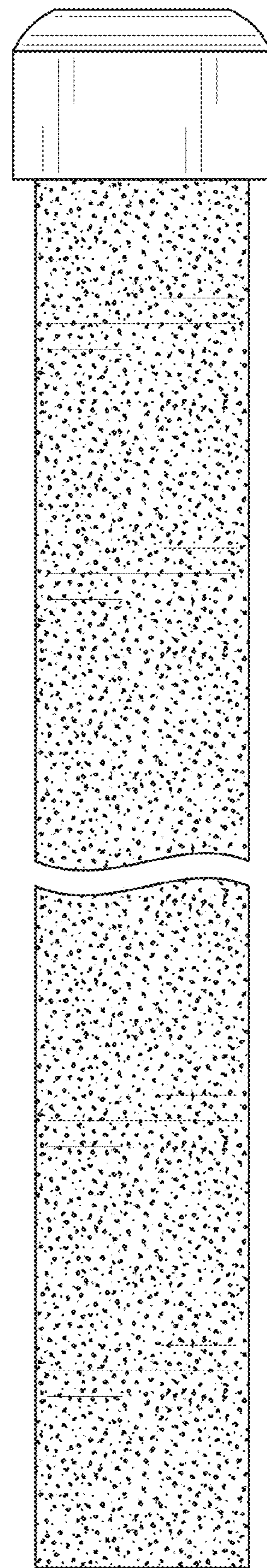

FIG. 9

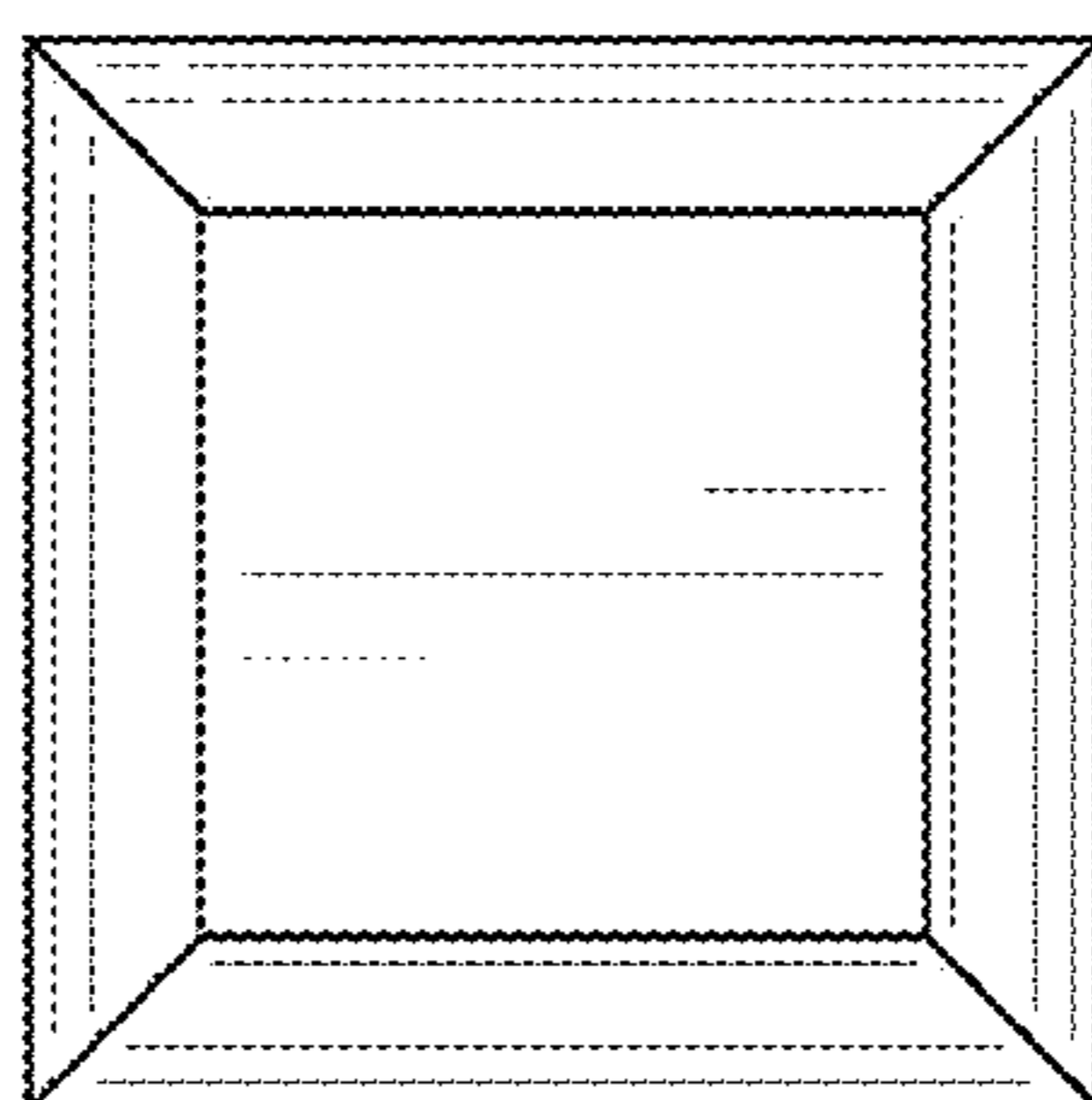

FIG. 10

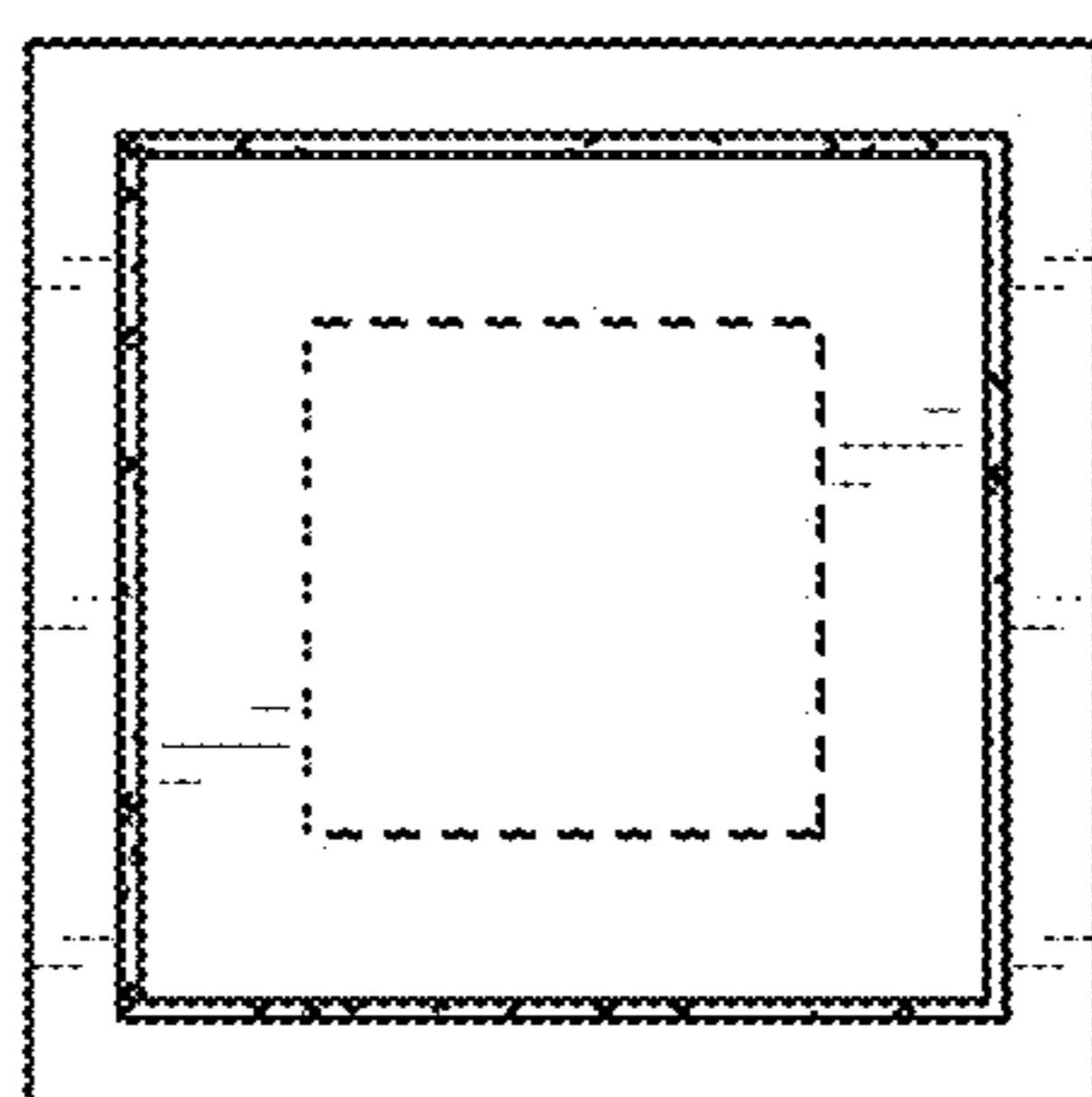

FIG. 11

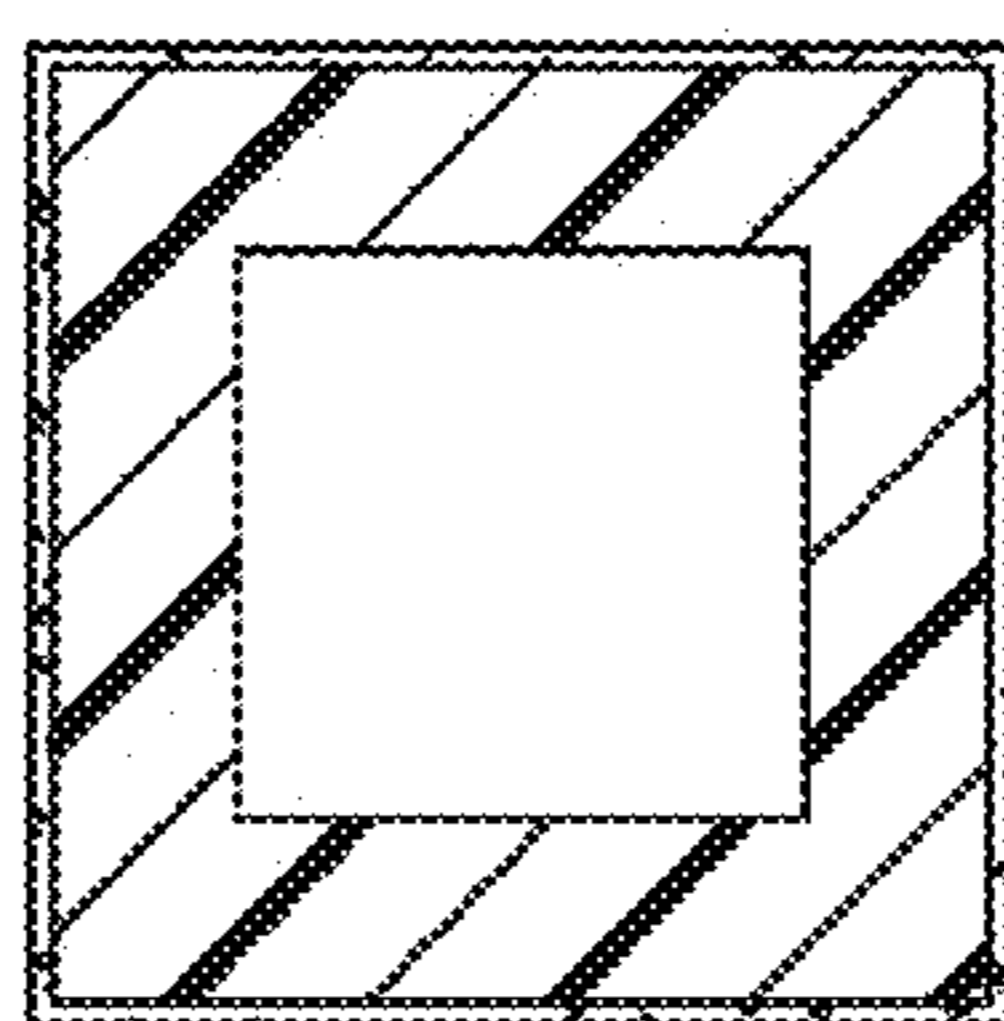

FIG. 12



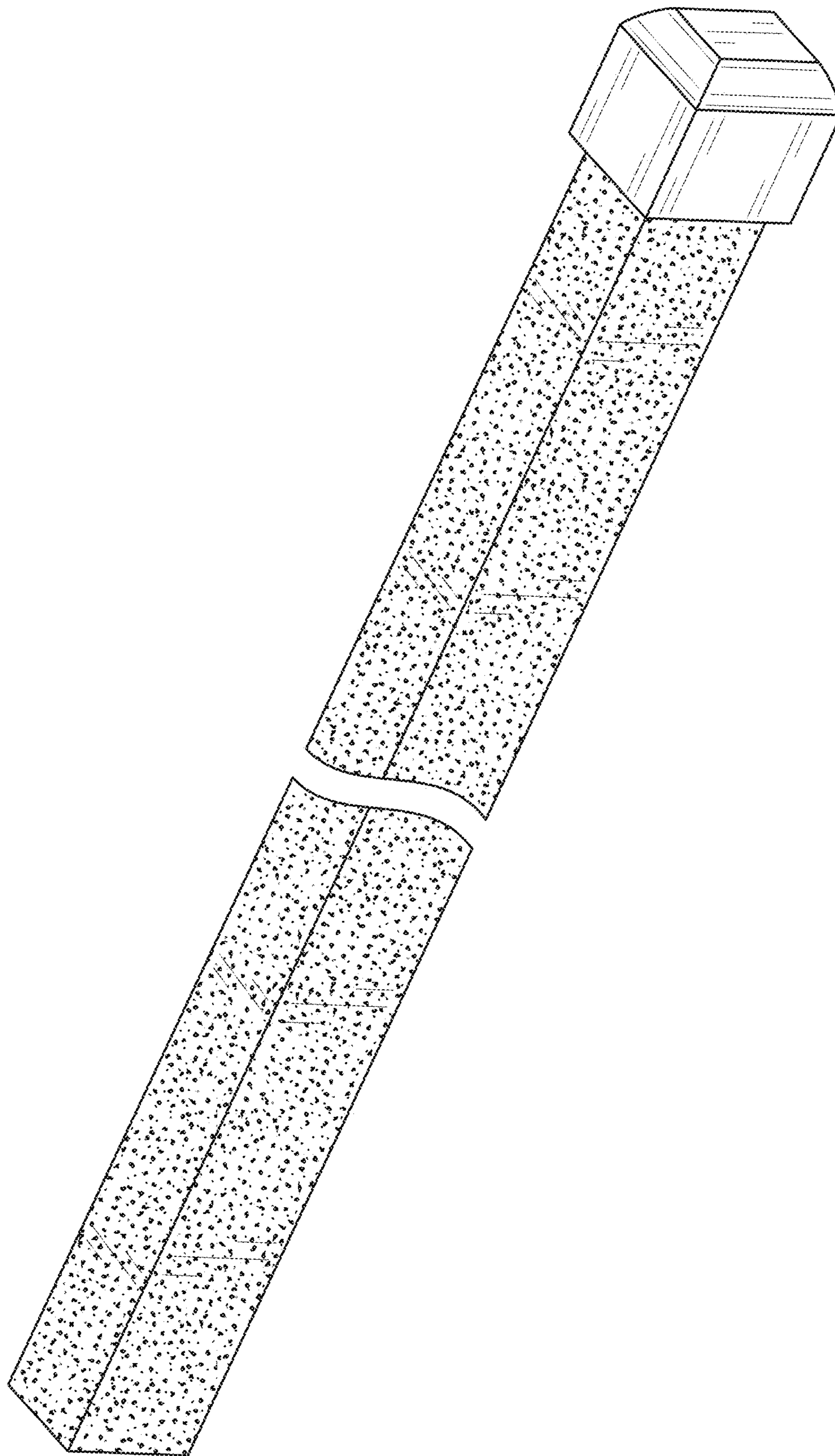

FIG. 13

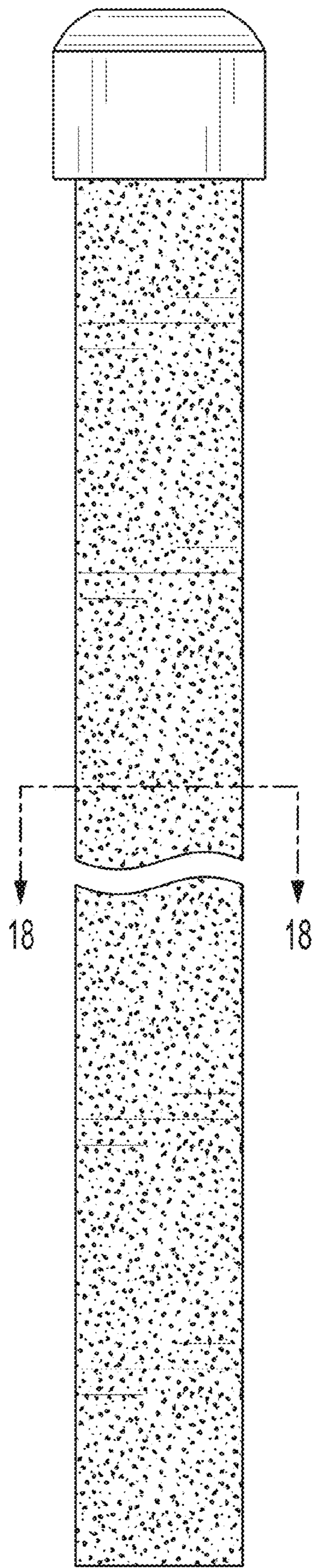

FIG. 14

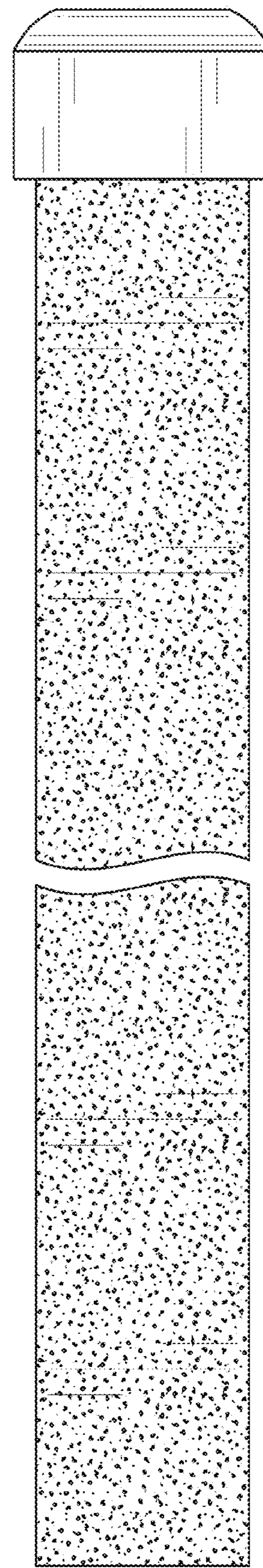

FIG. 15

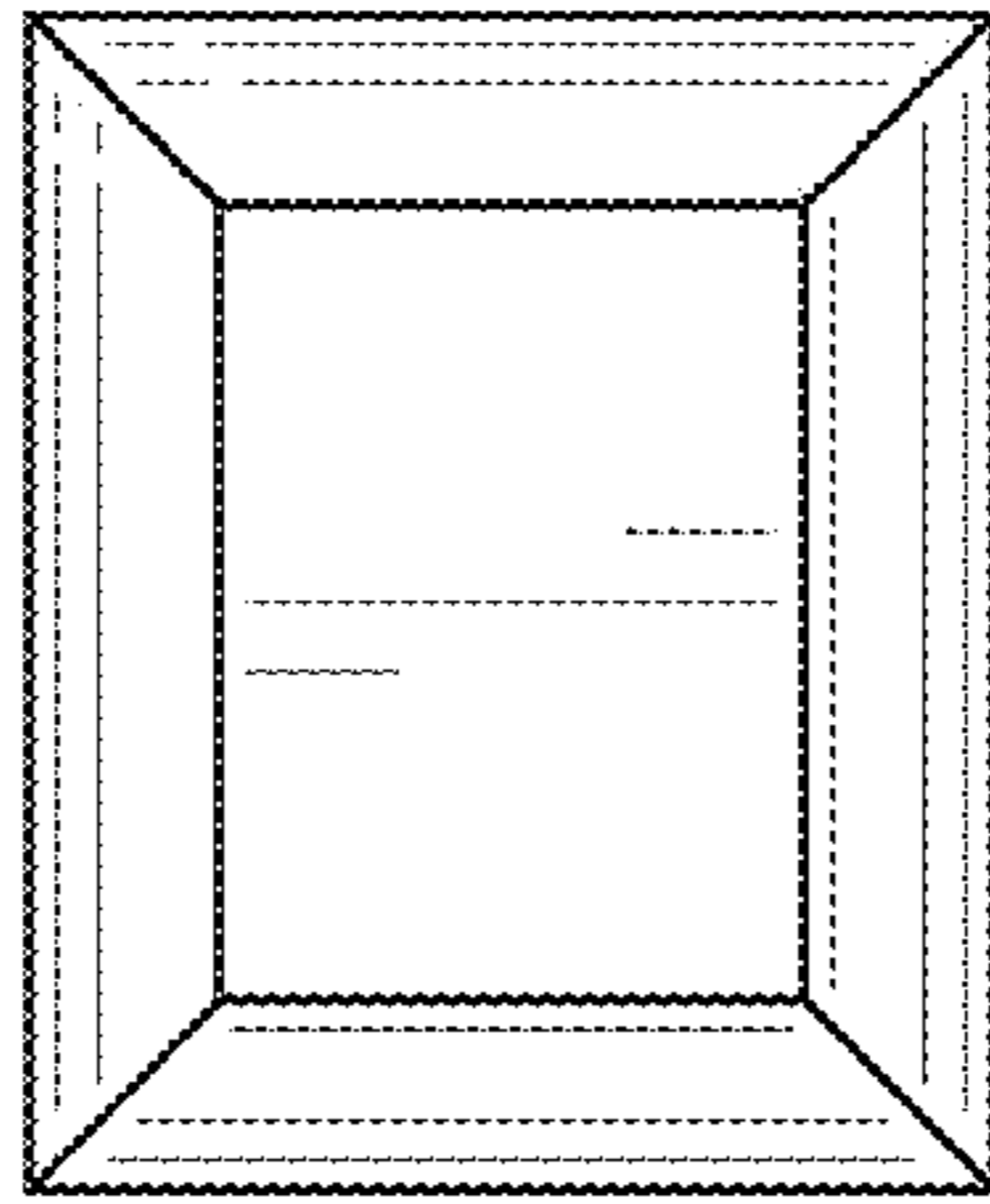

FIG. 16

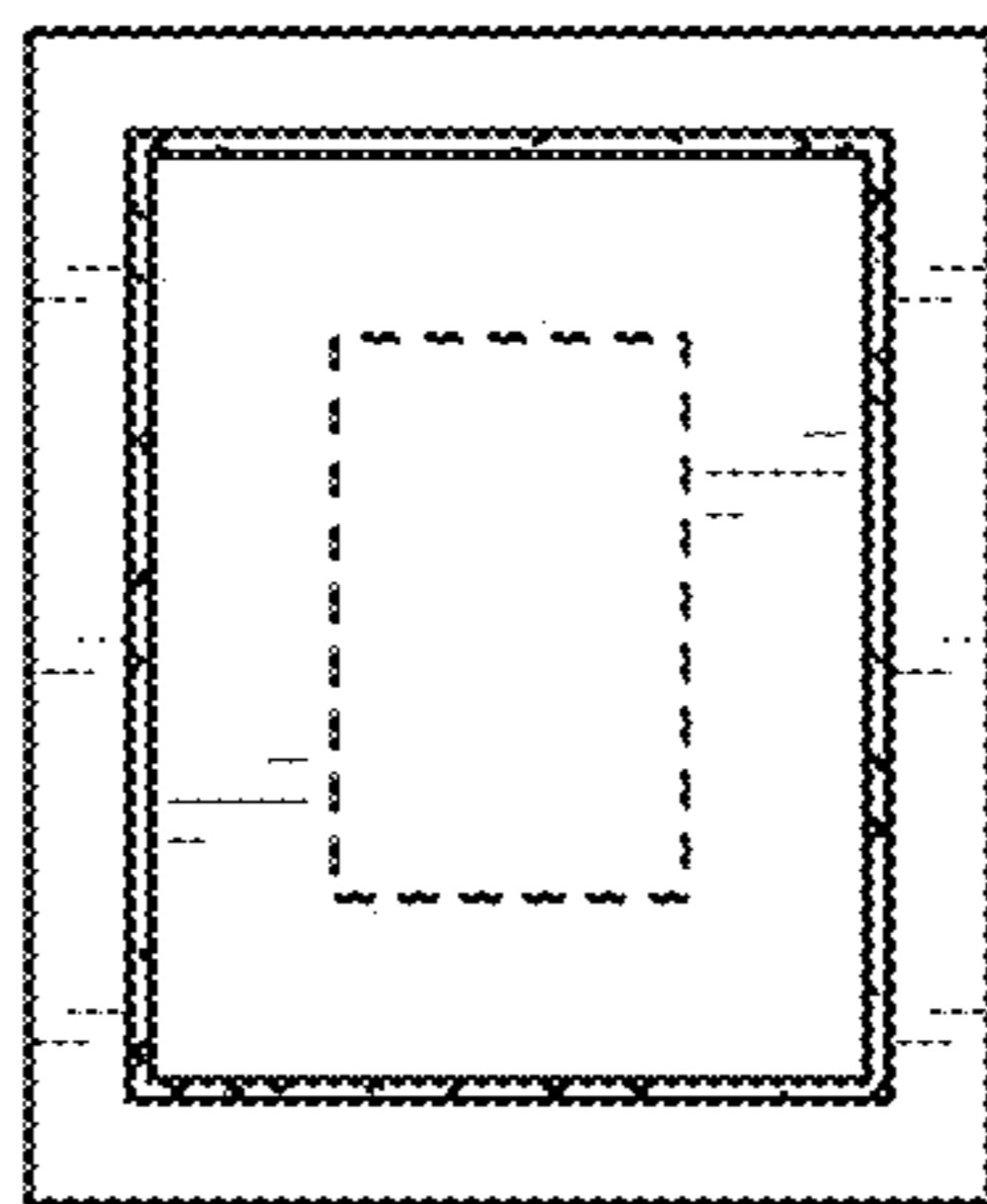

FIG. 17

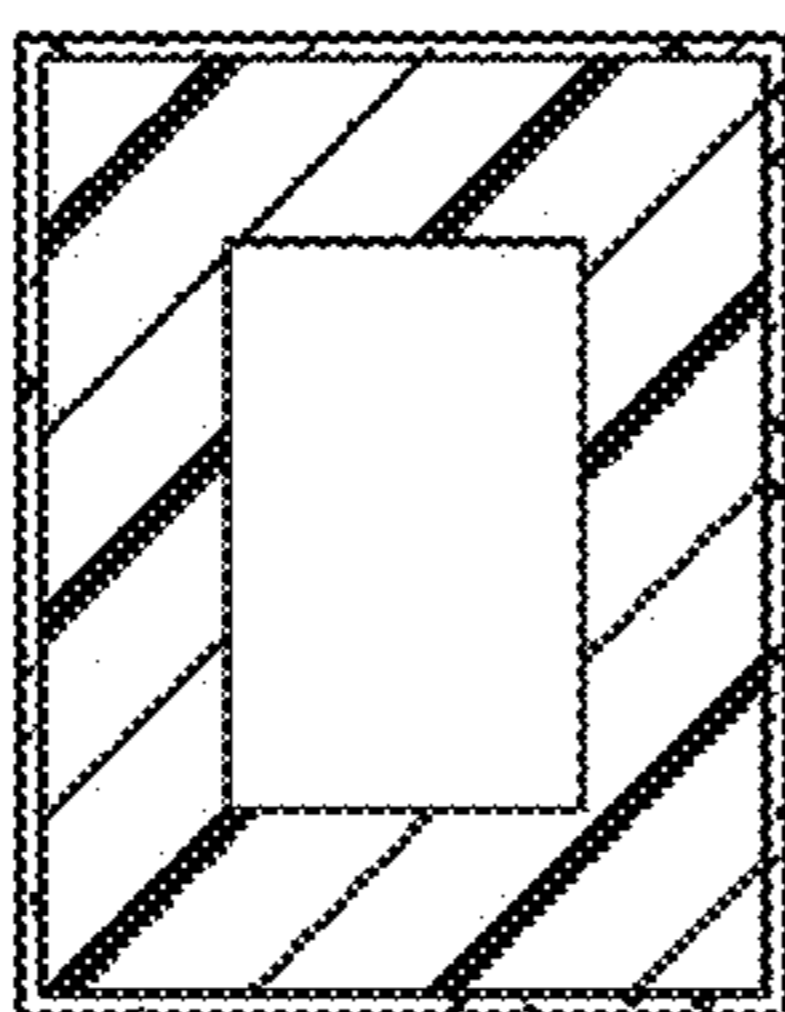

FIG. 18

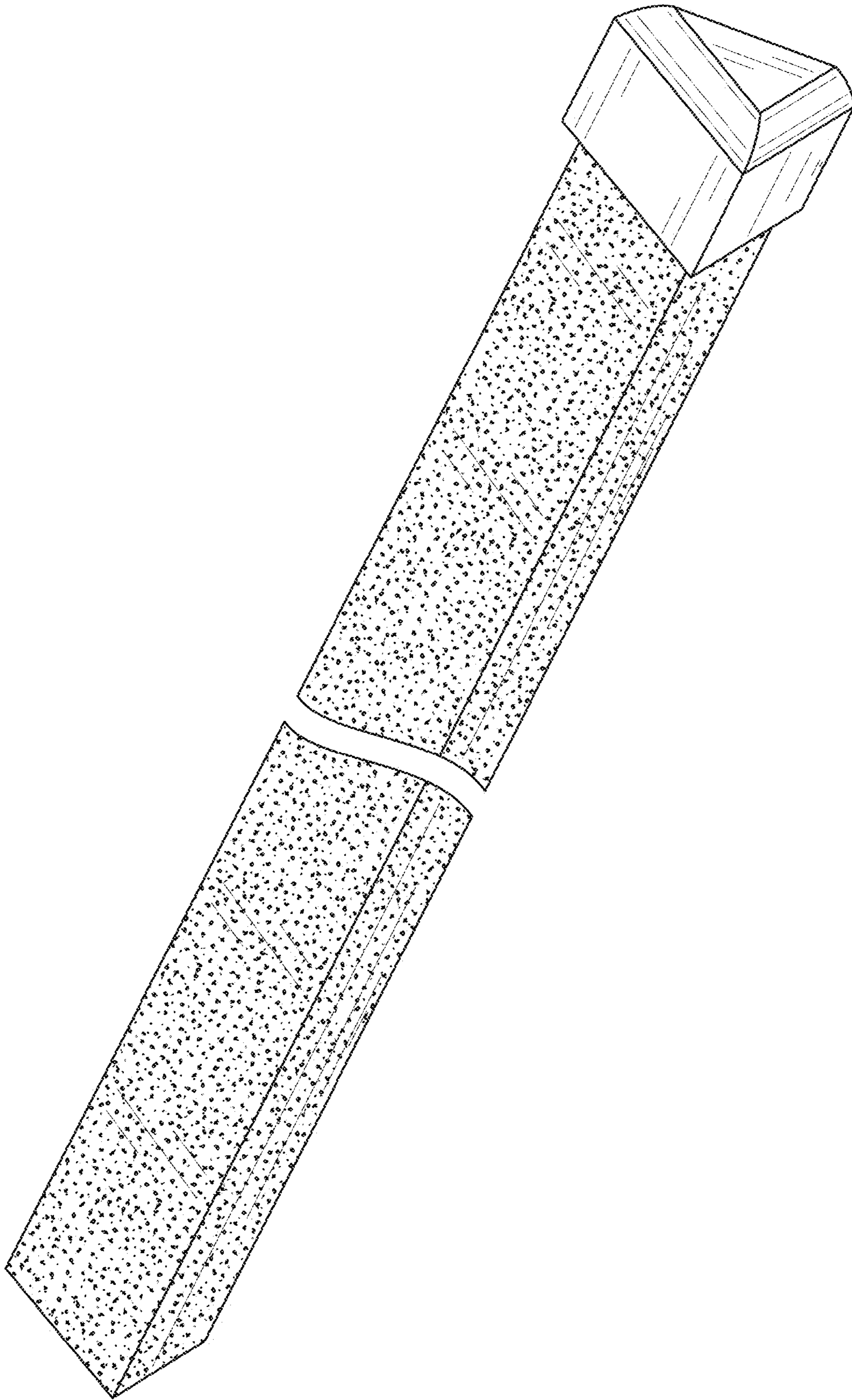

FIG. 19

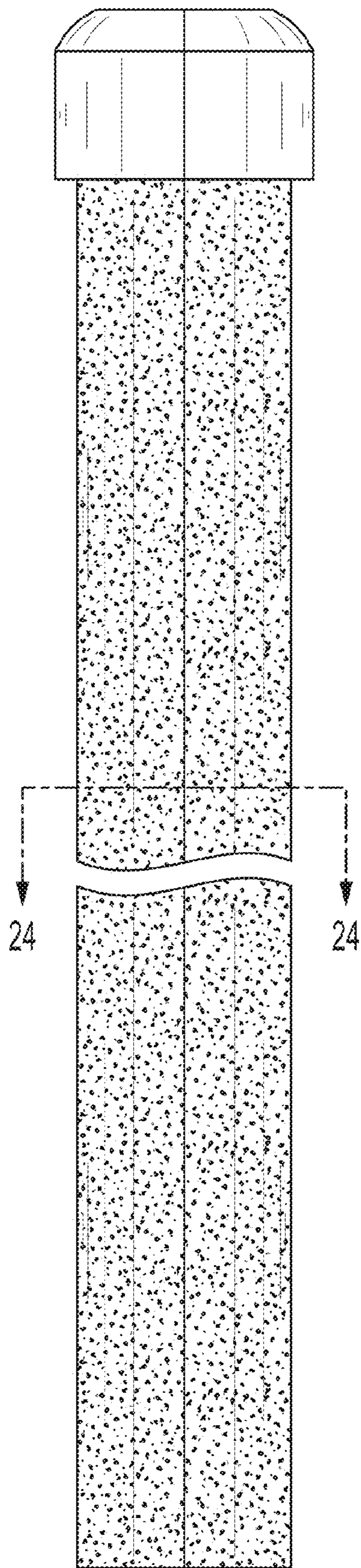

FIG. 20

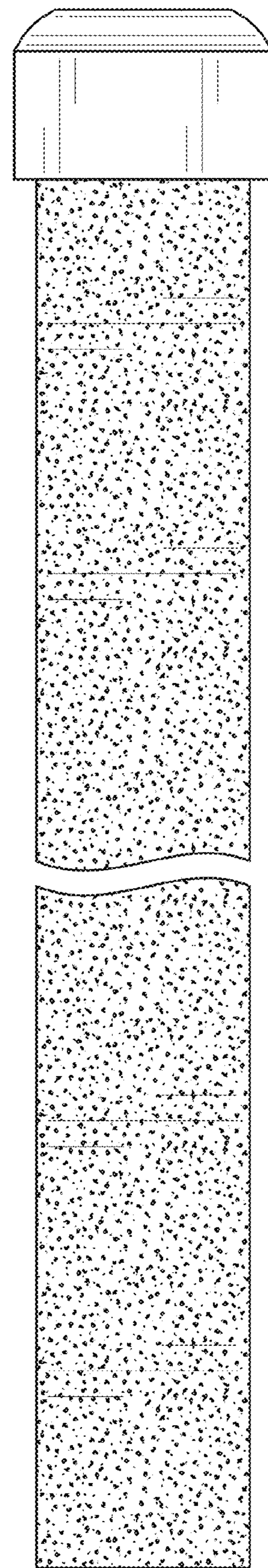

FIG. 21

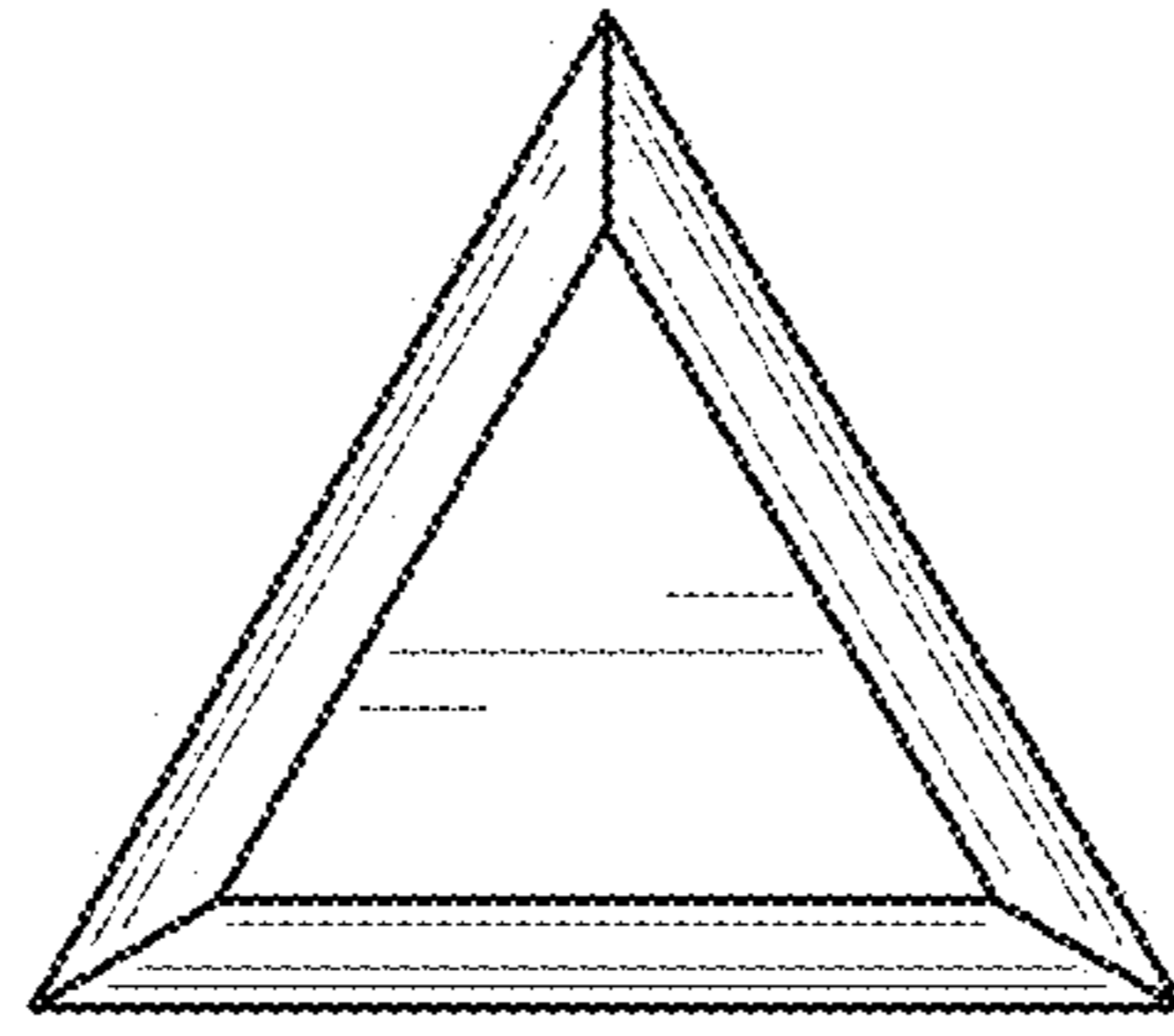

FIG. 22

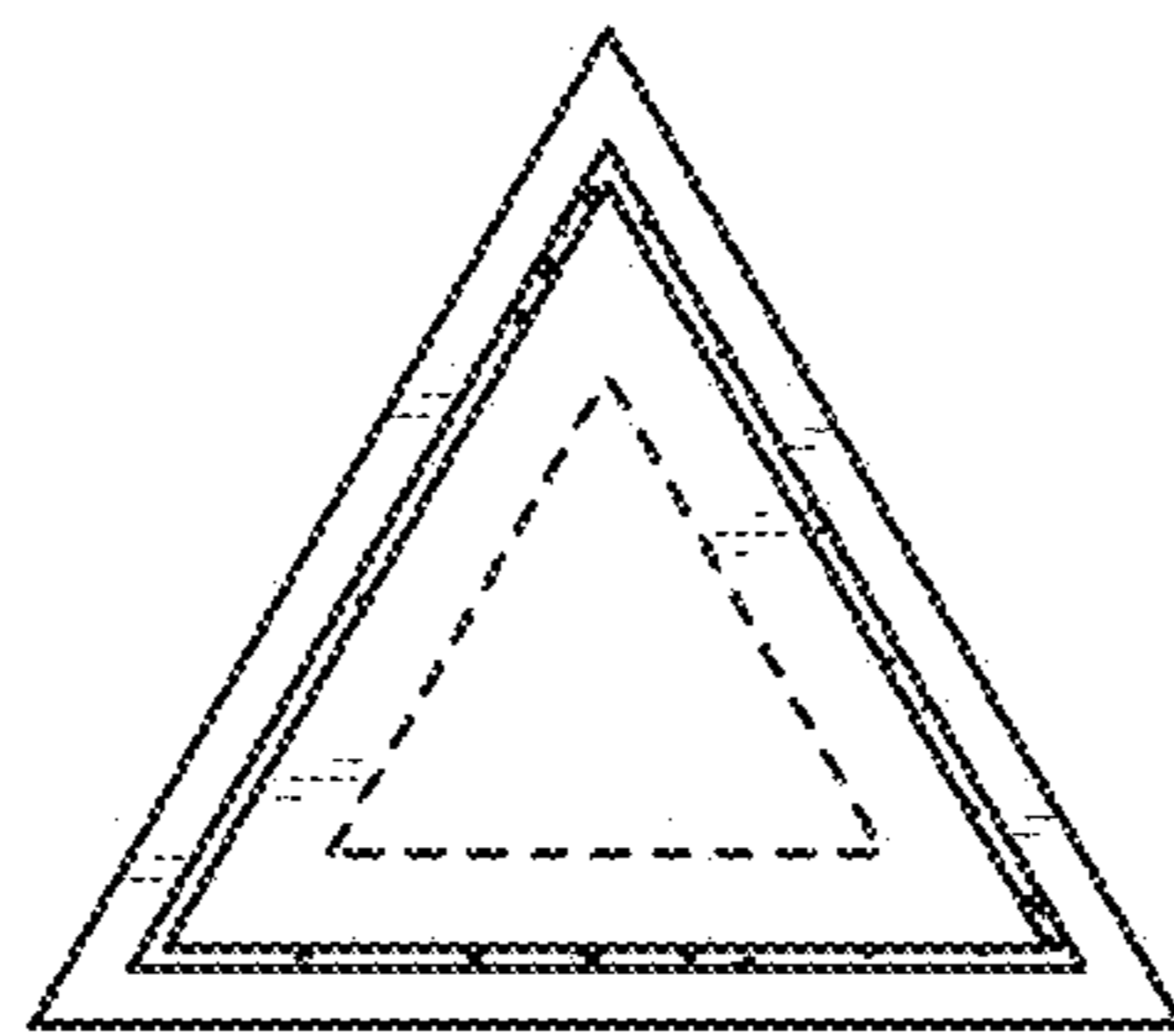

FIG. 23

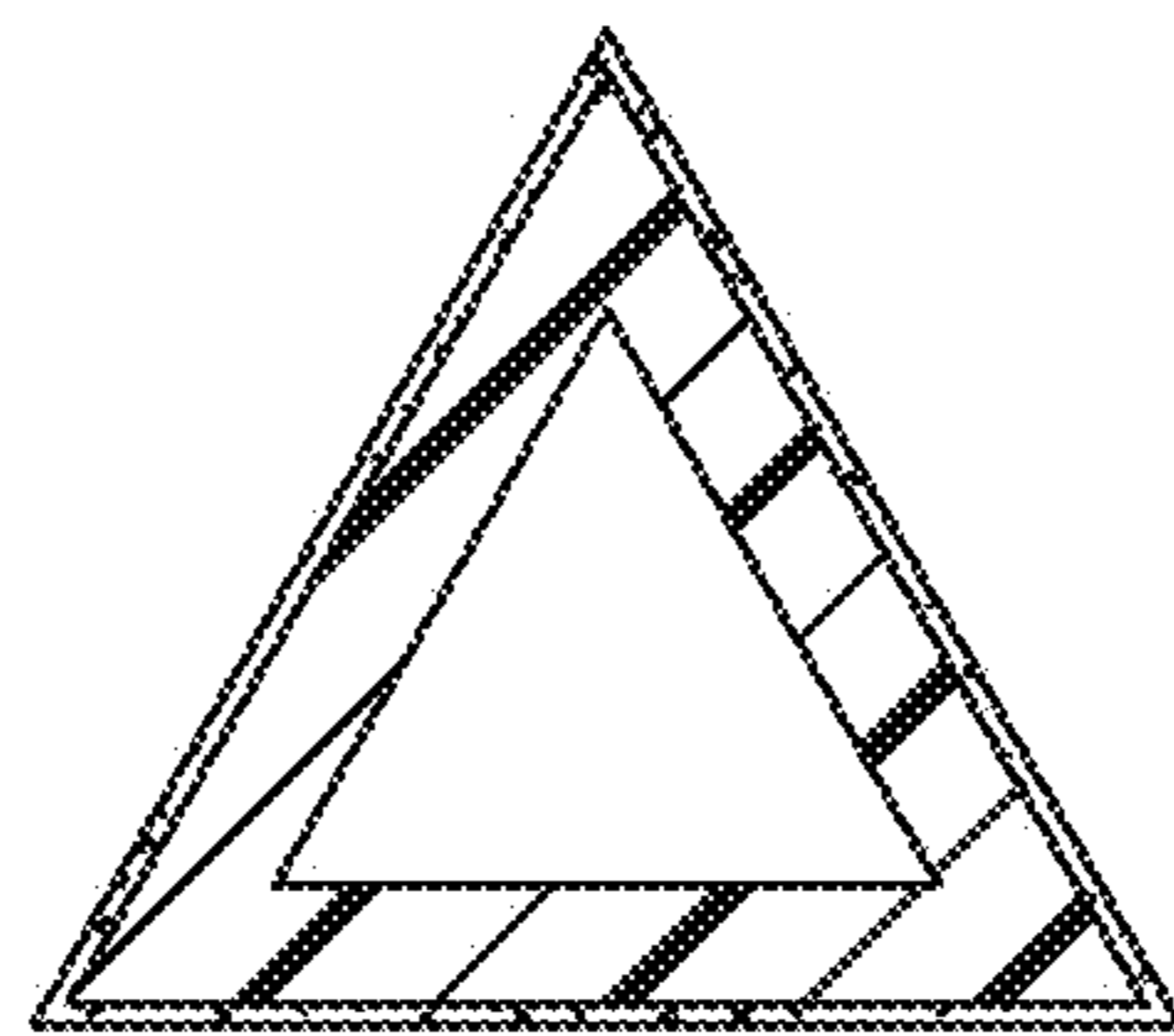

FIG. 24

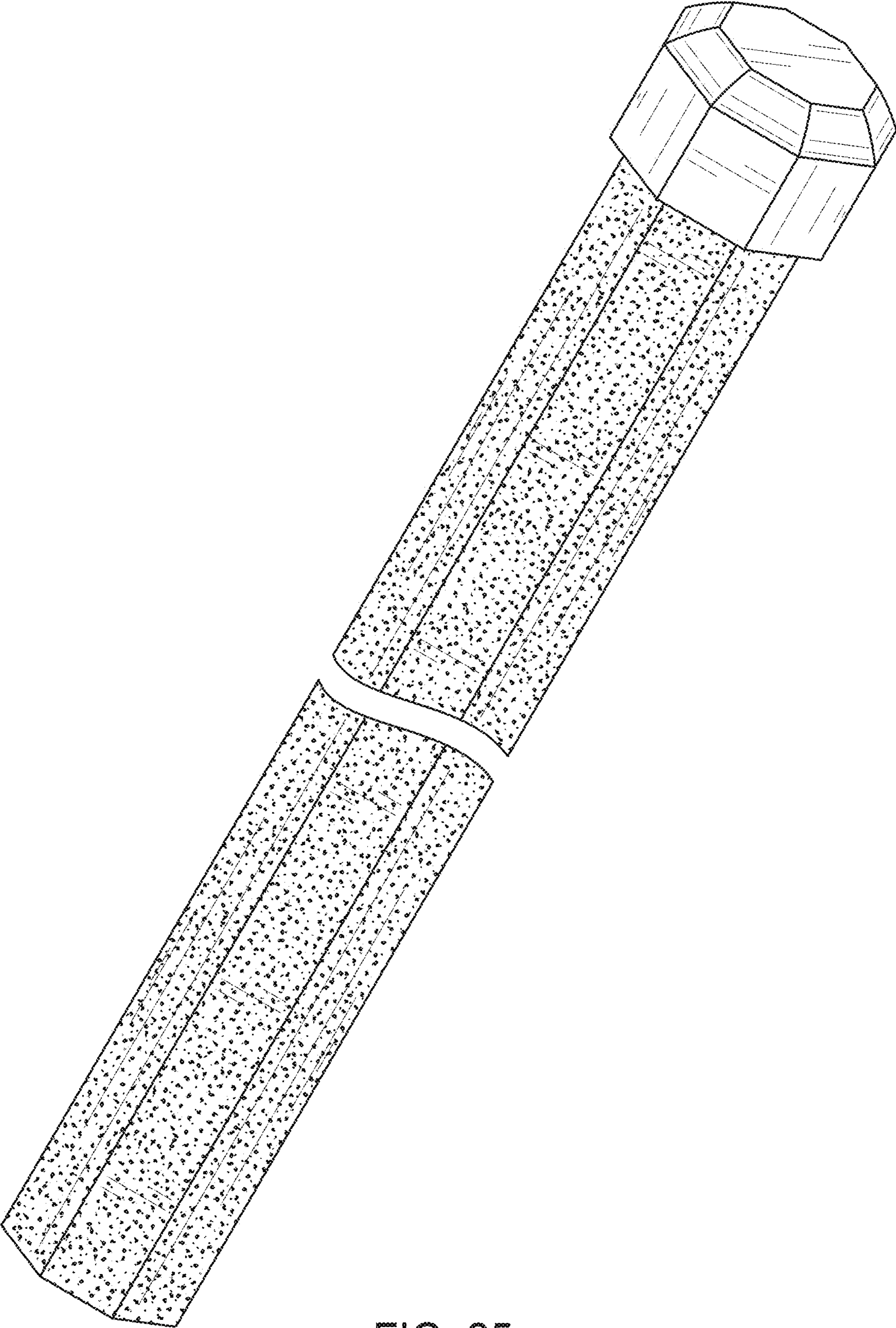

FIG. 25

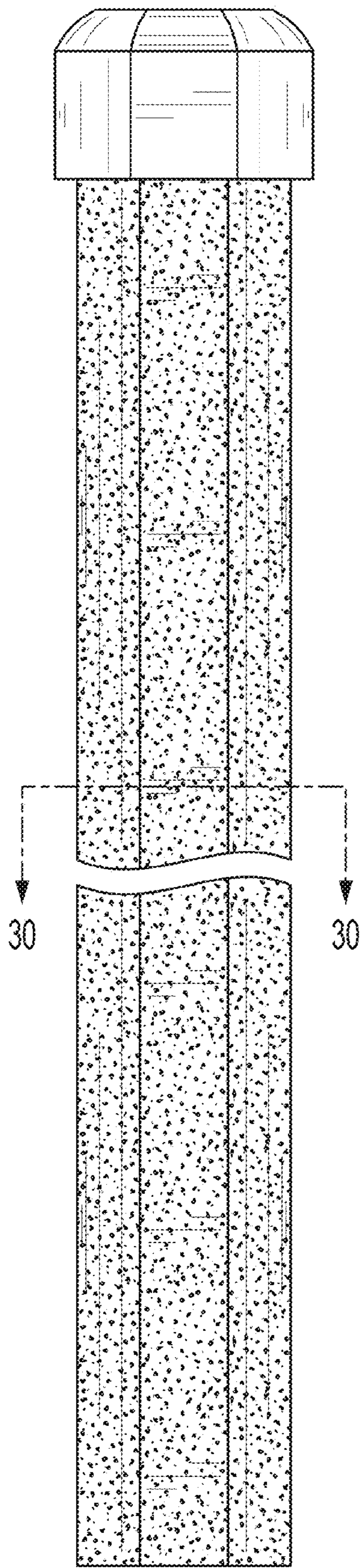

FIG. 26

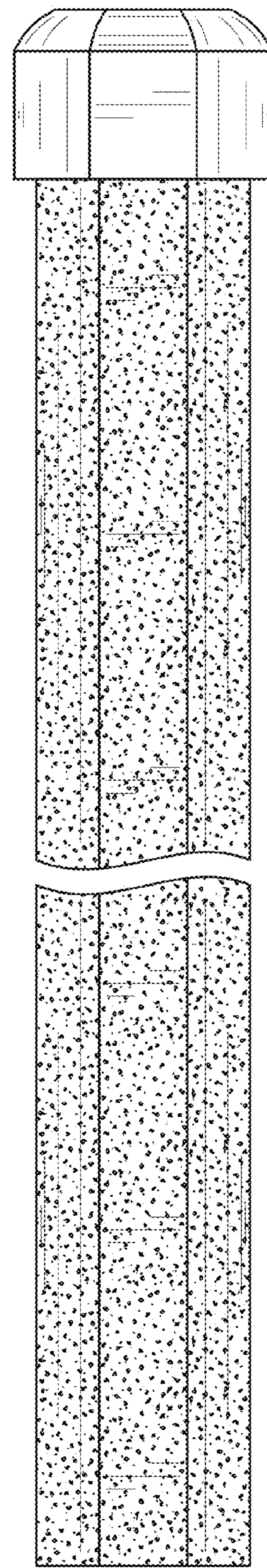

FIG. 27



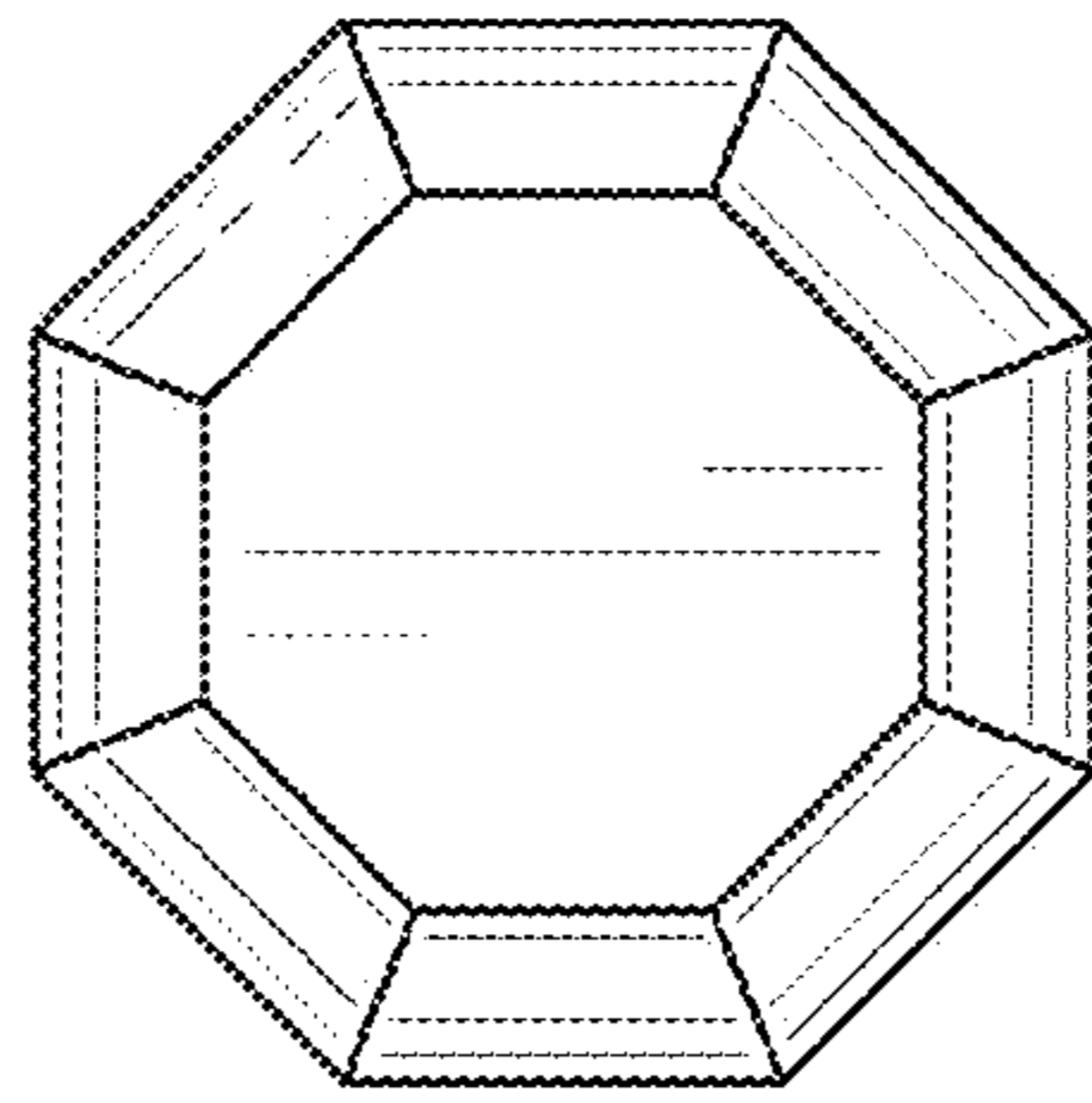

FIG. 28

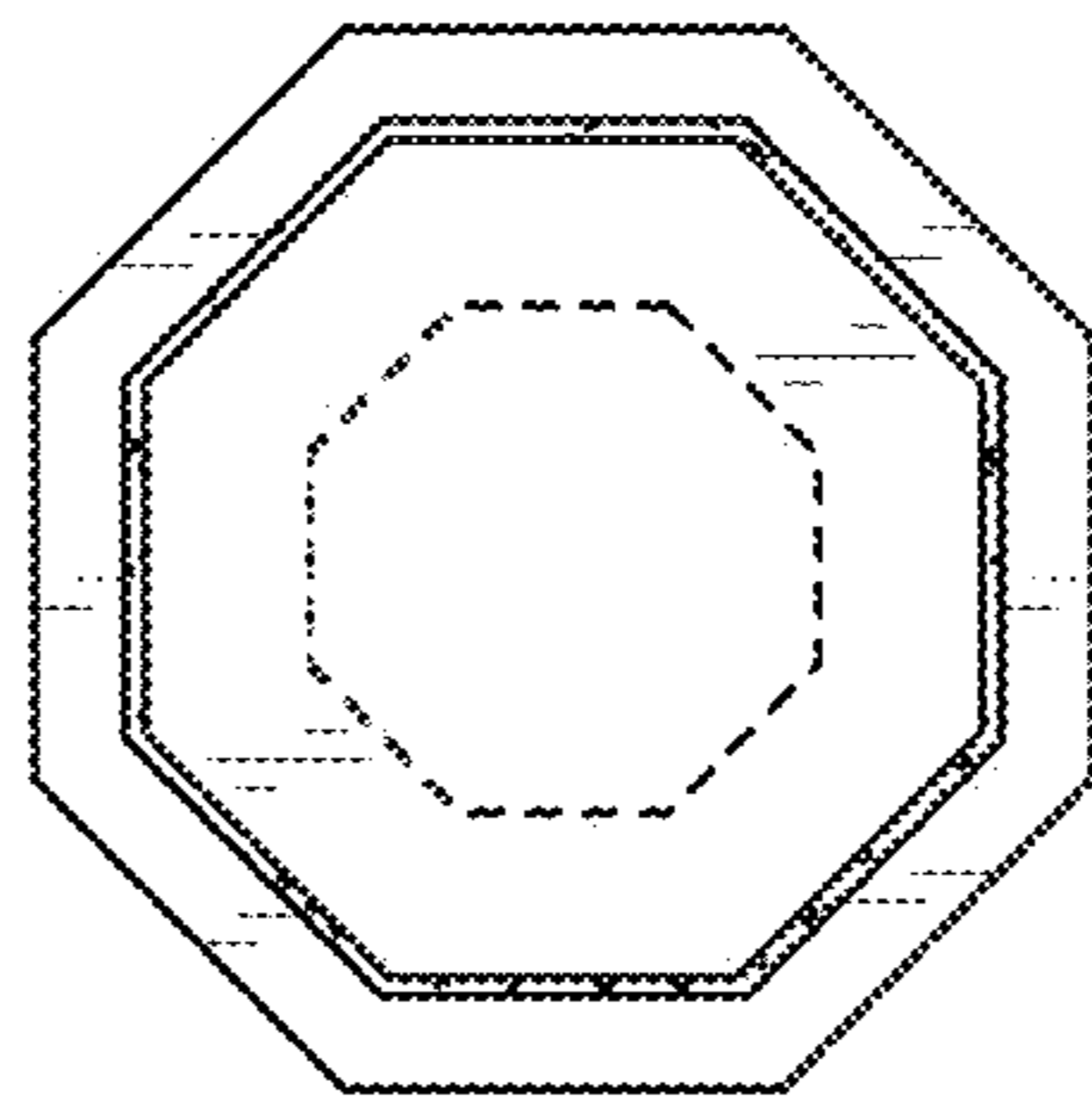

FIG. 29

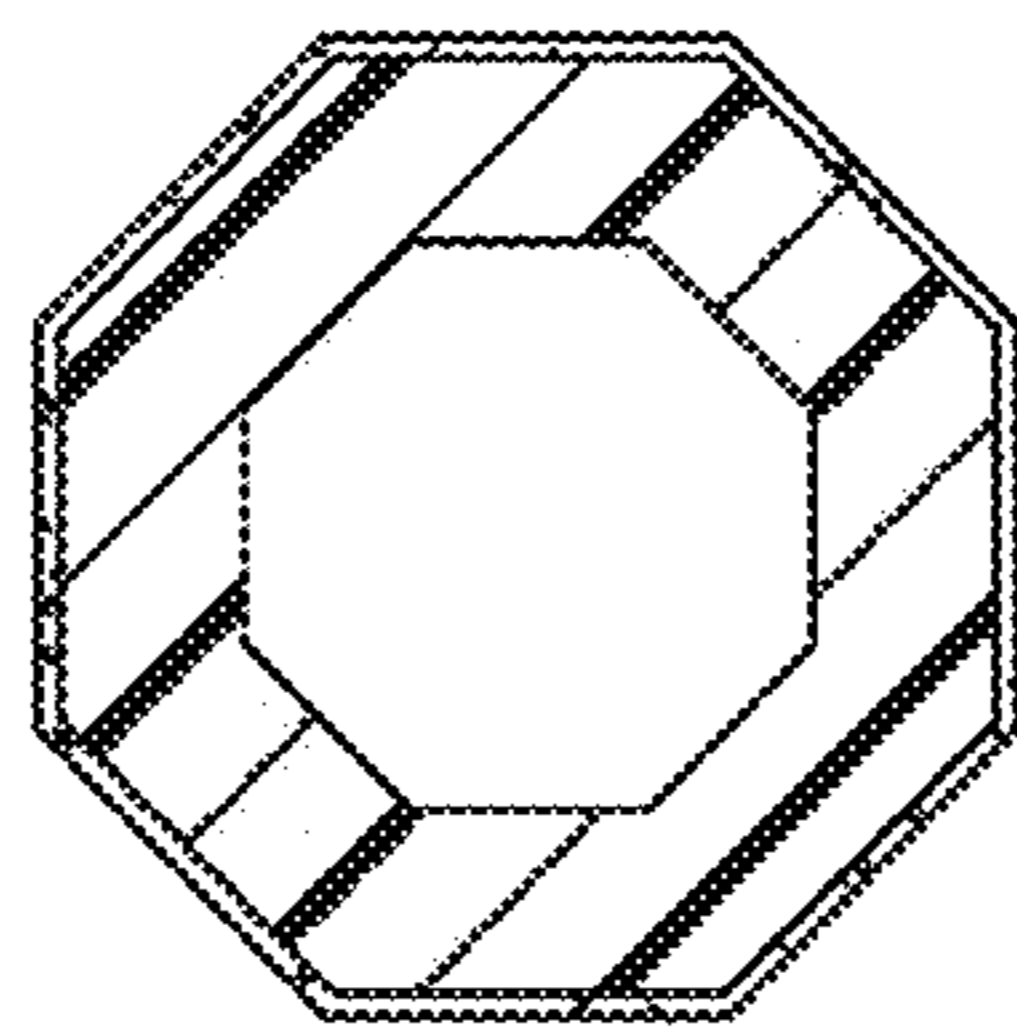

FIG. 30