



US00D877570S

(12) **United States Design Patent**
Coleman

(10) **Patent No.:** **US D877,570 S**
(45) **Date of Patent:** **** Mar. 10, 2020**

- (54) **BEVERAGE GLASS**
- (71) Applicant: **Coleman Product Designs, Limited LLC**, Denver, CO (US)
- (72) Inventor: **Andrew David Coleman**, Denver, CO (US)
- (73) Assignee: **COLEMAN PRODUCT DESIGNS, LIMITED**, Denver, CO (US)

- 2,813,651 A * 11/1957 Schlumbohm A47J 43/27
210/464
- D184,886 S * 4/1959 Nolte D7/584
- D189,393 S * 12/1960 Schlumbohm D23/356
- 3,565,281 A * 2/1971 Collie B65D 11/02
220/506
- D286,390 S * 10/1986 Groce D11/157
- D351,121 S * 10/1994 Lauchlan D11/143
- 5,423,451 A * 6/1995 Snyder A47J 47/005
206/216
- D422,101 S * 3/2000 Barraclough D26/9

(**) Term: **15 Years**

(21) Appl. No.: **29/598,834**

(22) Filed: **Mar. 29, 2017**

(51) **LOC (12) Cl.** **07-01**

(52) **U.S. Cl.**

USPC **D7/523**; D7/532

(58) **Field of Classification Search**

USPC D7/505, 507, 509, 510, 511, 523, 530,
D7/531, 532, 300.1, 512, 513, 396.1,
D7/396.2, 552.2, 553.6, 584, 672, 554.3,
D7/557, 560, 562, 635, 608, 605, 396.4;
220/592.16, 592.17; D9/453, 570, 557,
D9/556, 569; D11/143, 144, 153;
D99/25

CPC A47G 19/22; A47G 19/2205; A47G
19/2266; A47G 19/2227; B65D 1/265;
B65D 3/06; A45F 3/20

See application file for complete search history.

(56) **References Cited**

U.S. PATENT DOCUMENTS

- 599,286 A * 2/1898 McAusland A47G 19/02
220/574
- D44,059 S * 5/1913 Greer D7/523
- D69,665 S * 3/1926 Magee D7/584
- D83,298 S * 2/1931 Payne, Jr. D7/523
- 2,143,027 A 1/1939 Perry
- D137,994 S 5/1944 Mason
- D167,667 S 9/1952 Babany

FOREIGN PATENT DOCUMENTS

WO DM/081540 6/2013

OTHER PUBLICATIONS

https://www.amazon.com/Tequila-Glasses-Historically-Modern-Designs/dp/B01I209DDO?ref_=bl_dp_s_web_14750788011 Historically Modern Designs (Year: 2016).*

(Continued)

Primary Examiner — Marianne N Pandozzi

Assistant Examiner — Jae Liang

(74) *Attorney, Agent, or Firm* — VOZ Patents, LLC

(57) **CLAIM**

The ornamental design for a beverage glass, as shown and described.

DESCRIPTION

FIG. 1 is a top perspective view of a beverage glass showing my new design;

FIG. 2 is a side view thereof;

FIG. 3 is a reduced scale top view thereof;

FIG. 4 is a reduced scale bottom view thereof; and,

FIG. 5 is a cross-sectional view showing a section taken along like 5-5 of FIG. 2.

The broken lines in the drawings depict portions of the Beverage Glass that form no part of the claimed design.

1 Claim, 2 Drawing Sheets

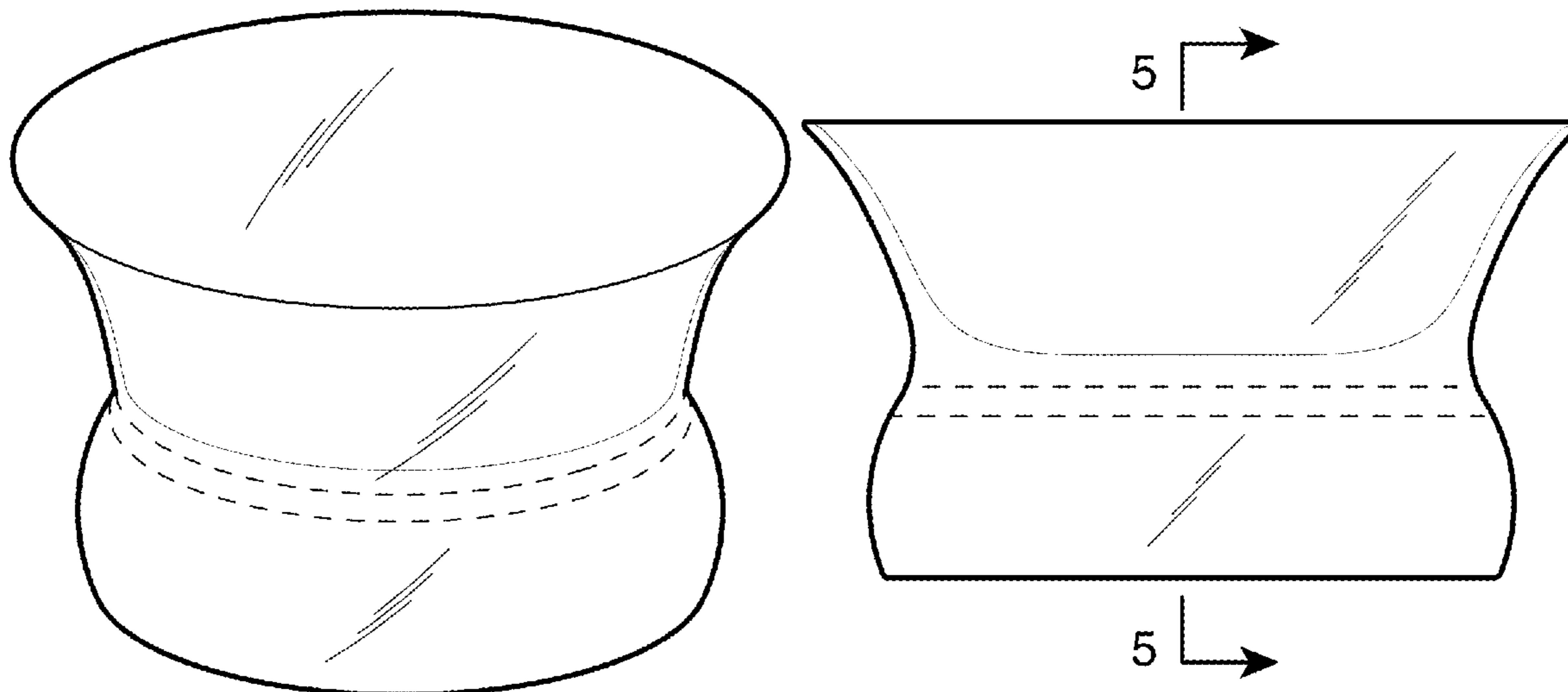

(56)

References Cited

U.S. PATENT DOCUMENTS

D471,404	S *	3/2003	Gady	D7/509
D491,019	S *	6/2004	Marsden	D7/509
D503,310	S *	3/2005	Jalet	D7/586
D515,359	S	2/2006	Andrews	
D527,223	S	8/2006	Thun	
D531,452	S	11/2006	Toth	
D533,405	S *	12/2006	Barducci	D7/523
7,178,687	B1 *	2/2007	Manderfield, Jr.	B65D 1/10 215/375
D602,309	S	10/2009	Pourounidis et al.	
D612,212	S *	3/2010	Guyot	D7/584
D615,363	S *	5/2010	Lion	D7/503
D634,635	S *	3/2011	Araujo	D9/500
D663,165	S *	7/2012	Manska	D7/507
D675,875	S	2/2013	Miller	
D684,303	S *	6/2013	Lin	D26/118
D702,591	S *	4/2014	Young	D11/143
D717,603	S	11/2014	Federighi	
D725,969	S	4/2015	Garner	
D727,090	S *	4/2015	St. Jacques	D7/387
D731,245	S	6/2015	Beller	
D742,694	S	11/2015	Malaspino	
D746,108	S	12/2015	Di Giuseppantonio	
D749,365	S	2/2016	Hume et al.	
D752,378	S *	3/2016	Wang	D7/354
2013/0273224	A1 *	10/2013	Manska	A47G 19/2205 426/493

OTHER PUBLICATIONS

https://www.amazon.com/dp/B01I209DDO/ref=sspa_dk_detail_3?psc=1 Historically Modern Designs (Year: 2016).*

* cited by examiner

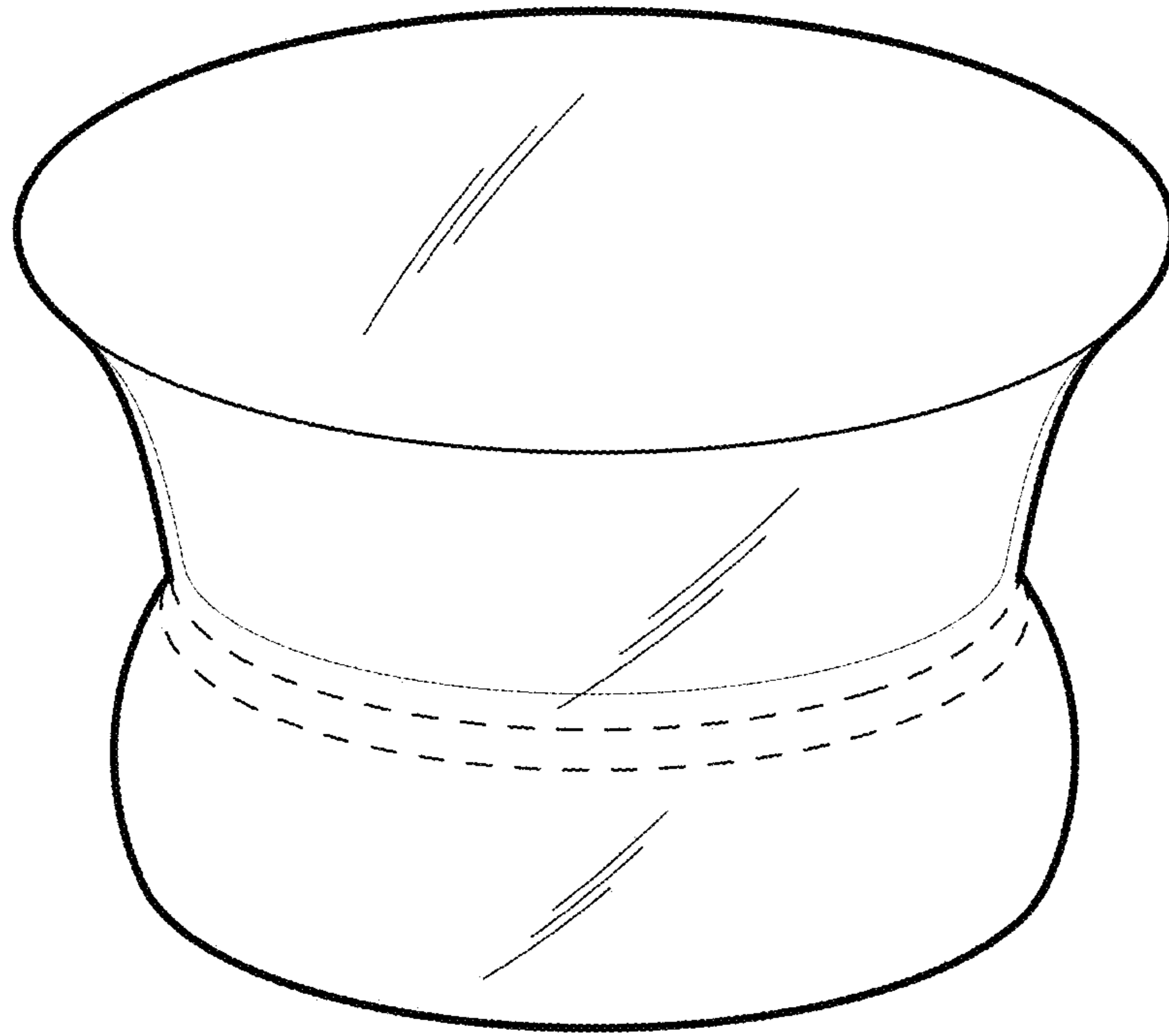

FIG. 1

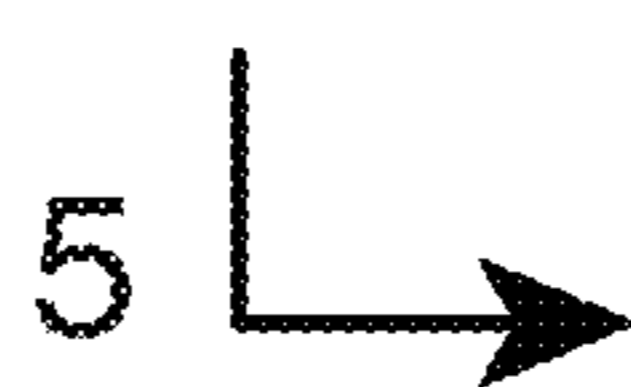
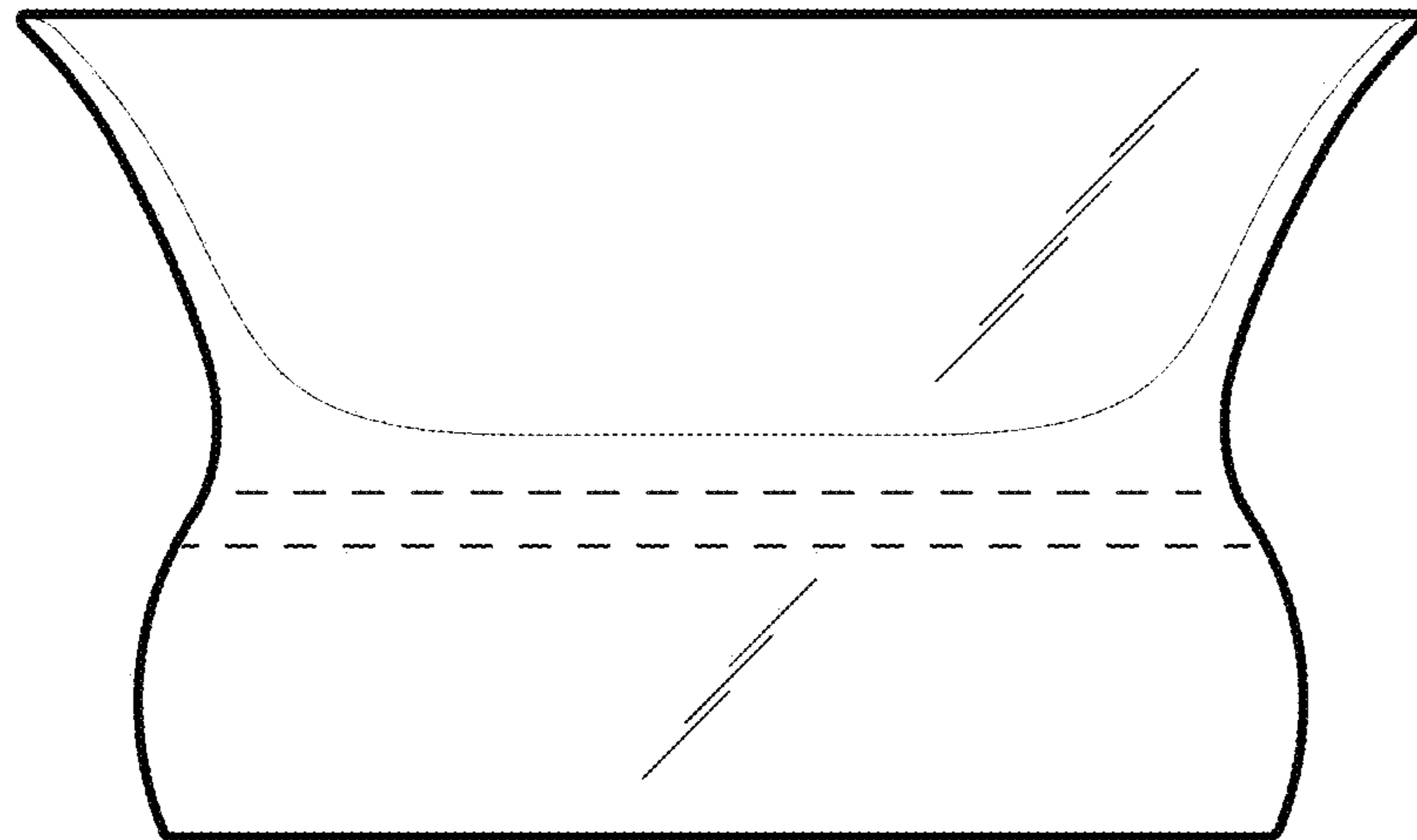

FIG. 2

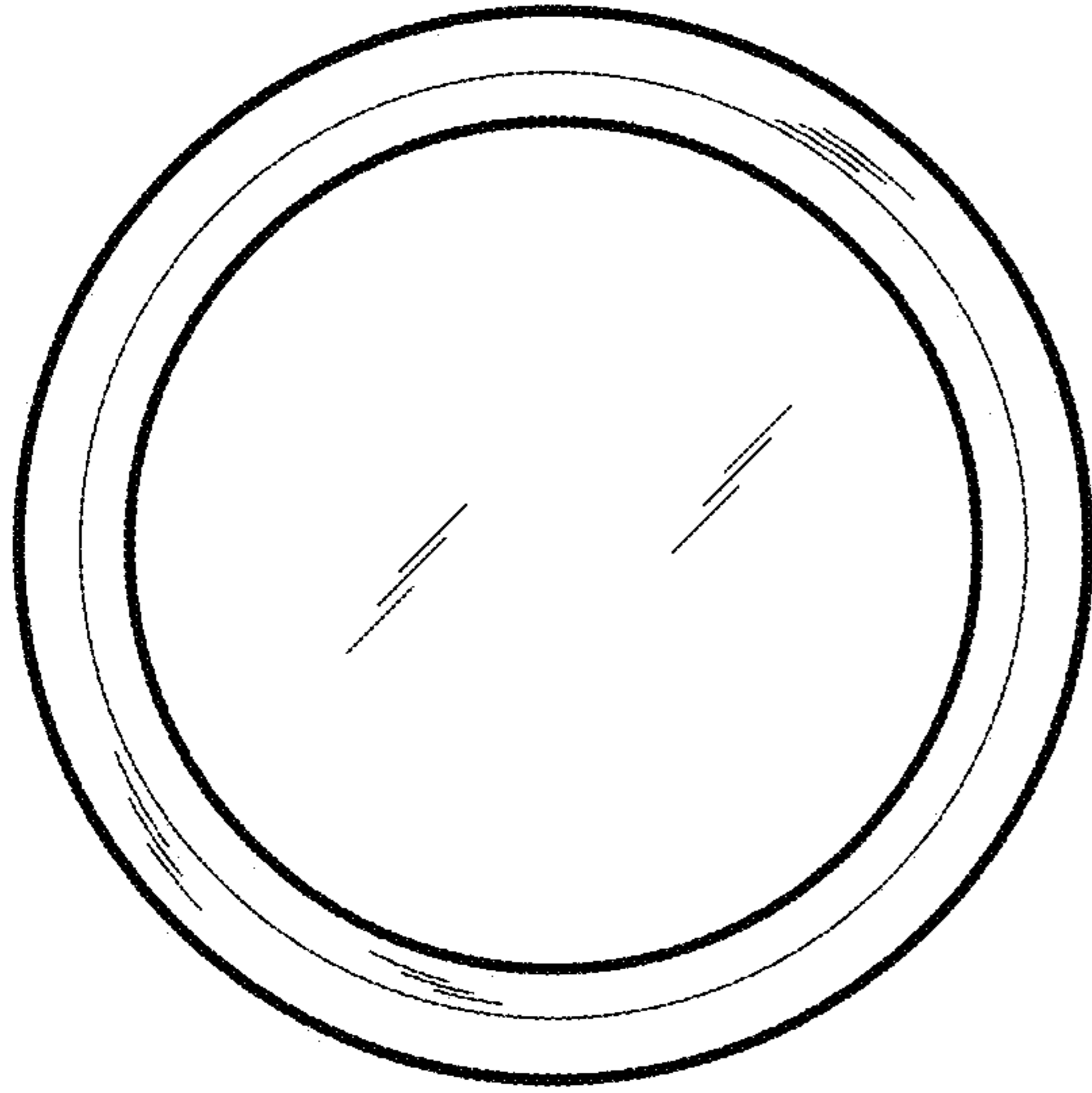

FIG. 3

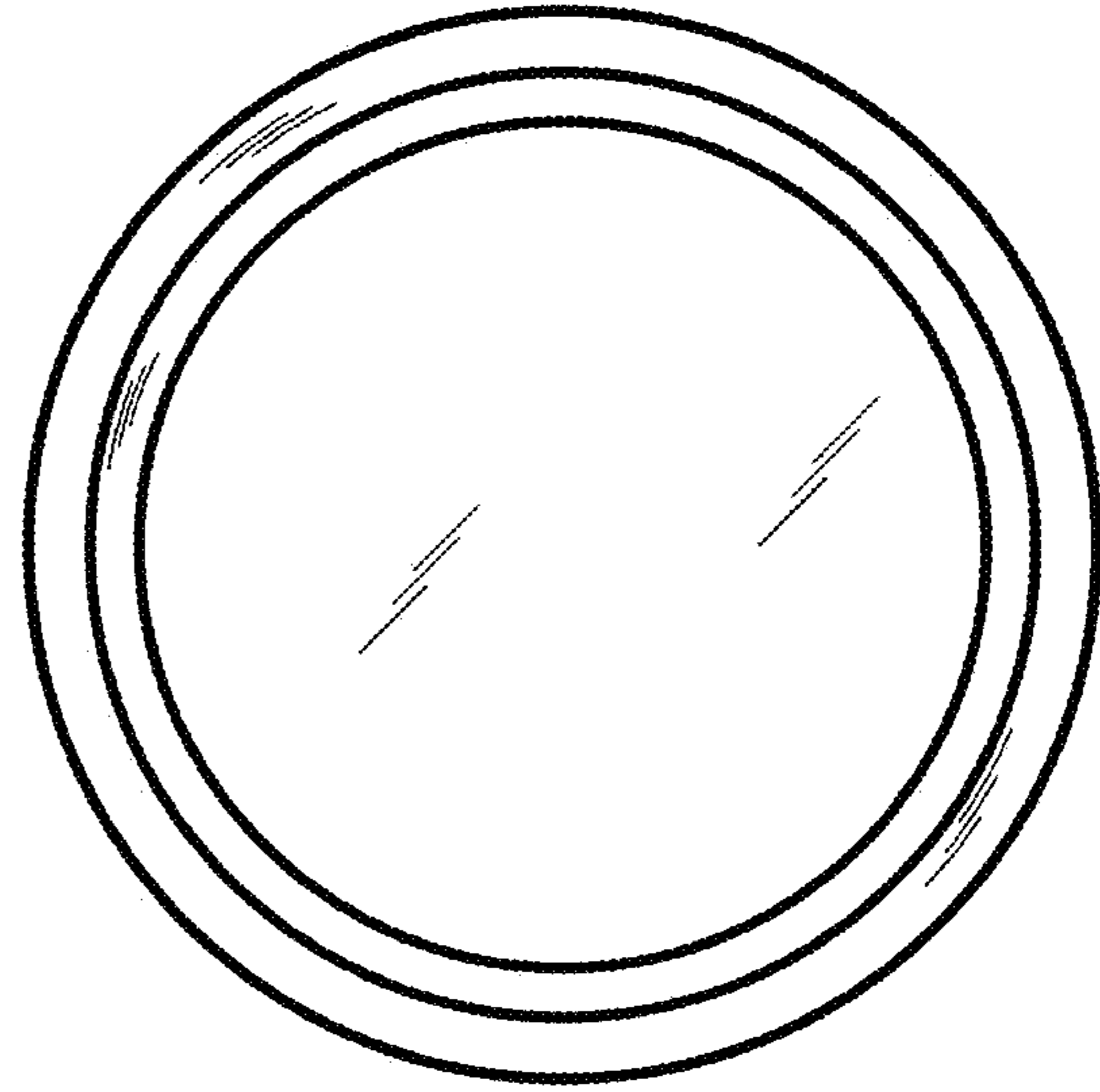

FIG. 4

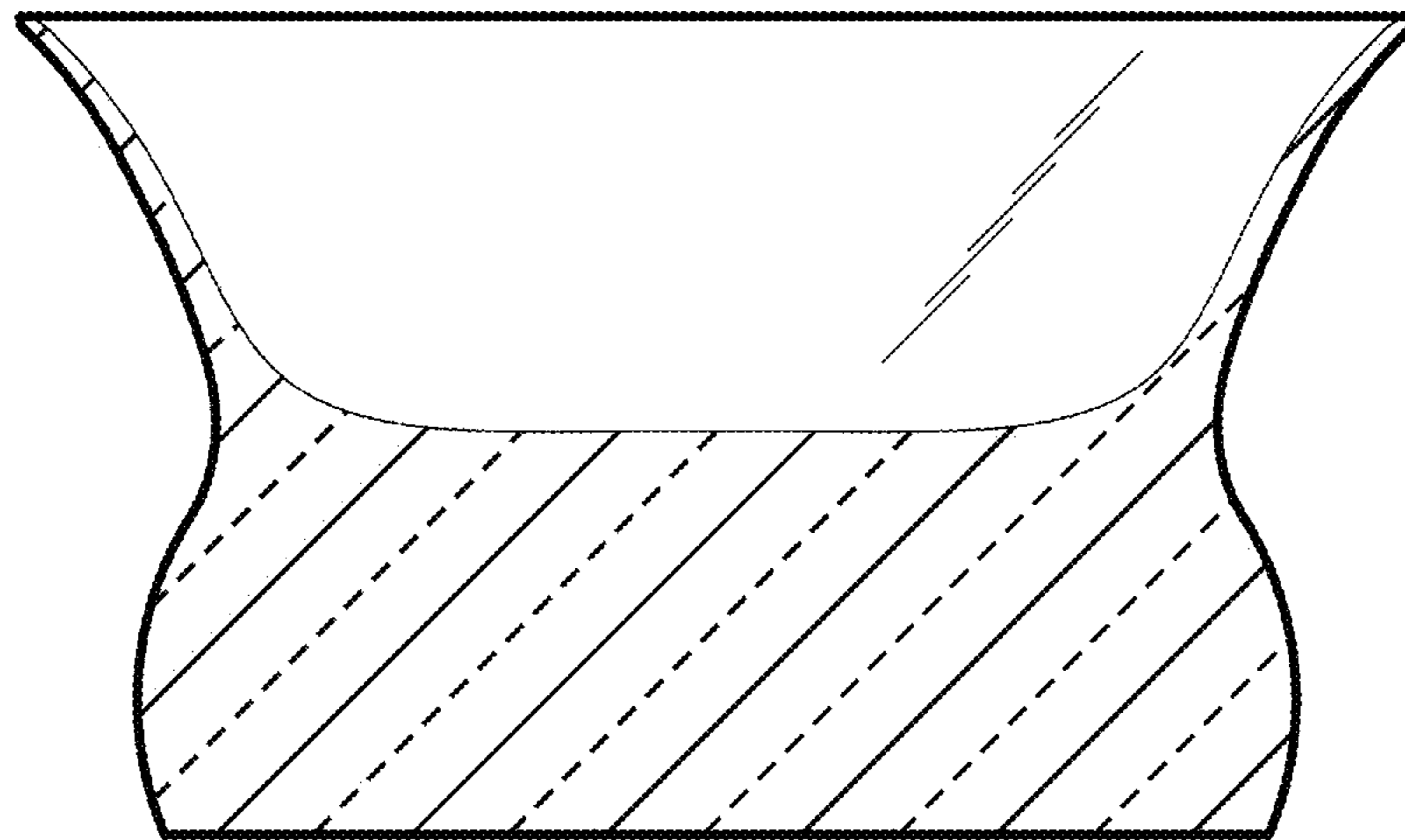

FIG. 5