



US00D877547S

(12) **United States Design Patent** (10) **Patent No.:** **US D877,547 S**  
**Dejesus et al.** (45) **Date of Patent:** **\*\* Mar. 10, 2020**

(54) **RETAIL FIXTURE**  
(71) Applicant: **Apple Inc.**, Cupertino, CA (US)  
(72) Inventors: **Manuel Dejesus**, San Francisco, CA (US); **Joshua Robert Edwards**, Santa Cruz, CA (US); **Jean-Marc Gady**, Los Altos, CA (US); **Wesley Bryan Hamm**, San Francisco, CA (US); **Russell John Kaaihue Heirakuji**, Cupertino, CA (US); **Allison Inouye**, San Francisco, CA (US); **Moritz Wilsberg**, Menlo Park, CA (US)

D248,351 S 7/1978 Bartholomew  
D264,289 S 5/1982 Klein  
D264,291 S 5/1982 Haigh  
D278,584 S 4/1985 Bromley  
D281,208 S 11/1985 Raftery  
4,765,253 A 8/1988 Schappach  
D299,893 S 2/1989 Diehl  
(Continued)

**FOREIGN PATENT DOCUMENTS**

DE 40110180-0009 7/2003  
JP D1345526 S 12/2008  
(Continued)

(73) Assignee: **Apple Inc.**, Cupertino, CA (US)

(\*\*) Term: **15 Years**

(21) Appl. No.: **29/655,963**

(22) Filed: **Jul. 9, 2018**

(51) **LOC (12) Cl.** ..... **06-06**

(52) **U.S. Cl.**  
USPC ..... **D6/675**

(58) **Field of Classification Search**  
USPC .... D6/675, 675.1, 675.4; D7/589, 590, 601, D7/602; D3/304, 313, 328  
CPC ..... A47F 5/00; A47F 5/0018; A47F 5/0043; A47F 7/0007; A47F 7/0014; B65D 21/0235; B65G 1/00; A47B 53/00; A47B 53/02

See application file for complete search history.

(56) **References Cited**

**U.S. PATENT DOCUMENTS**

D132,875 S 6/1942 Cooper  
3,003,243 A 10/1961 Kanzelberger  
D214,741 S 7/1969 Dean  
D218,903 S 10/1970 Chichester  
D242,001 S 10/1976 Carter  
D243,376 S 2/1977 Scott  
D243,982 S 4/1977 Carter

**OTHER PUBLICATIONS**

Japanese Patent Office document HB11011472, Abitare Magazine, p. 61, vol. 386 (2 Pages).

(Continued)

*Primary Examiner* — Kelley A Donnelly

(74) *Attorney, Agent, or Firm* — Sterne, Kessler, Goldstein & Fox P.L.L.C.

(57) **CLAIM**

The ornamental design for a retail fixture, as shown and described.

**DESCRIPTION**

FIG. 1 is a top front perspective view of a retail fixture showing the claimed design;  
FIG. 2 is a front view thereof;  
FIG. 3 is a rear view thereof;  
FIG. 4 is a left side view thereof;  
FIG. 5 is a right side view thereof;  
FIG. 6 is a top view thereof; and,  
FIG. 7 is a bottom view thereof.  
The broken lines in the figures show portions of the retail fixture that form no part of the claimed design.

**1 Claim, 7 Drawing Sheets**

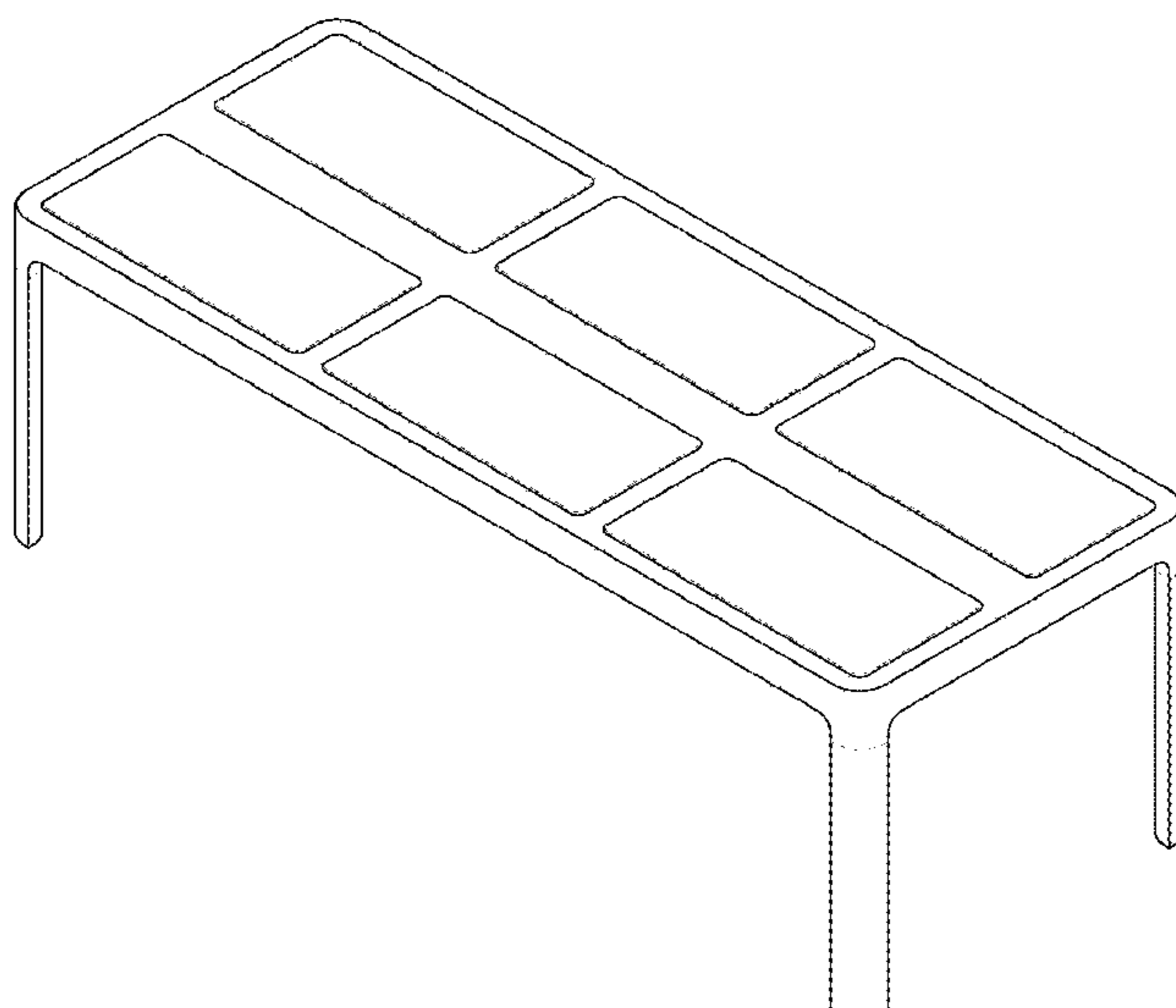

(56)

References Cited

U.S. PATENT DOCUMENTS

D300,889 S 5/1989 Bartlett  
 D322,371 S 12/1991 Rosen  
 D329,764 S \* 9/1992 Evans ..... D6/675.5  
 D350,661 S 9/1994 Klein  
 D399,684 S 10/1998 Glass  
 D407,245 S 3/1999 Lewis  
 D424,841 S 5/2000 Newhouse  
 D426,405 S 6/2000 Newhouse  
 D447,892 S 9/2001 Shih  
 D448,217 S \* 9/2001 Ullman ..... D6/675  
 D453,083 S 1/2002 Hokanson  
 D459,621 S 7/2002 O'Hare et al.  
 D468,562 S 1/2003 Chang  
 D484,717 S 1/2004 de Blois  
 D487,655 S 3/2004 Varsi  
 D493,306 S 7/2004 Britschgi  
 D503,298 S 3/2005 Juneau  
 D513,676 S 1/2006 Vaaler  
 D518,981 S 4/2006 O'Hare  
 D522,274 S 6/2006 Coval  
 D522,284 S \* 6/2006 Shapiro ..... D6/675  
 D531,431 S 11/2006 Domack et al.  
 D558,489 S 1/2008 Christensen  
 D575,081 S 8/2008 Miyakawa  
 D583,590 S 12/2008 Ellouz  
 D585,218 S 1/2009 Hamilton et al.  
 D590,185 S 4/2009 Karashima  
 D591,079 S 4/2009 Singler et al.  
 D591,979 S 5/2009 Singler et al.  
 D604,063 S 11/2009 Oshinomi et al.  
 D613,968 S 4/2010 Lambert  
 D620,288 S 7/2010 Stiker Metral  
 D646,507 S 10/2011 Delmestri  
 D647,333 S 10/2011 Navone  
 D649,380 S 11/2011 Townsend  
 D649,381 S 11/2011 Mainzer  
 D655,949 S 3/2012 Villiers et al.  
 D657,978 S 4/2012 Hamm et al.  
 D659,433 S 5/2012 Starck  
 D661,129 S 6/2012 Schweikarth et al.  
 D670,104 S 11/2012 Li et al.  
 D674,625 S 1/2013 Mecherle et al.  
 D675,462 S 2/2013 Petrovich  
 D678,696 S 3/2013 Hamm et al.  
 D679,521 S 4/2013 Hamm et al.  
 D683,161 S 5/2013 Polloni  
 D684,413 S 6/2013 Schmitt  
 D688,494 S 8/2013 Hamm et al.  
 D689,307 S 9/2013 Burt  
 D693,156 S 11/2013 Hamm et al.  
 D713,658 S 9/2014 Tio et al.  
 D717,572 S 11/2014 Morrison  
 D725,947 S 4/2015 Tio et al.  
 D726,460 S 4/2015 Arnon et al.  
 D728,281 S 5/2015 Heirakuji et al.  
 D729,560 S 5/2015 Hamm et al.  
 D734,078 S 7/2015 Bougay  
 D734,965 S 7/2015 Tio et al.  
 D736,017 S 8/2015 Rose  
 D746,616 S 1/2016 Akana et al.  
 D753,419 S 4/2016 Heirakuji et al.  
 D757,464 S 5/2016 Chiang  
 D758,106 S 6/2016 Hamm et al.  
 D766,630 S \* 9/2016 Akana ..... D6/691.1  
 D766,631 S 9/2016 Akana et al.

D766,632 S 9/2016 Akana et al.  
 D766,633 S 9/2016 Akana et al.  
 D767,310 S 9/2016 Akana et al.  
 D769,654 S 10/2016 Akana et al.  
 D773,868 S 12/2016 Schwalbach et al.  
 D776,471 S 1/2017 Mandon et al.  
 D779,244 S 2/2017 Akana et al.  
 D780,491 S 3/2017 Magargee et al.  
 D781,086 S 3/2017 Velez et al.  
 D783,324 S 4/2017 Akana et al.  
 9,635,931 B2 5/2017 Mandon et al.  
 D788,506 S 6/2017 Choi  
 D790,262 S 6/2017 Akana et al.  
 D799,250 S 10/2017 Schwalbach et al.  
 D799,866 S 10/2017 Pocci et al.  
 D810,476 S \* 2/2018 Heirakuji ..... D6/675  
 D810,482 S 2/2018 Modlin  
 D815,474 S \* 4/2018 Modlin ..... D6/691.2  
 D833,789 S \* 11/2018 Schwalbach ..... D6/707.19  
 D837,578 S \* 1/2019 Rundle ..... D6/686  
 D855,358 S \* 8/2019 Adler ..... D6/644  
 D865,413 S \* 11/2019 Chapuis ..... D6/675  
 D865,419 S \* 11/2019 Chavarria ..... D6/686  
 D867,035 S \* 11/2019 Brugger ..... D6/675  
 2005/0268823 A1 12/2005 Bakker et al.  
 2006/0096506 A1 5/2006 Brauning et al.  
 2009/0095204 A1 4/2009 Levy et al.  
 2010/0290215 A1 11/2010 Metcalf et al.  
 2014/0124641 A1 5/2014 Kassanoff et al.  
 2015/0150370 A1 6/2015 Korb et al.  
 2016/0064995 A1 \* 3/2016 Schwalbach ..... A47F 7/022  
 320/108  
 2016/0255957 A1 9/2016 Tsuchiyama et al.  
 2017/0051771 A1 2/2017 Feinstein

FOREIGN PATENT DOCUMENTS

KR 167611 8/1995  
 WO DM-074057 10/2010  
 WO DM/078433 6/2012

OTHER PUBLICATIONS

Japanese Patent Office Document HB06003569, dated by JPO Oct. 31, 1993.  
 Japanese Patent Office Document HA14019873, dated by JPO Dec. 1, 2012.  
 Japanese Patent Office Document HA24006766, dated by JPO Sep. 1, 2012.  
 Japanese Patent Office Document HC13007386.  
 Neil Hughes, "Apple retail stores 'bulging at the seams' at 8400 average square feet," Appleinsider.com, dated May 8, 2012, accessed at <[http://appleinsider.com/articles/12/05/08/apple\\_retail\\_stores\\_bulging\\_at\\_the\\_seams\\_at\\_8400\\_average\\_square\\_feet](http://appleinsider.com/articles/12/05/08/apple_retail_stores_bulging_at_the_seams_at_8400_average_square_feet)>, accessed on Oct. 10, 2014, 2 pages.  
 Valentina Palladino, "Apple Store Receives Trademark for 'Distinctive Design and Layout,'" Wired.com, dated Jan. 30, 2013, accessed at <<http://www.wired.com/2013/01/apple-store-trademark/>>, accessed on Oct. 10, 2014, 2 pages.  
 "Apple Granted 8 Design Patents for All-New Apple Watch Tables," Patently Apple, Nov. 28, 2015 [retrieved on Aug. 15, 2016]. Retrieved from the Internet: <<http://www.patentlyapple.com/patently-apple/2015/11/apple-granted-8-design-patents-for-all-new-apple-watch-tables.html>>, 6 pages.

\* cited by examiner

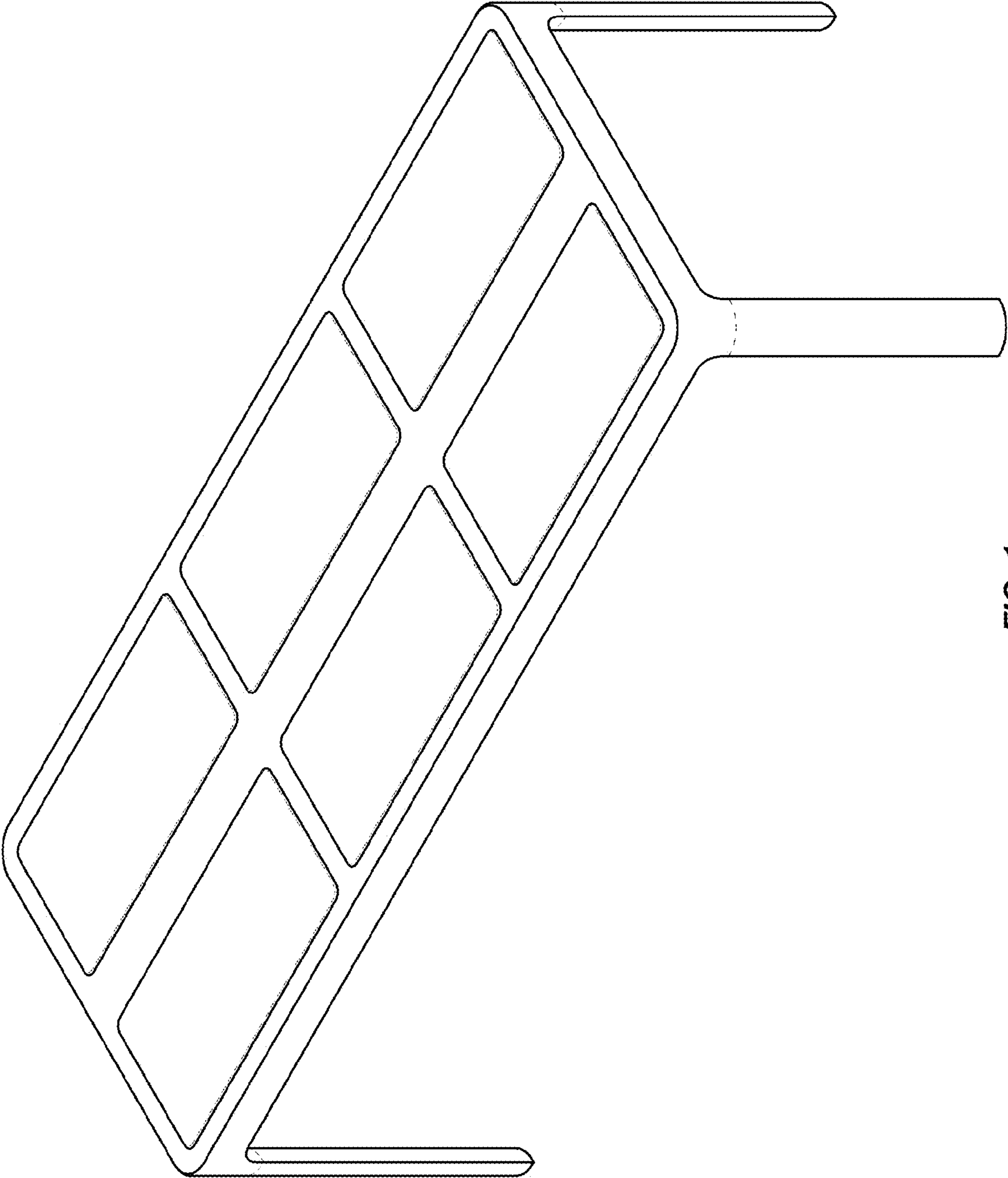

FIG. 1

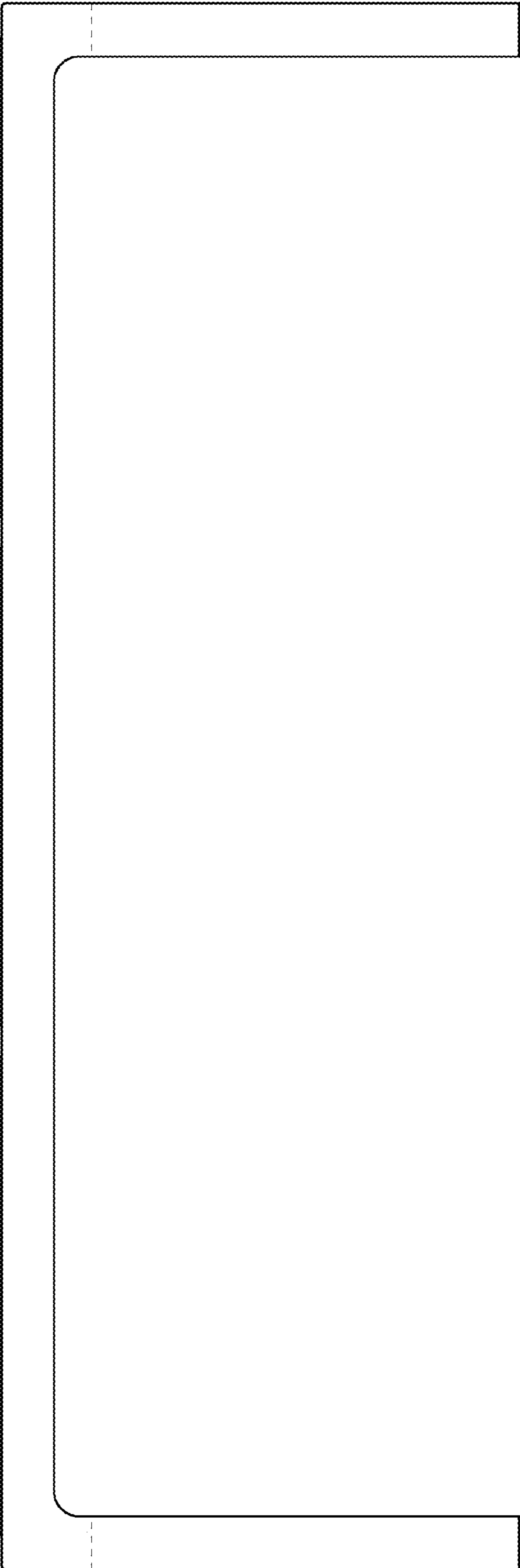

FIG. 2

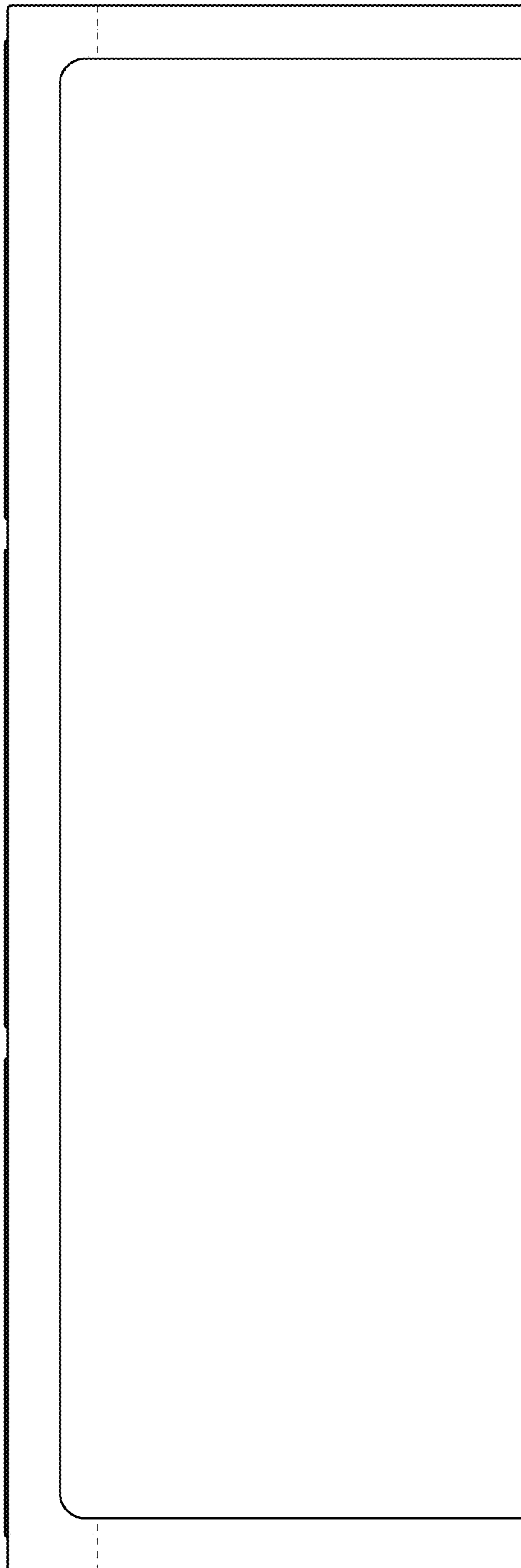

FIG. 3

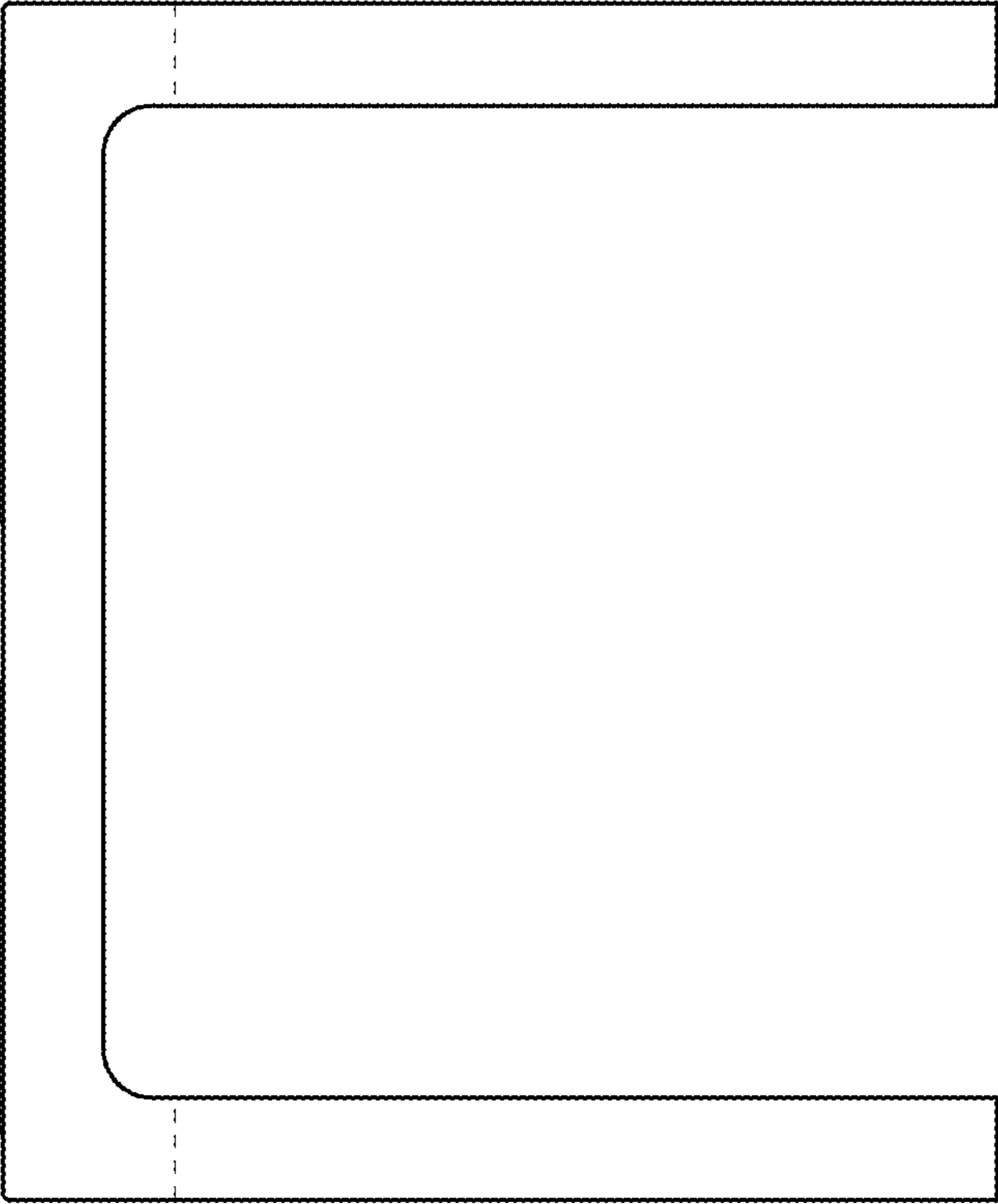

FIG. 4

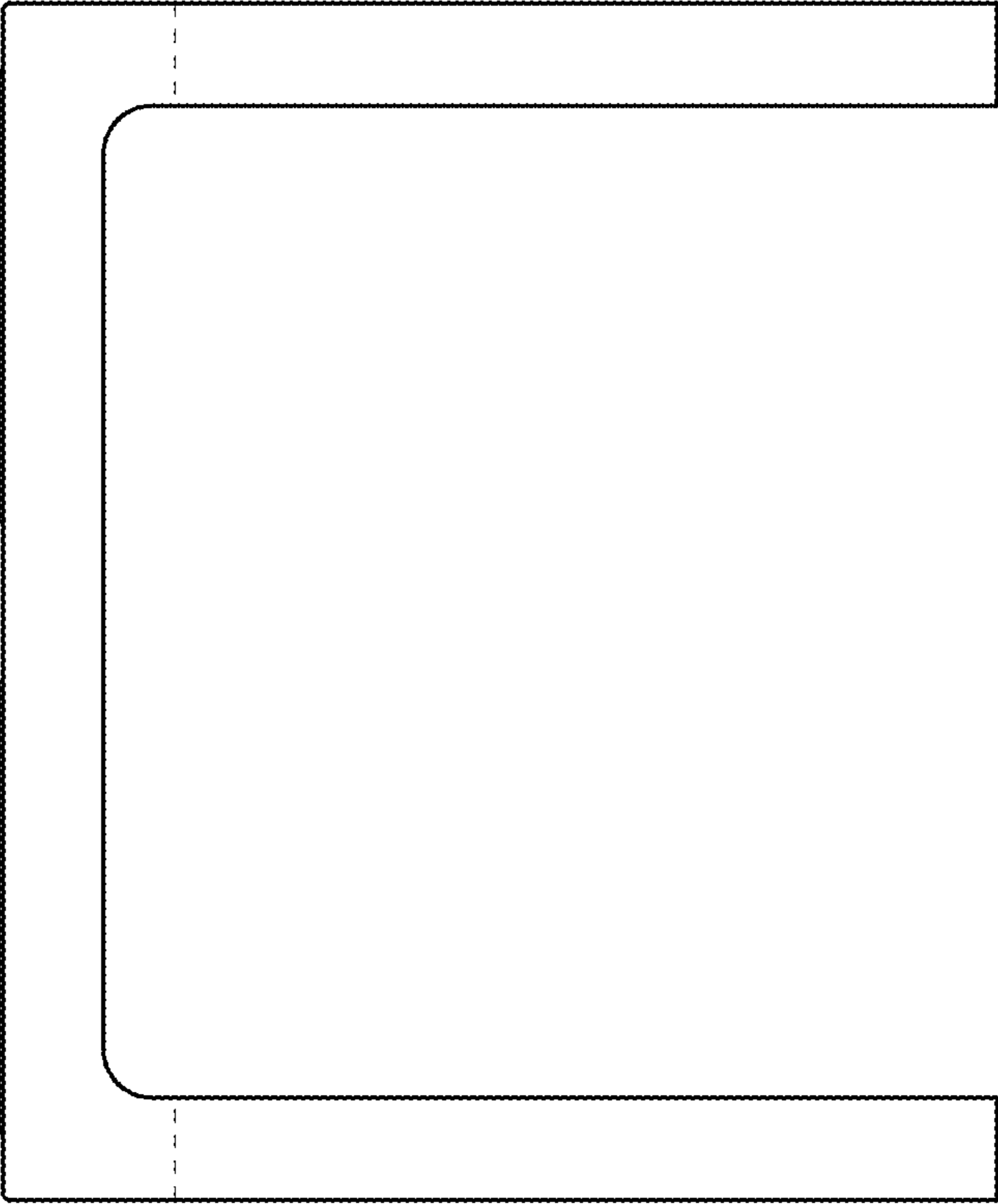

FIG. 5

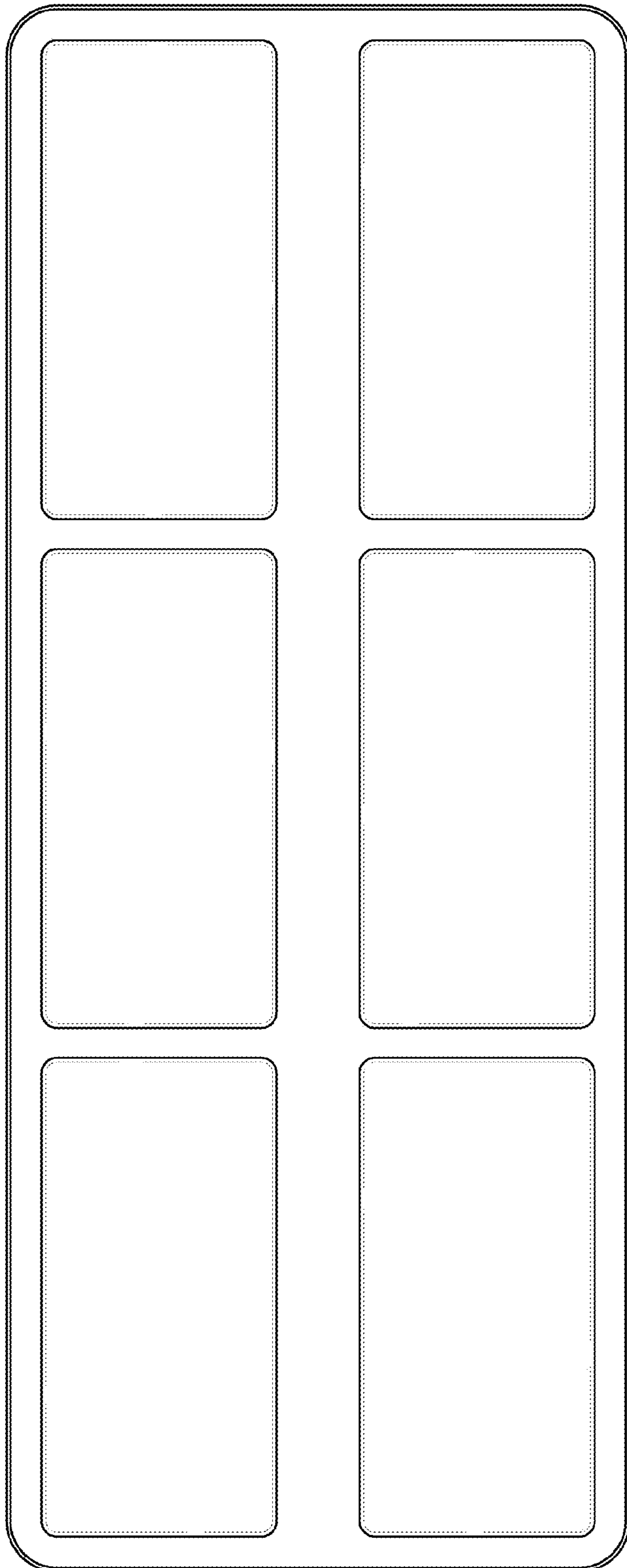

FIG. 6



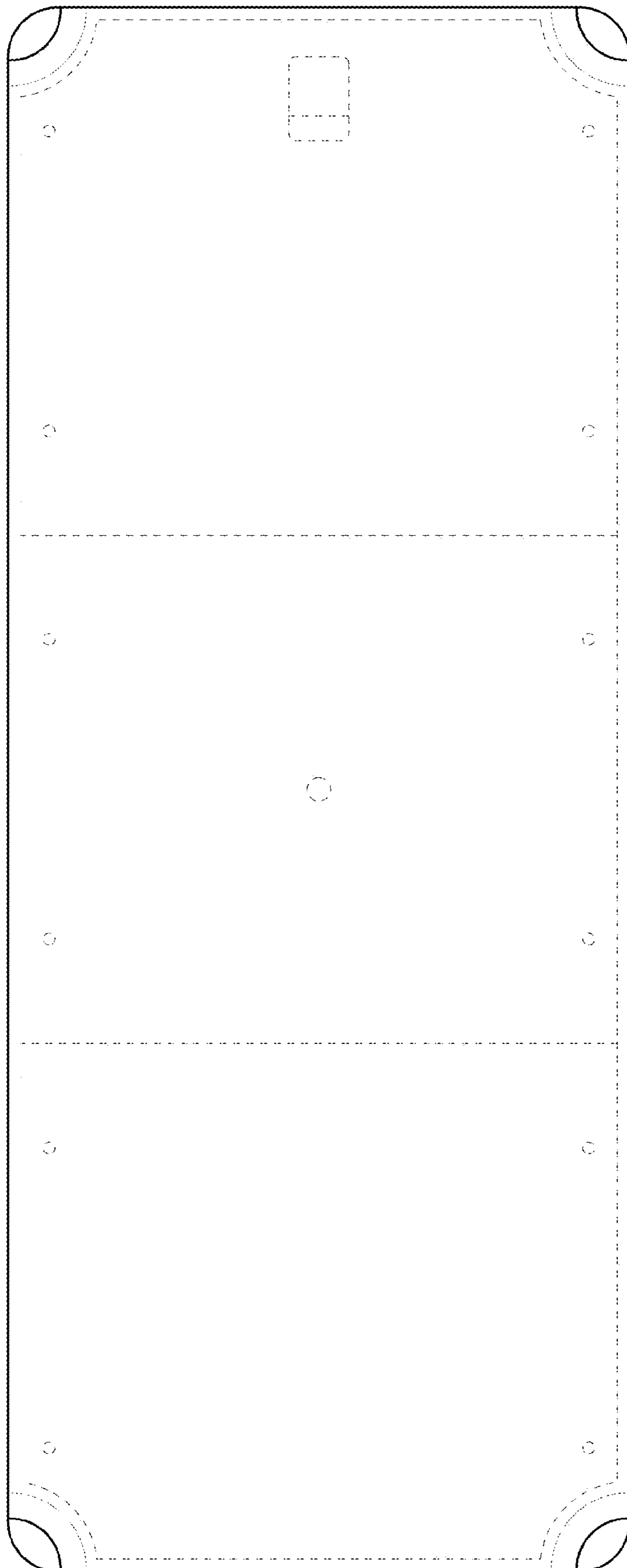

FIG. 7