



US00D877467S

(12) **United States Design Patent**  
**Taylor**

(10) **Patent No.:** **US D877,467 S**

(45) **Date of Patent:** **\*\* Mar. 10, 2020**

(54) **SHOE SOLE**

(71) Applicant: **PUMA SE**, Herzogenaurach (DE)

(72) Inventor: **Daniel Taylor**, Nuremberg (DE)

(73) Assignee: **PUMA SE**, Herzogenaurach (DE)

(\*\*) Term: **15 Years**

(21) Appl. No.: **29/657,237**

(22) Filed: **Jul. 20, 2018**

(30) **Foreign Application Priority Data**

Jul. 9, 2018 (EM) ..... 005490554-0002

(51) **LOC (12) Cl.** ..... **02-04**

(52) **U.S. Cl.**  
USPC ..... **D2/947; D2/953**

(58) **Field of Classification Search**  
USPC ..... D2/902, 906, 908, 916, 918, 925,  
D2/946-962, 977; 36/3 B, 22 R, 24.5,  
36/25 R, 28, 32 R, 34 R, 59 C, 67 A, 103  
CPC ..... A43B 13/00; A43B 13/02; A43B 13/023;  
A43B 13/026; A43B 13/04; A43B 13/08;  
A43B 13/10; A43B 13/12; A43B 13/14;  
A43B 13/141; A43B 13/143; A43B  
13/16; A43B 13/18; A43B 13/181; A43B  
13/187; A43B 13/189; A43B 13/20; A43B  
13/22; A43B 13/223; A43B 13/24; A43B  
13/28; A43B 13/30; A43B 13/32; A43B  
13/34; A43B 13/36  
See application file for complete search history.

(56) **References Cited**

**U.S. PATENT DOCUMENTS**

D307,212 S \* 4/1990 Aveni ..... D2/953  
D322,506 S \* 12/1991 Rogers ..... D2/977  
D323,418 S \* 1/1992 Hatfield ..... D2/977  
D323,735 S \* 2/1992 Aveni ..... D2/977

D324,293 S \* 3/1992 Rogers ..... D2/977  
D325,464 S \* 4/1992 Smith ..... D2/977  
D327,165 S \* 6/1992 Hatfield ..... D2/953  
D329,529 S \* 9/1992 Hatfield ..... D2/977  
D330,797 S \* 11/1992 Lucas ..... D2/977  
D330,798 S \* 11/1992 Hatfield ..... D2/977  
D330,970 S \* 11/1992 Hatfield ..... D2/977  
D331,143 S \* 11/1992 McDonald ..... D2/977  
D333,034 S \* 2/1993 McDonald ..... D2/953  
D333,551 S \* 3/1993 Bailey ..... D2/977  
D334,275 S \* 3/1993 Miller ..... D2/902  
D334,279 S \* 3/1993 Teague ..... D2/977  
D334,650 S \* 4/1993 Teague ..... D2/977  
D334,832 S \* 4/1993 Hatfield ..... D2/977  
D335,015 S \* 4/1993 Lozano ..... D2/977  
D335,018 S \* 4/1993 Avar ..... D2/977  
D335,761 S \* 5/1993 Smith ..... D2/977

(Continued)

*Primary Examiner* — T Chase Nelson

(74) *Attorney, Agent, or Firm* — Leydig, Voit & Mayer,  
Ltd.

(57) **CLAIM**

The ornamental design for a shoe sole, as shown and described.

**DESCRIPTION**

FIG. 1 is a lateral side view of a shoe sole showing my new design;  
FIG. 2 is a front view thereof;  
FIG. 3 is a medial side view thereof;  
FIG. 4 is a rear view thereof;  
FIG. 5 is a front-top perspective view thereof;  
FIG. 6 is a bottom view thereof; and  
FIG. 7 is a front-lateral perspective view thereof; and,  
FIG. 8 is a top view thereof.

The broken lines on the shoe sole depict portions of the sole that form no part of the claimed design, while the other broken lines depict environmental structure that also forms no part of the claimed design.

**1 Claim, 8 Drawing Sheets**

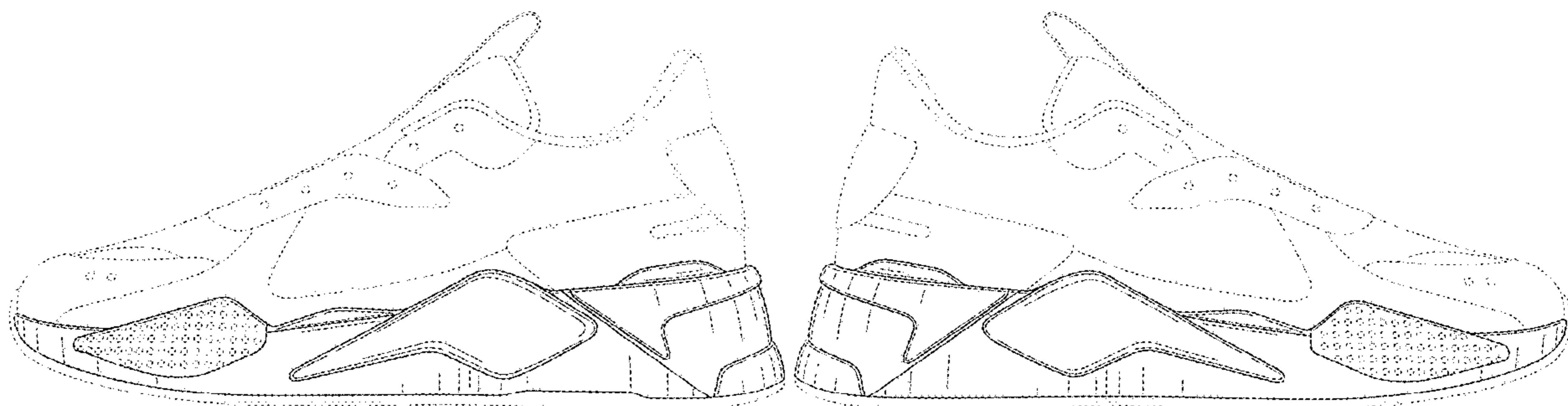

(56)

References Cited

U.S. PATENT DOCUMENTS

D337,871 S \* 8/1993 Teague ..... D2/977  
 D339,674 S \* 9/1993 Avar ..... D2/977  
 D341,700 S \* 11/1993 Avar ..... D2/977  
 D341,932 S \* 12/1993 Elliot ..... D2/977  
 D342,377 S \* 12/1993 Smith ..... D2/955  
 D347,318 S \* 5/1994 Avar ..... D2/947  
 D356,884 S \* 4/1995 Ho ..... D2/902  
 D401,039 S \* 11/1998 Lupo ..... D2/947  
 5,926,974 A \* 7/1999 Friton ..... A43B 13/20  
 36/28  
 D515,305 S \* 2/2006 Andrews-Kramer ..... D2/947  
 D515,306 S \* 2/2006 Andrews-Kramer ..... D2/947  
 D594,195 S \* 6/2009 Nakano ..... D2/951  
 D623,386 S \* 9/2010 Nelson ..... D2/946  
 D625,494 S \* 10/2010 Nelson ..... D2/946  
 D644,007 S \* 8/2011 Akhidime ..... D2/946  
 D648,514 S \* 11/2011 Avar ..... D2/946  
 D671,304 S \* 11/2012 Lacorazza ..... D2/951  
 D683,526 S \* 6/2013 Day, Jr. .... D2/902  
 D686,805 S \* 7/2013 Day, Jr. .... D2/902  
 D689,273 S \* 9/2013 Hardman ..... D2/947  
 D689,675 S \* 9/2013 Hardman ..... D2/947  
 D707,432 S \* 6/2014 Mochen ..... D2/951  
 D765,363 S \* 9/2016 Petrie ..... D2/947  
 D778,553 S \* 2/2017 DeAlmeida ..... D2/947  
 D783,246 S \* 4/2017 Chang ..... D2/947  
 D790,173 S \* 6/2017 Raasch ..... D2/947  
 D794,293 S \* 8/2017 Robusti ..... D2/954

D796,816 S \* 9/2017 Klein ..... D2/972  
 D802,266 S \* 11/2017 Hardman ..... A43B 5/1633  
 D2/947  
 D803,531 S \* 11/2017 Petrie ..... A43B 3/00  
 D2/947  
 D809,757 S \* 2/2018 Ford ..... D2/947  
 D813,506 S \* 3/2018 O'Connor ..... D2/947  
 D828,984 S \* 9/2018 Gibson ..... A43B 13/20  
 D2/947  
 D828,985 S \* 9/2018 Gibson ..... D2/947  
 D829,423 S \* 10/2018 Robusti ..... D2/947  
 D844,952 S \* 4/2019 Taylor ..... D2/947  
 D845,594 S \* 4/2019 Popovic ..... D2/947  
 D846,241 S \* 4/2019 Enayah ..... D2/947  
 D851,875 S \* 6/2019 Jacobs ..... D2/947  
 D853,690 S \* 7/2019 Taylor ..... D2/908  
 D856,649 S \* 8/2019 Small ..... D2/947  
 D858,946 S \* 9/2019 Eugene ..... D2/896  
 D862,054 S \* 10/2019 Chang ..... D2/947  
 D864,548 S \* 10/2019 Matthews ..... D2/972  
 D866,134 S \* 11/2019 McMillan ..... D2/947  
 2009/0200763 A1 \* 8/2009 Adams ..... A43B 5/1633  
 280/11.19  
 2010/0180474 A1 \* 7/2010 Clark ..... A43B 3/00  
 36/3 B  
 2013/0291404 A1 \* 11/2013 Follows ..... A43B 13/20  
 36/105  
 2018/0092431 A1 \* 4/2018 Iuchi ..... A43B 13/14  
 2019/0082781 A1 \* 3/2019 Iuchi ..... A43B 13/04

\* cited by examiner

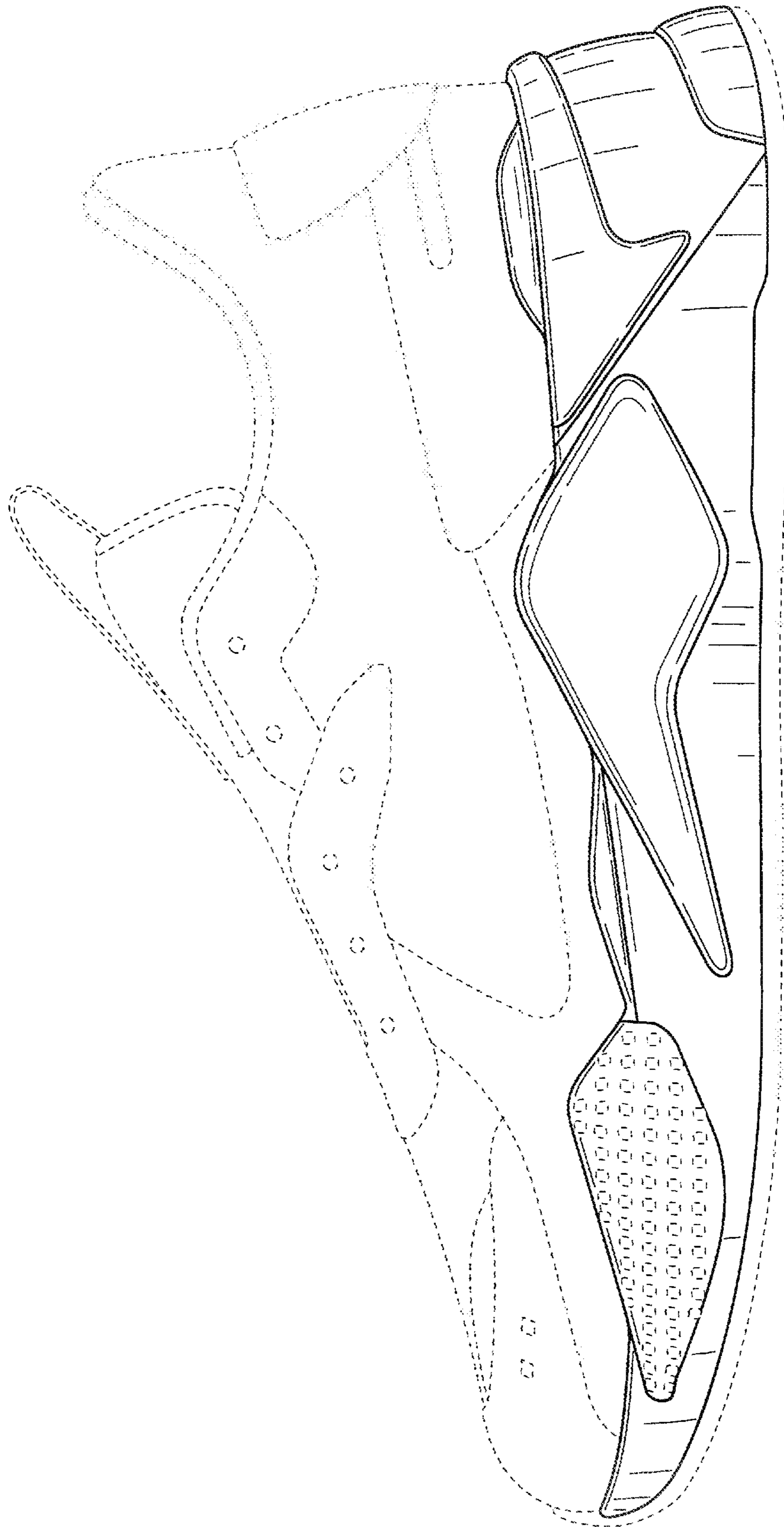

FIG. 1

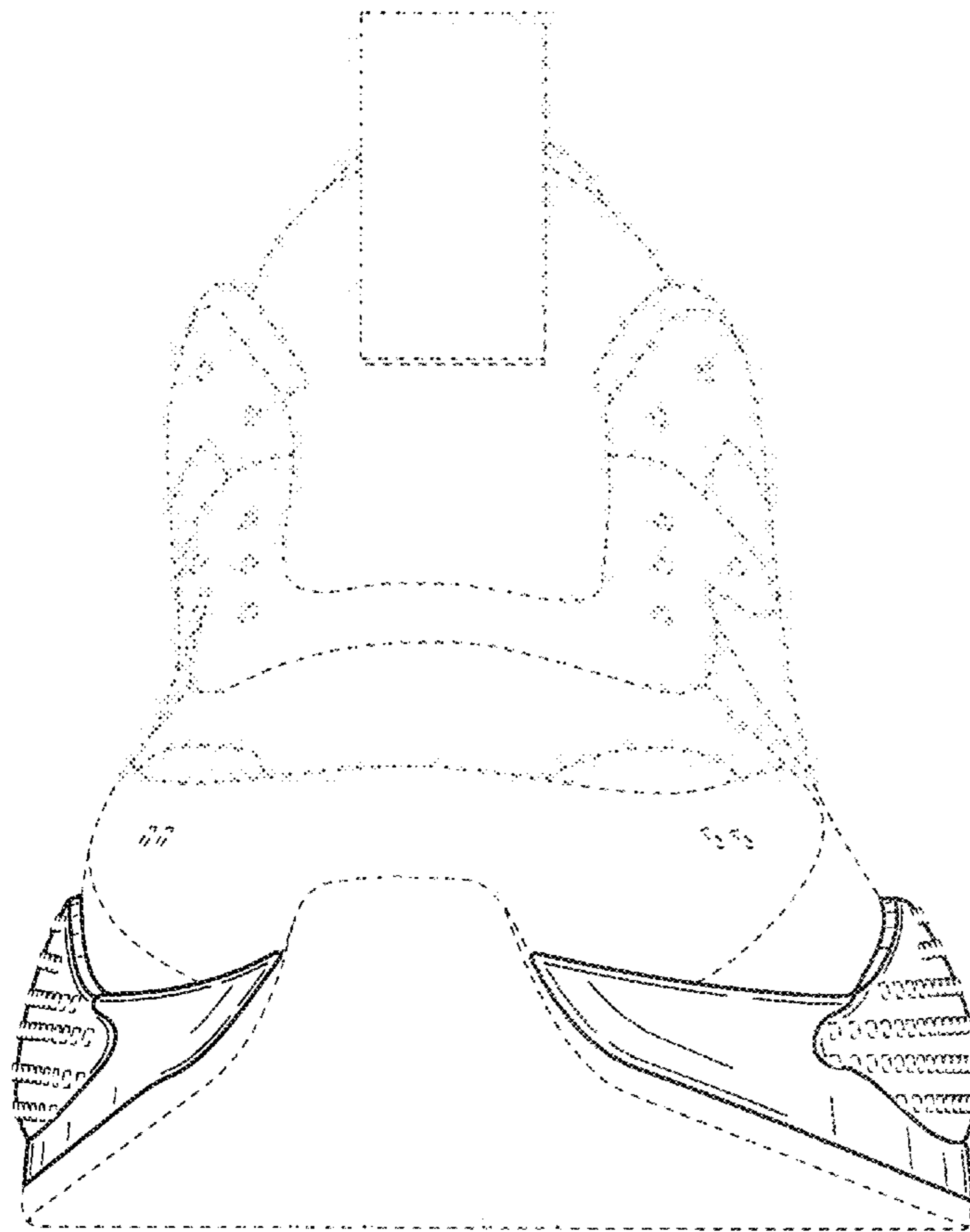

FIG. 2

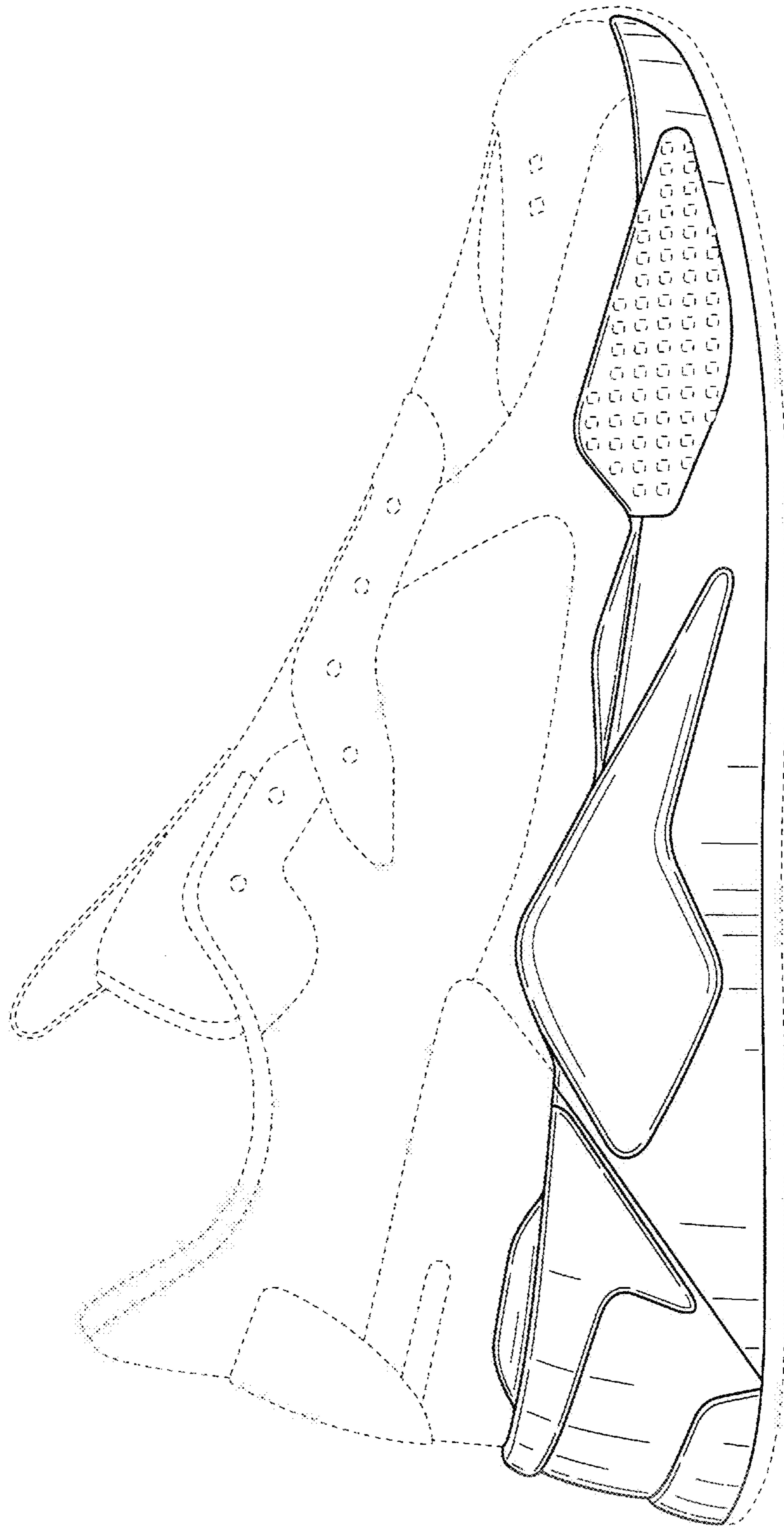

FIG. 3

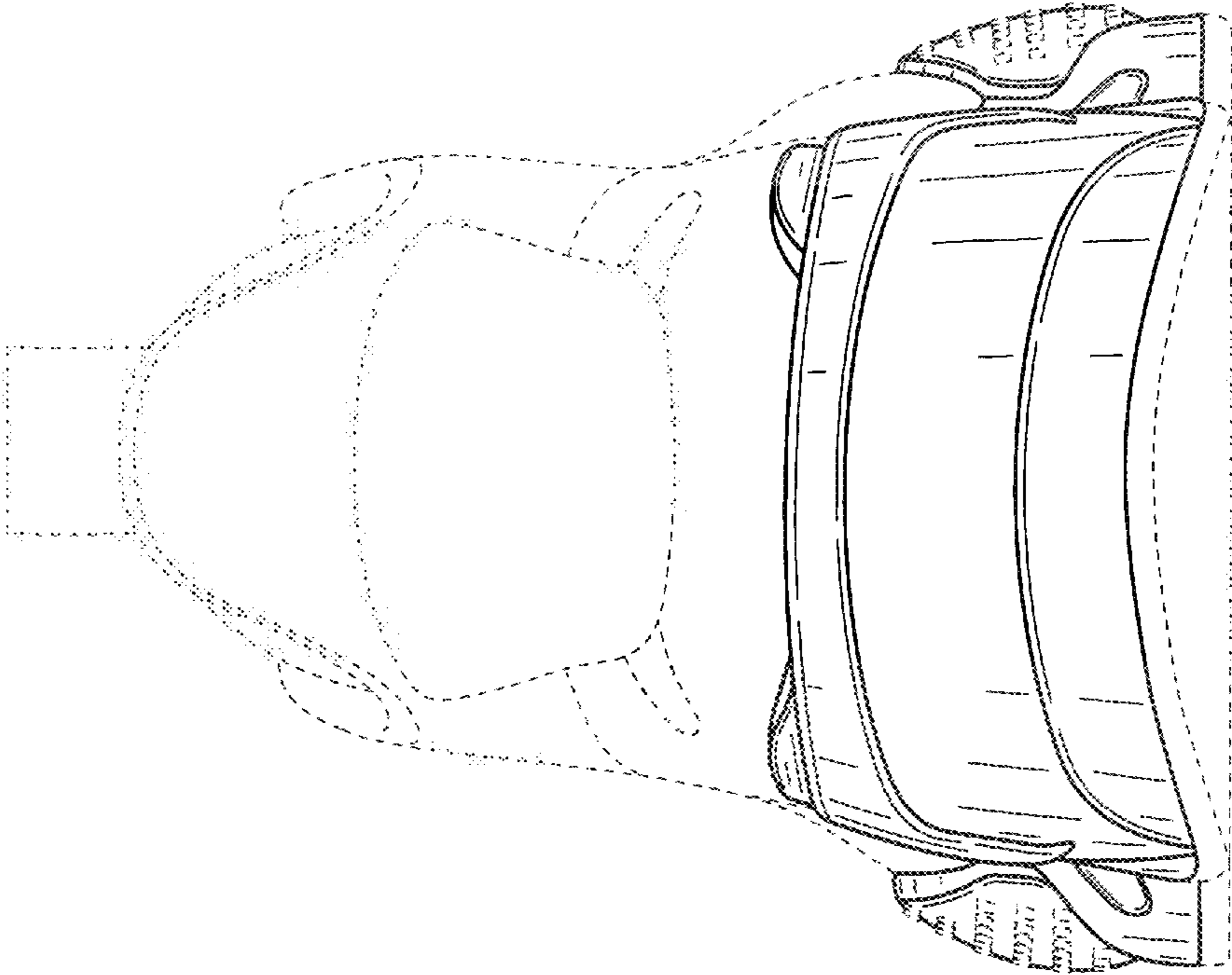

FIG. 4

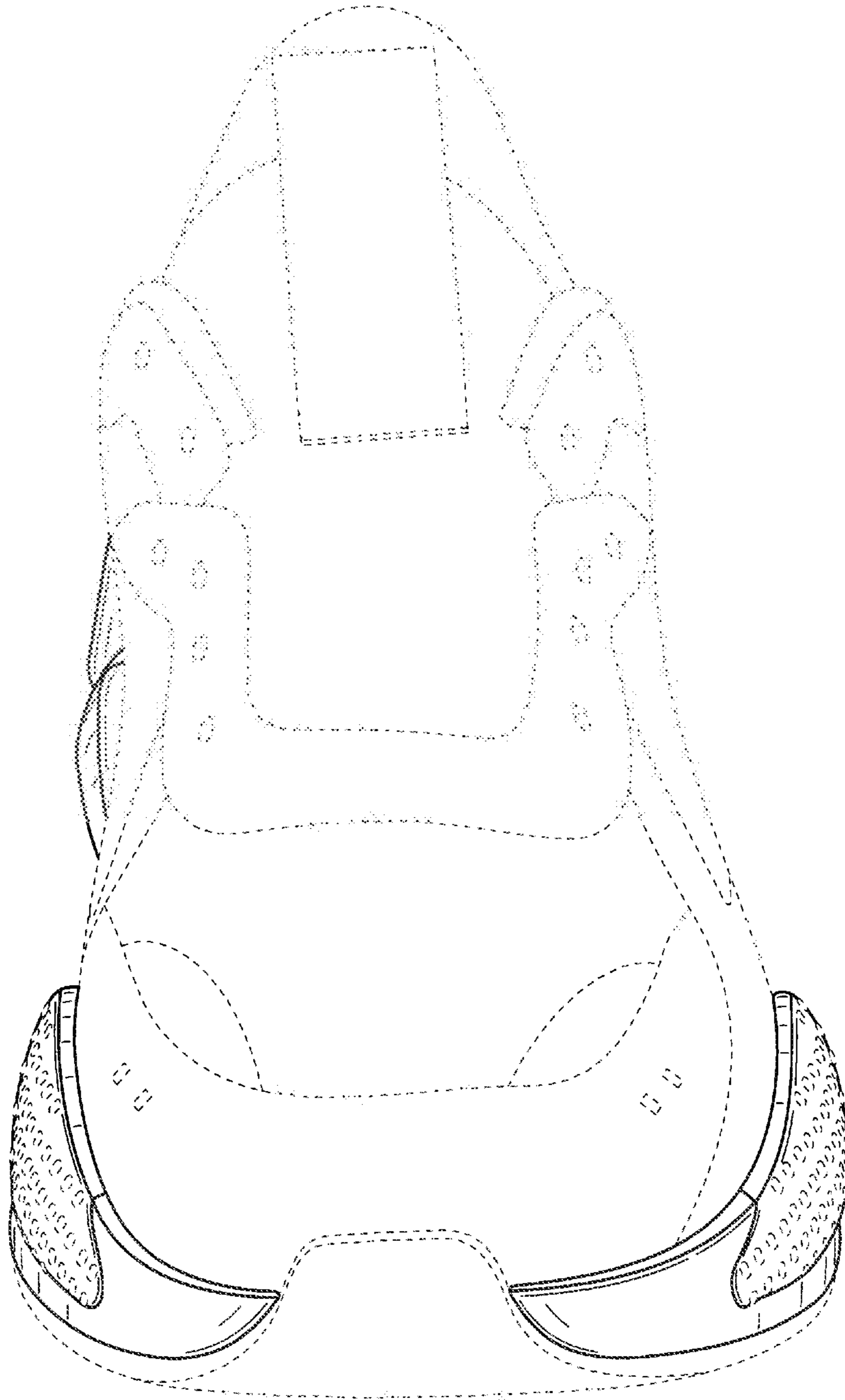

FIG. 5

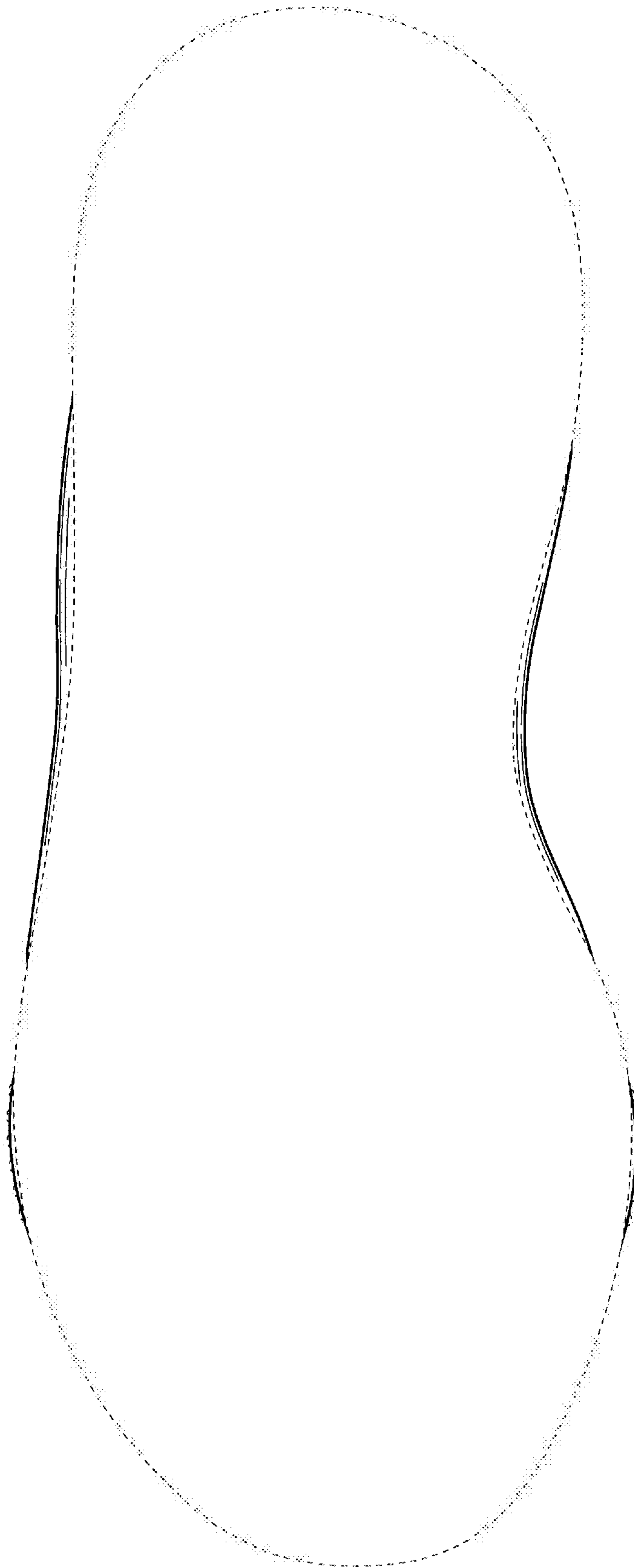

FIG. 6



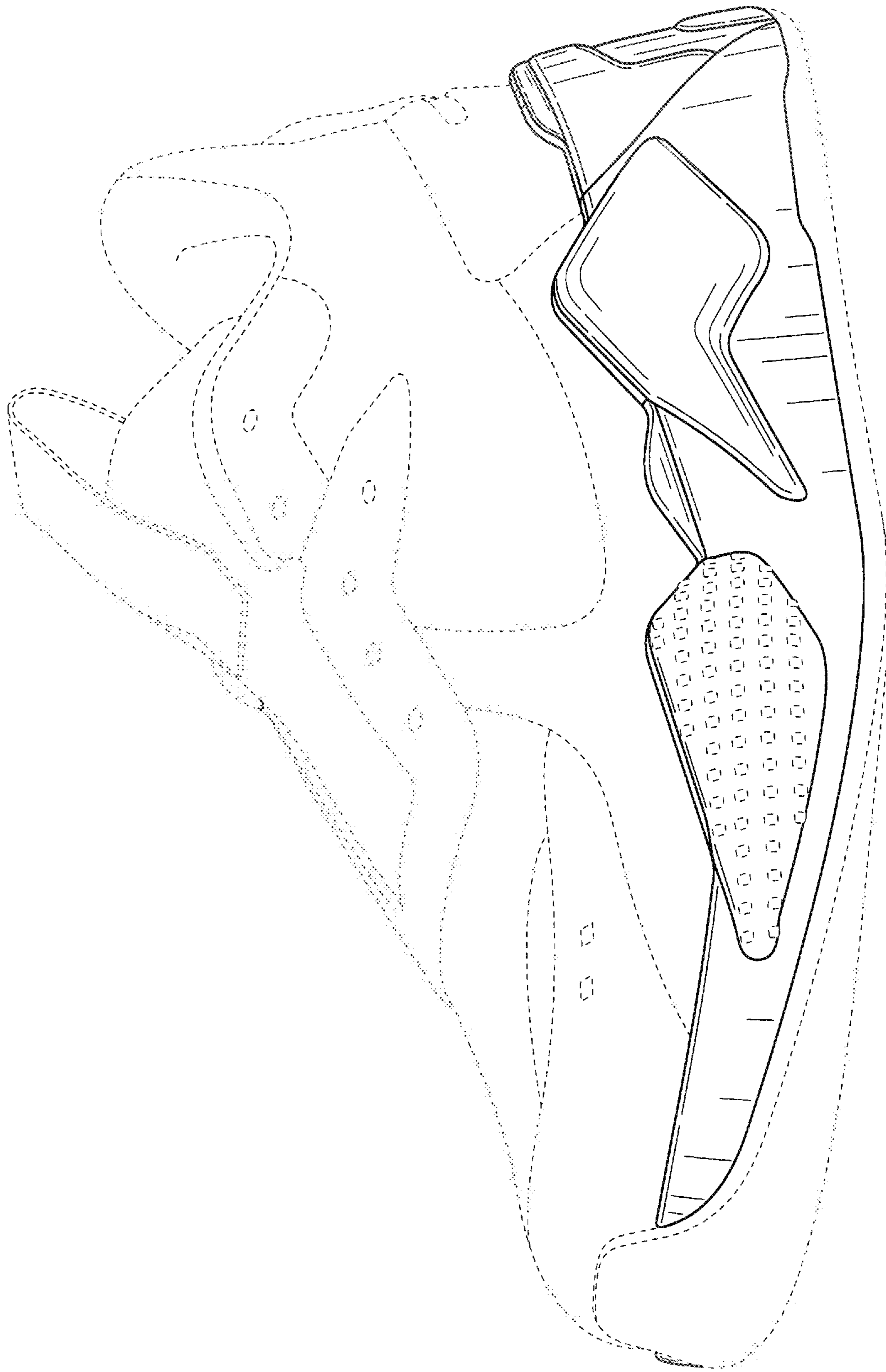

FIG. 7

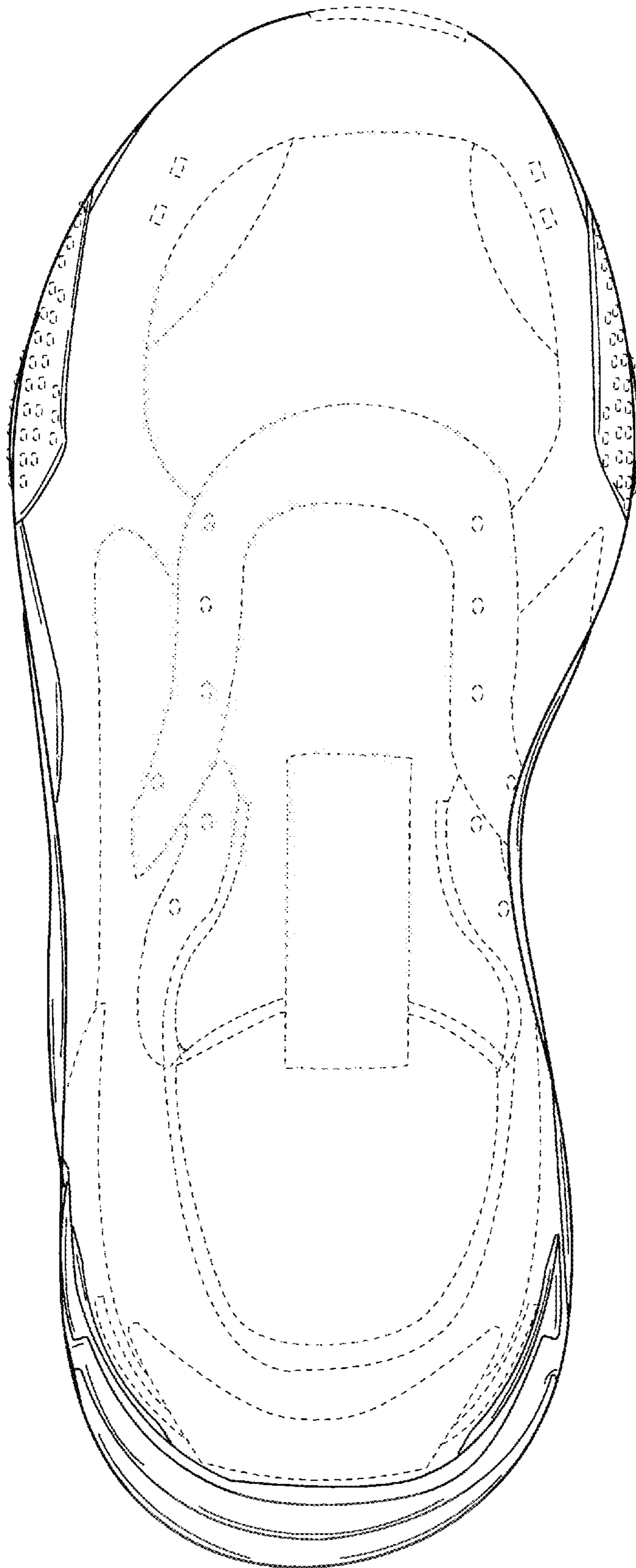

FIG. 8