



US00D877348S

(12) **United States Design Patent** (10) **Patent No.:** **US D877,348 S**
Barber et al. (45) **Date of Patent:** **** Mar. 3, 2020**

- (54) **HEEL POSITIONER**
- (71) Applicant: **Ansell Limited**, Richmond, Victoria (AU)
- (72) Inventors: **Jennifer Barber**, Simi Valley, CA (US); **Adam Weintraub**, Calabasas, CA (US); **Noel Muldowney**, County Kildare (IE); **Michael Lawler**, County Kildare (IE)
- (73) Assignee: **Ansell Limited**, Victoria (AU)
- (**) Term: **15 Years**
- (21) Appl. No.: **29/597,881**
- (22) Filed: **Mar. 21, 2017**
- (51) **LOC (12) Cl.** **24-01**
- (52) **U.S. Cl.**
USPC **D24/192**
- (58) **Field of Classification Search**
USPC D2/641-643, 979, 999; D3/200; D20/27; D24/136, 184, 192; D28/91.2; D32/46; D7/688; D8/19, 45; D11/221
CPC A47G 25/80; A47G 25/82; A47G 25/84; A47G 25/86; A47G 25/88; A47G 25/90; A47G 25/902; A47G 25/904; A47G 25/905; A47G 25/907; A47G 25/92; B44D 3/162; E04F 21/161; A43B 7/28; A61F 5/0111; A63C 10/22
See application file for complete search history.

- 4,186,738 A * 2/1980 Schleicher A61F 13/069 128/892
 - D339,671 S * 9/1993 Manning D2/896
 - 5,673,448 A * 10/1997 Lang A43B 5/0405 12/142 P
 - D399,968 S * 10/1998 Petersen D24/190
- (Continued)

OTHER PUBLICATIONS

“AliGel™ Heel Cup Gel Positioner”, AliMed, http://www.alimed.com/aligel-heel-cup.html?atrkid=V3ADWA342718F_20842381084_pla-124934680324_66599244004_g_c_pla_with_promotion_1o1&gclid=CMu2rcelytQCFQkpaQod674OVA.
(Continued)

Primary Examiner — Kevin K Rudzinski
Assistant Examiner — Clare Ann Gannon
(74) *Attorney, Agent, or Firm* — Moser Taboada

(57) **CLAIM**

The ornamental design for a heel positioner, as shown and described.

DESCRIPTION

FIG. 1 is a perspective view of a heel positioner embodying the new design;
FIG. 2 is a front plan view of the heel positioner embodying the new design;
FIG. 3 is a rear plan view of the heel positioner embodying the new design;
FIG. 4 is a left plan view of the heel positioner embodying the new design;
FIG. 5 is a right plan view of the heel positioner embodying the new design;
FIG. 6 is a top plan view of the heel positioner embodying the new design; and,
FIG. 7 is a bottom plan view of the heel positioner embodying the new design.
The broken lines represent portions of the heel positioner that forms no part of the claimed design.

1 Claim, 7 Drawing Sheets

(56) **References Cited**

U.S. PATENT DOCUMENTS

- 3,198,192 A * 8/1965 O'Brien A61F 5/0195 602/10
- D225,472 S * 12/1972 Loweery A47G 25/907 D24/192
- 3,721,237 A * 3/1973 Alessio A61F 13/069 128/892
- 3,929,140 A * 12/1975 Wesberg A43B 7/28 36/154

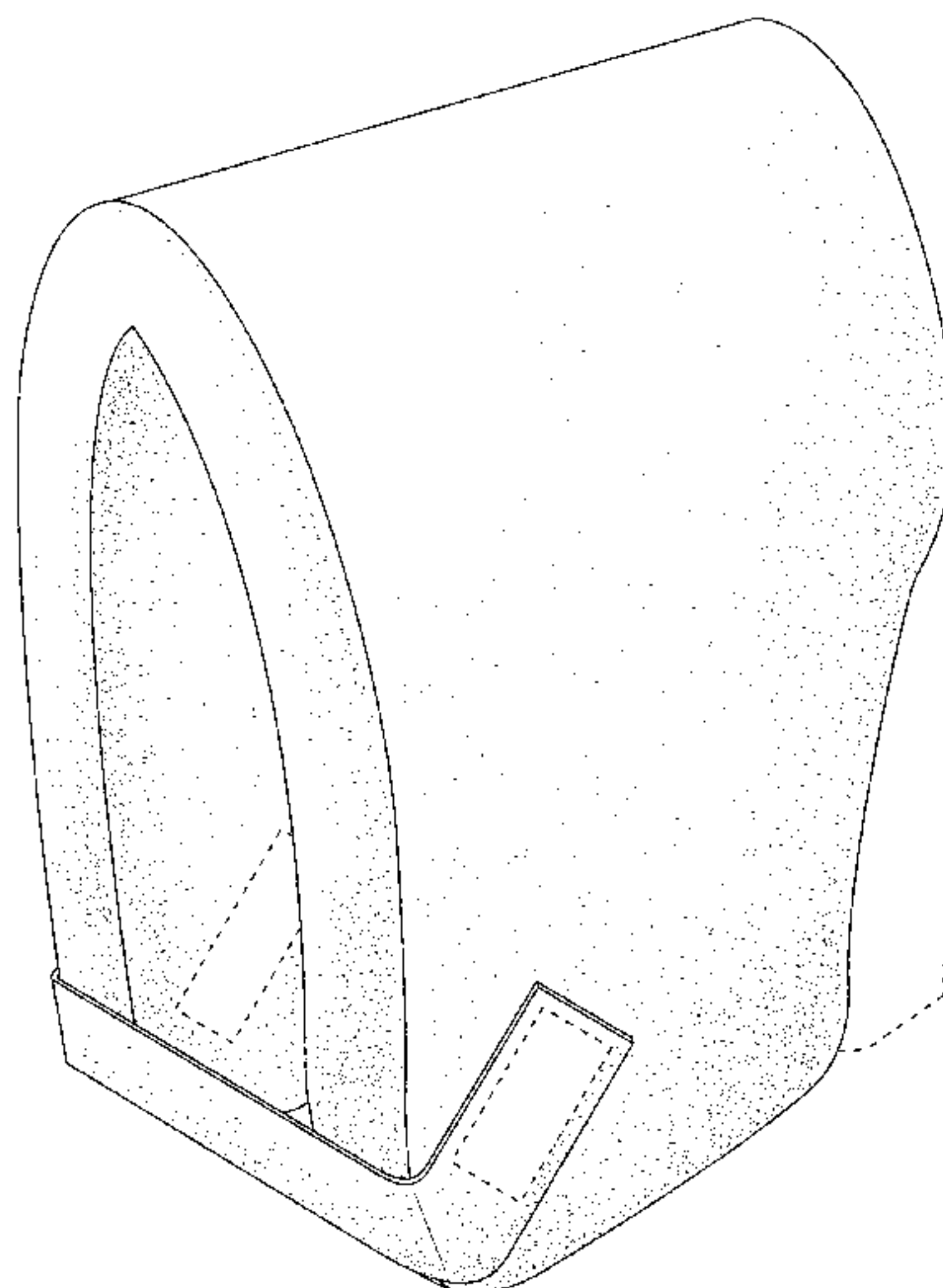

(56)

References Cited

U.S. PATENT DOCUMENTS

D454,200 S * 3/2002 Lamping D24/192
 6,575,490 B1 6/2003 Laughlin
 D553,251 S * 10/2007 Watts D24/192
 D571,083 S * 6/2008 Mohammad D2/900
 D578,652 S * 10/2008 Tabron D24/192
 7,455,651 B2 * 11/2008 Mollica A61F 13/066
 128/845
 D618,889 S * 7/2010 Jones D2/909
 D639,443 S * 6/2011 McPike A61F 5/0111
 D24/192
 D697,628 S * 1/2014 Drey D24/192
 D702,359 S * 4/2014 Amiot A61F 13/066
 D24/192
 D728,903 S * 5/2015 Turman D2/903
 9,827,131 B2 * 11/2017 Watts A61F 5/0111
 2010/0089954 A1 * 4/2010 Rondeau A47G 25/907
 223/111
 2010/0121245 A1 * 5/2010 Marino A47G 25/907
 602/75
 2010/0152638 A1 * 6/2010 Ponsi A61F 5/0111
 602/23
 2014/0075781 A1 * 3/2014 Davis A61F 5/0585
 36/88
 2014/0316321 A1 * 10/2014 Mueller A61F 5/0111
 602/27

OTHER PUBLICATIONS

“Heel and Elbow Protector”, Medicus Health, <http://www.medicus-health.com/heel-and-elbow-protector.aspx?gclid=CKbGwNClytQCFQkEaQodovkBcw>.
 “Medline NonSlip Heel Protectors; Pair”, Quill.Com, https://www.quill.com/medline-non-slip-heel-protectors-pair/cbs/295530.html?hidedisruptive=1&cm_mmc=SEM_PLA_NULL_295530&mcode=SEM_PLA_NULL_295530&gclid=COXqx9WlytQCFZC2wAod5ScEgA&gclsrc=aw.ds.
 “Medline Heelmedix Heel Protector, 1ct”, Walmart, <https://www.walmart.com/ip/Medline-Heelmedix-Heel-Protector-1ct/16608861?wmlspartner=wlpa&adid=2222222227010199924&wl0=&wl1=g&wl2=c&wl3=40754292992&wl4=pla-78606695072&wl5=9003541&wl6=&wl7=&wl8=&wl9=pla&wl10=8175035&wl11=online&wl12=16608861&wl13=&veh=sem>.

* cited by examiner

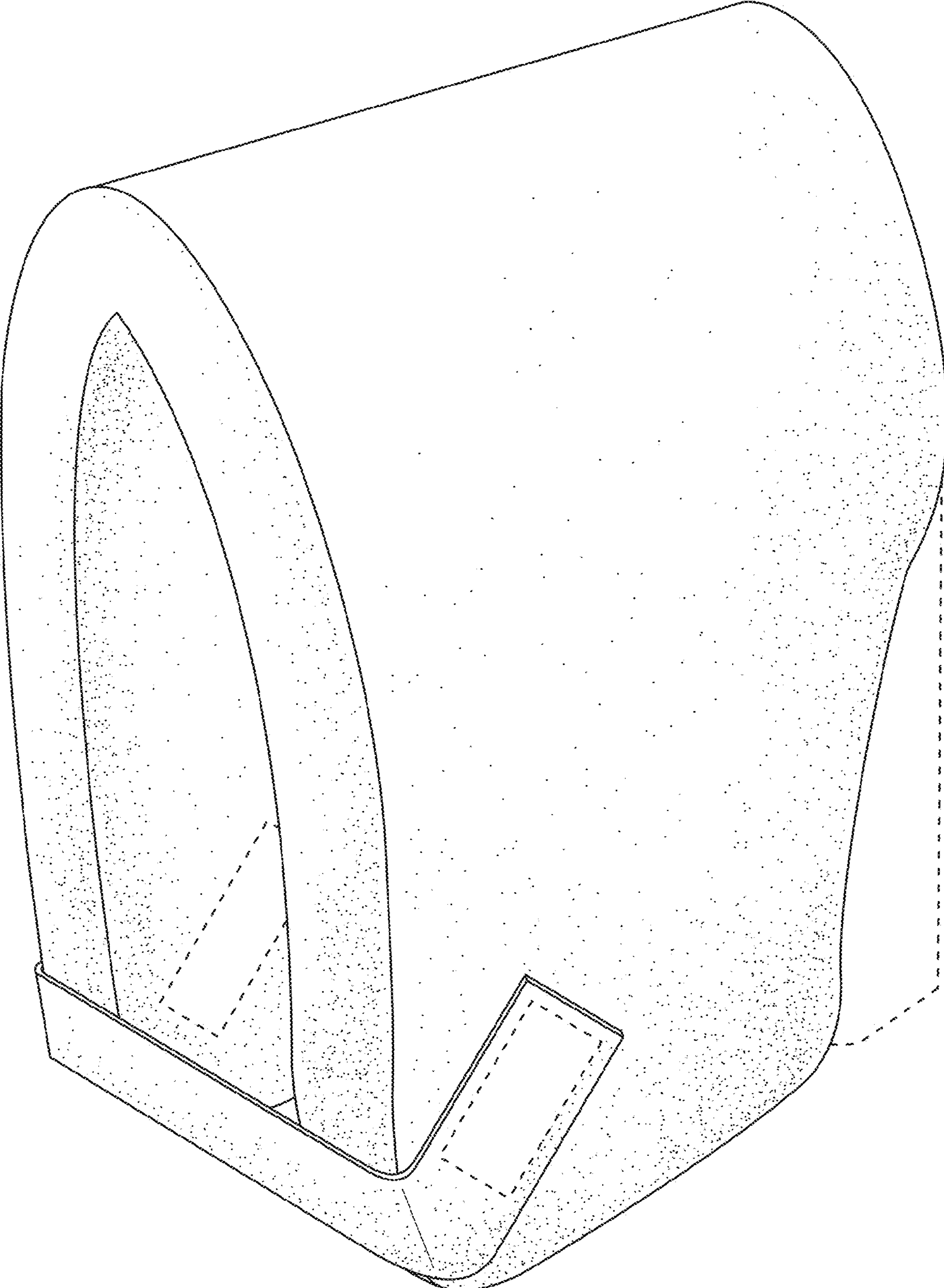

FIG. 1

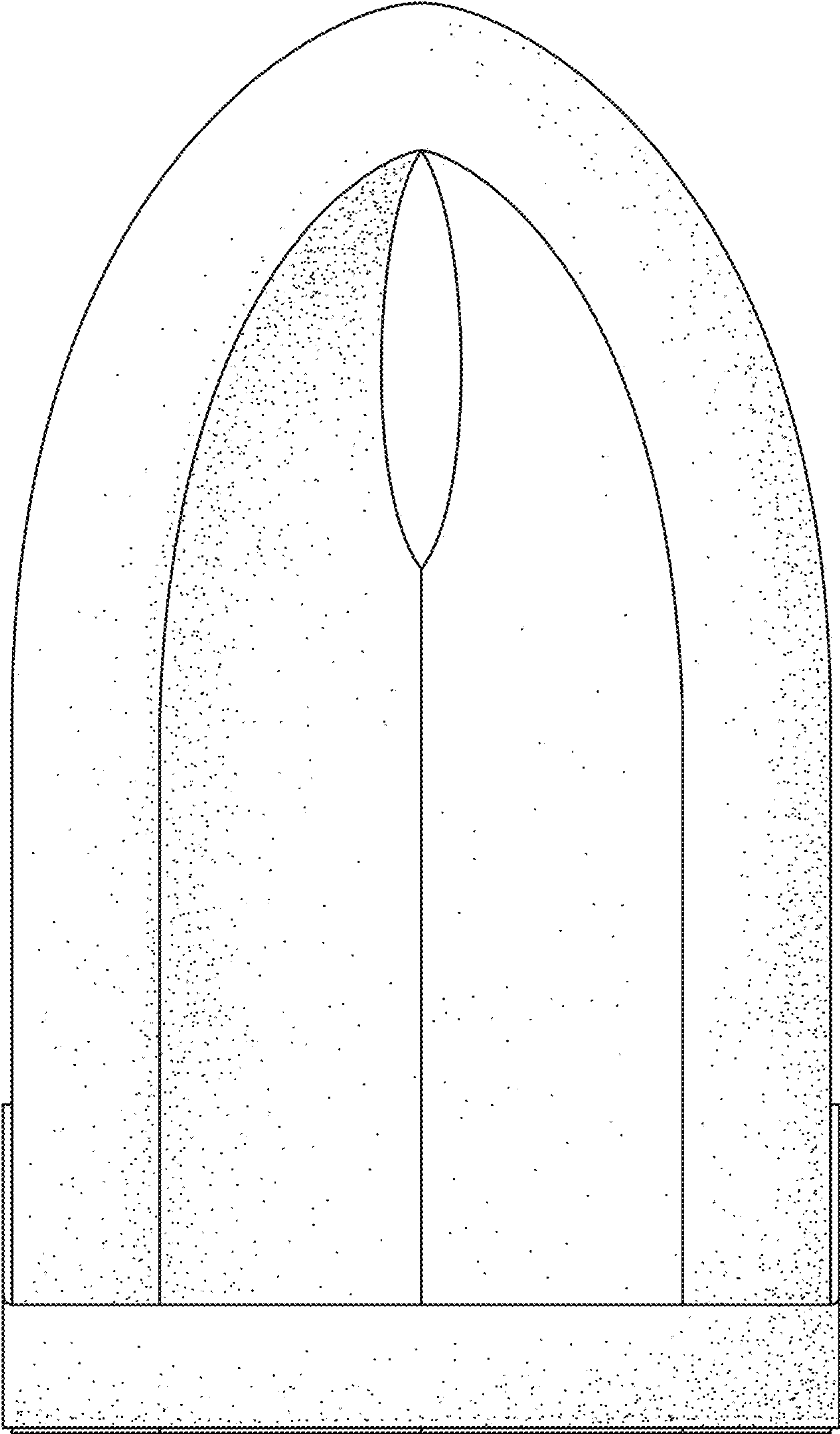

FIG. 2

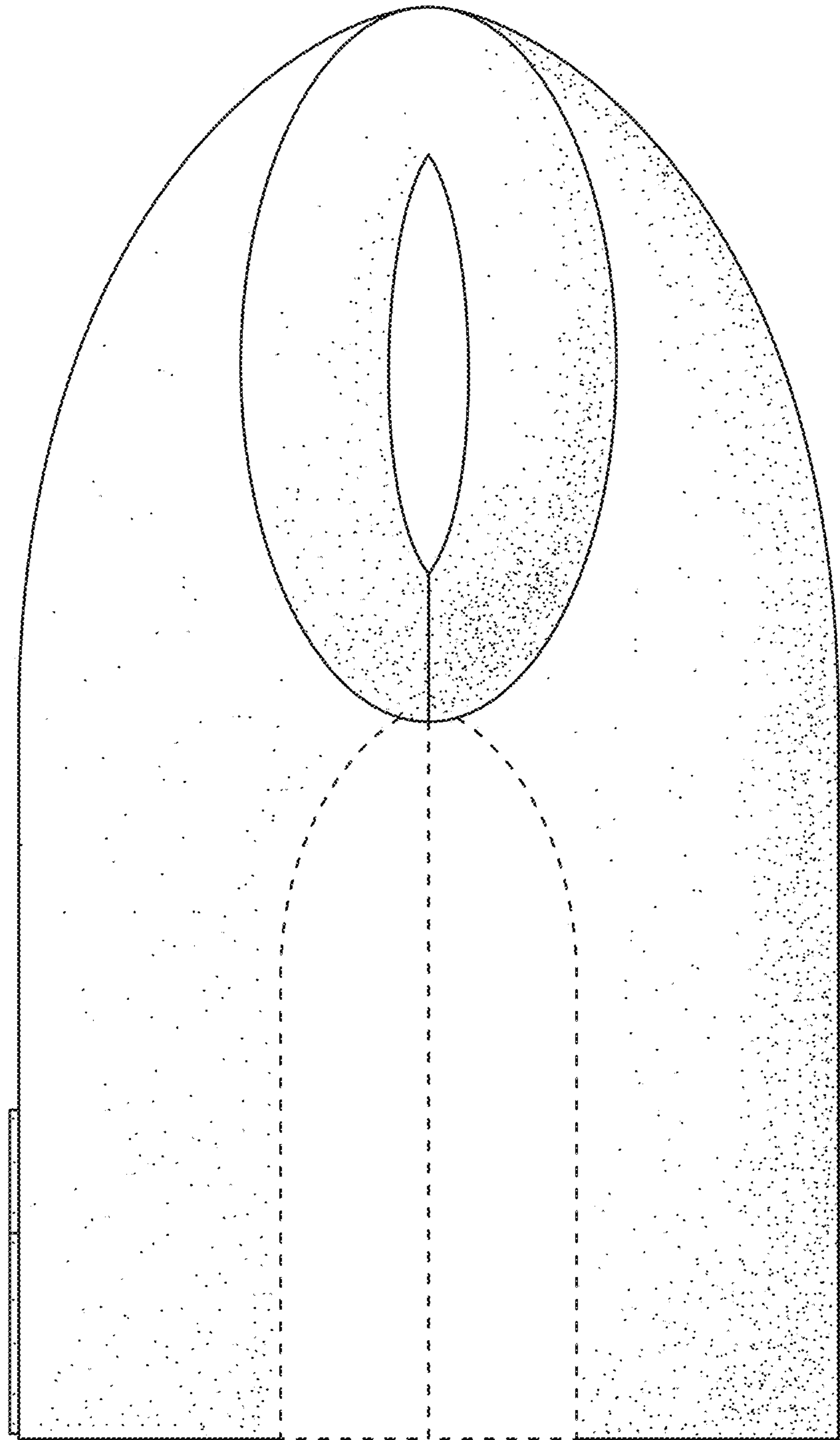

FIG. 3

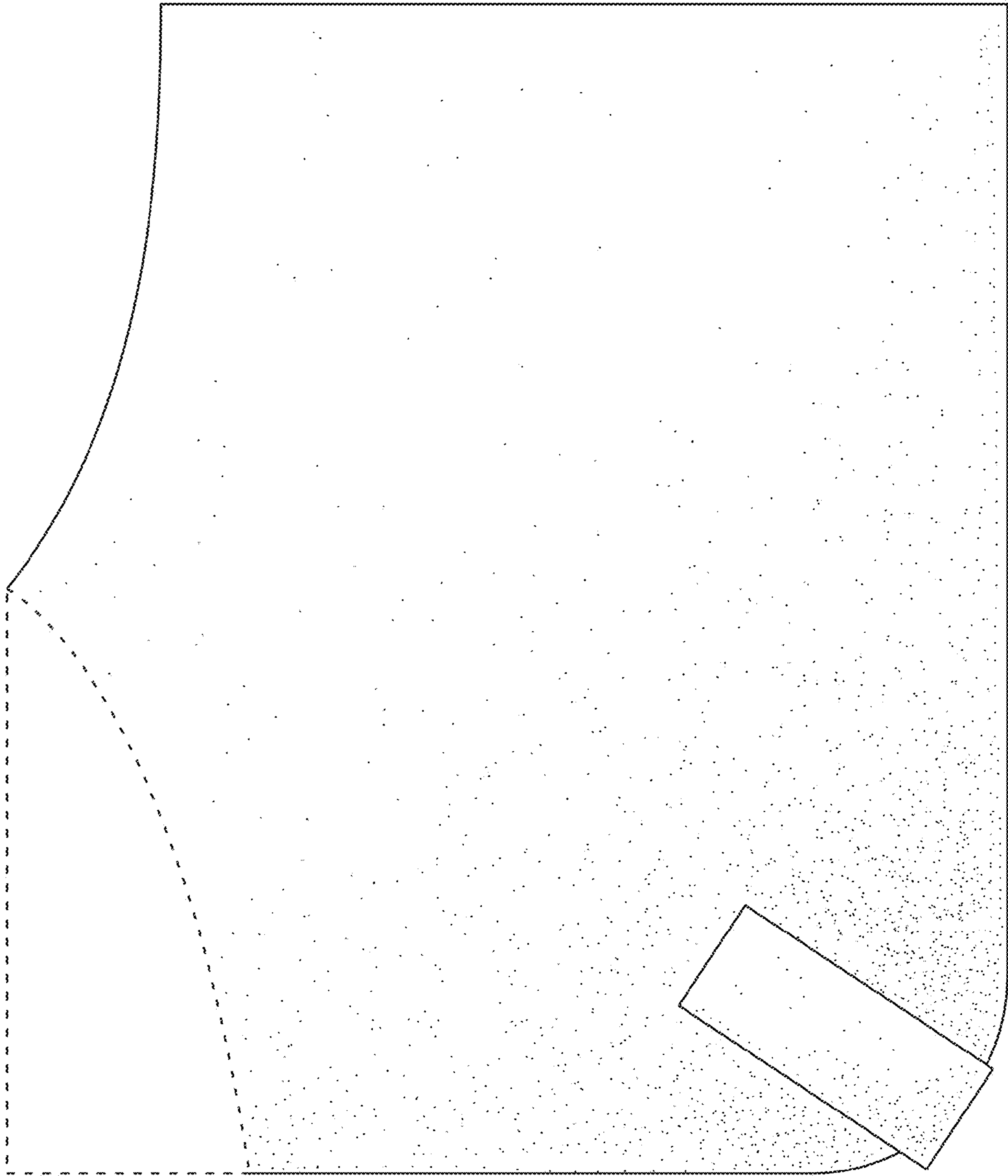

FIG. 4

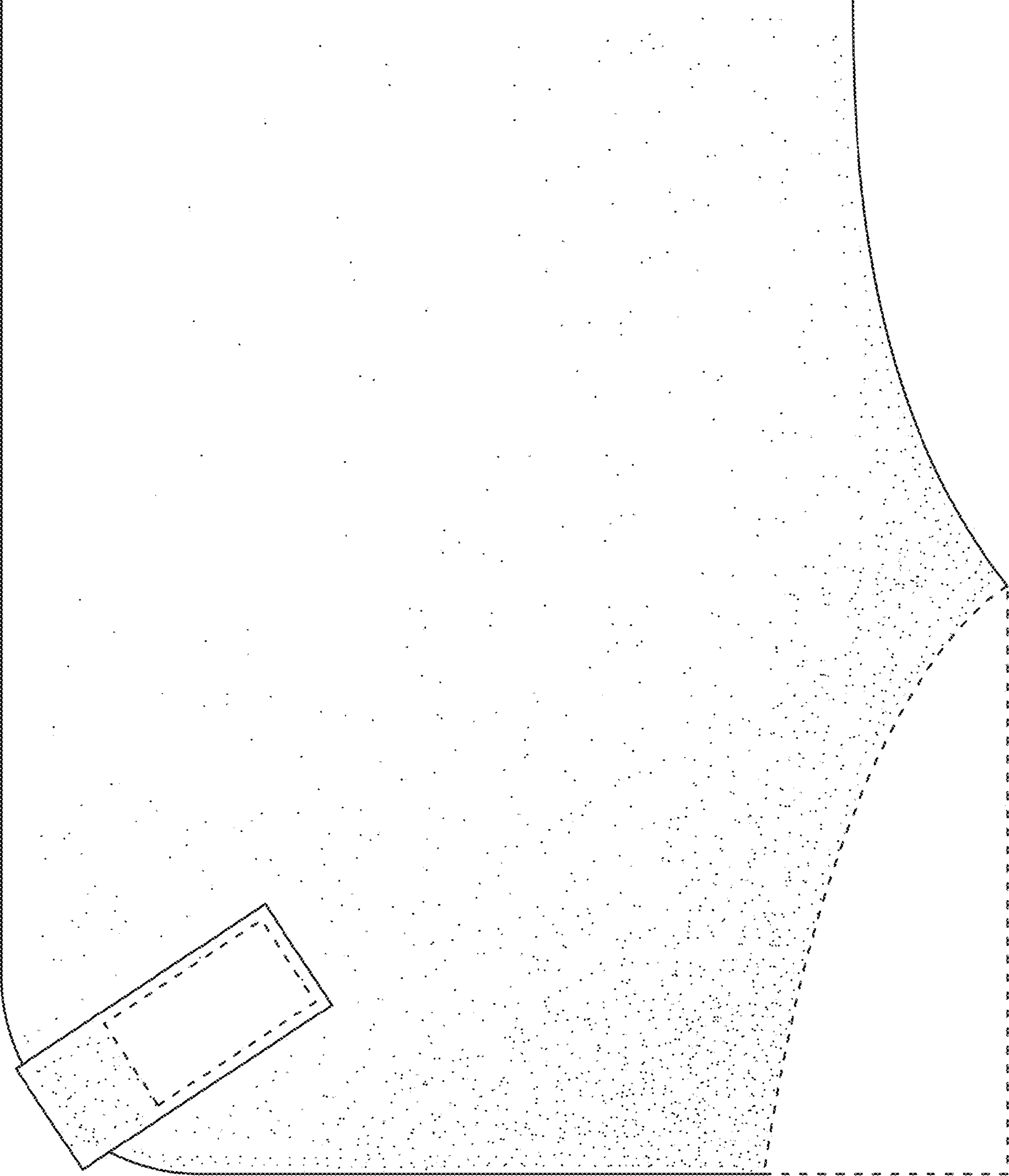

FIG. 5

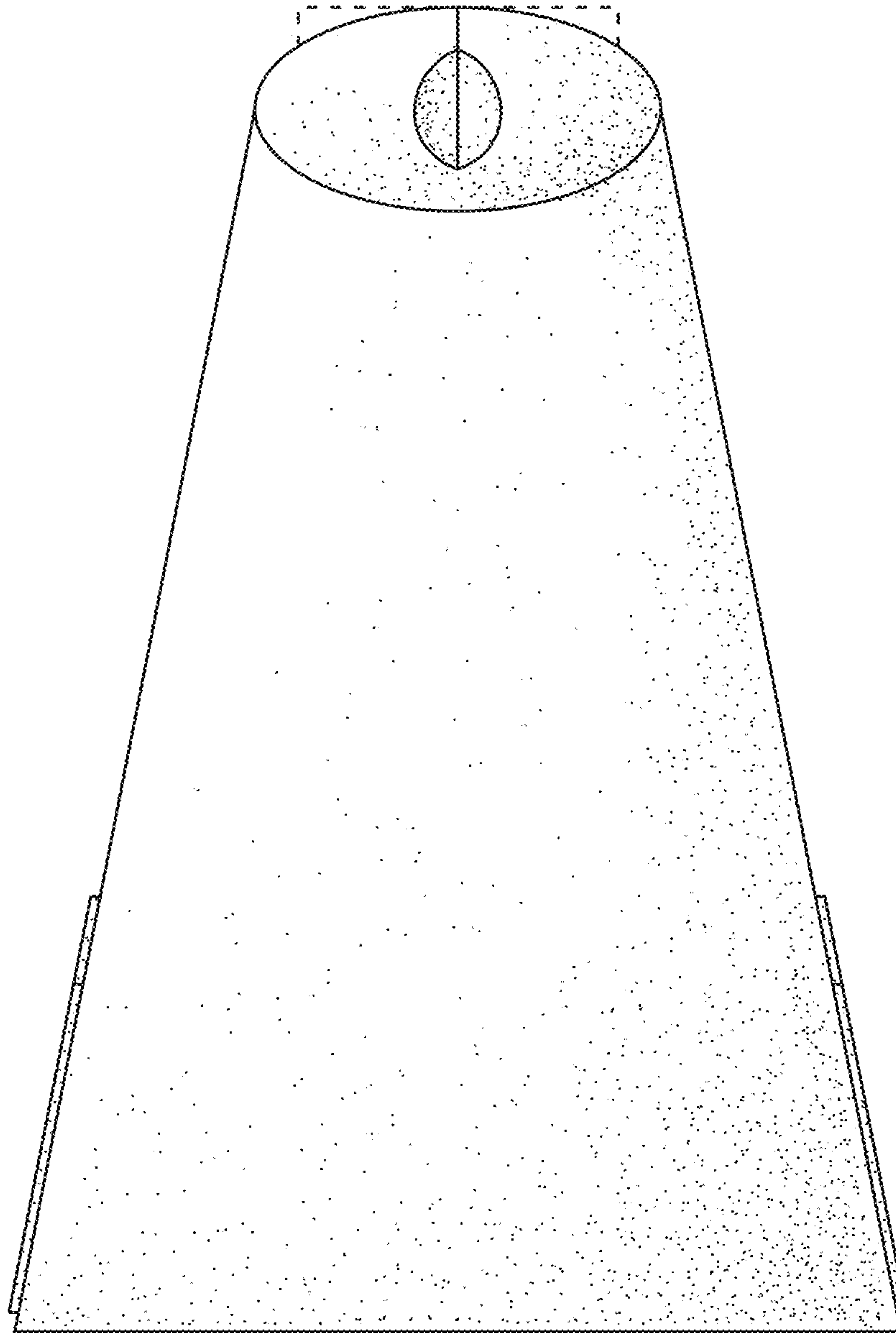

FIG. 6

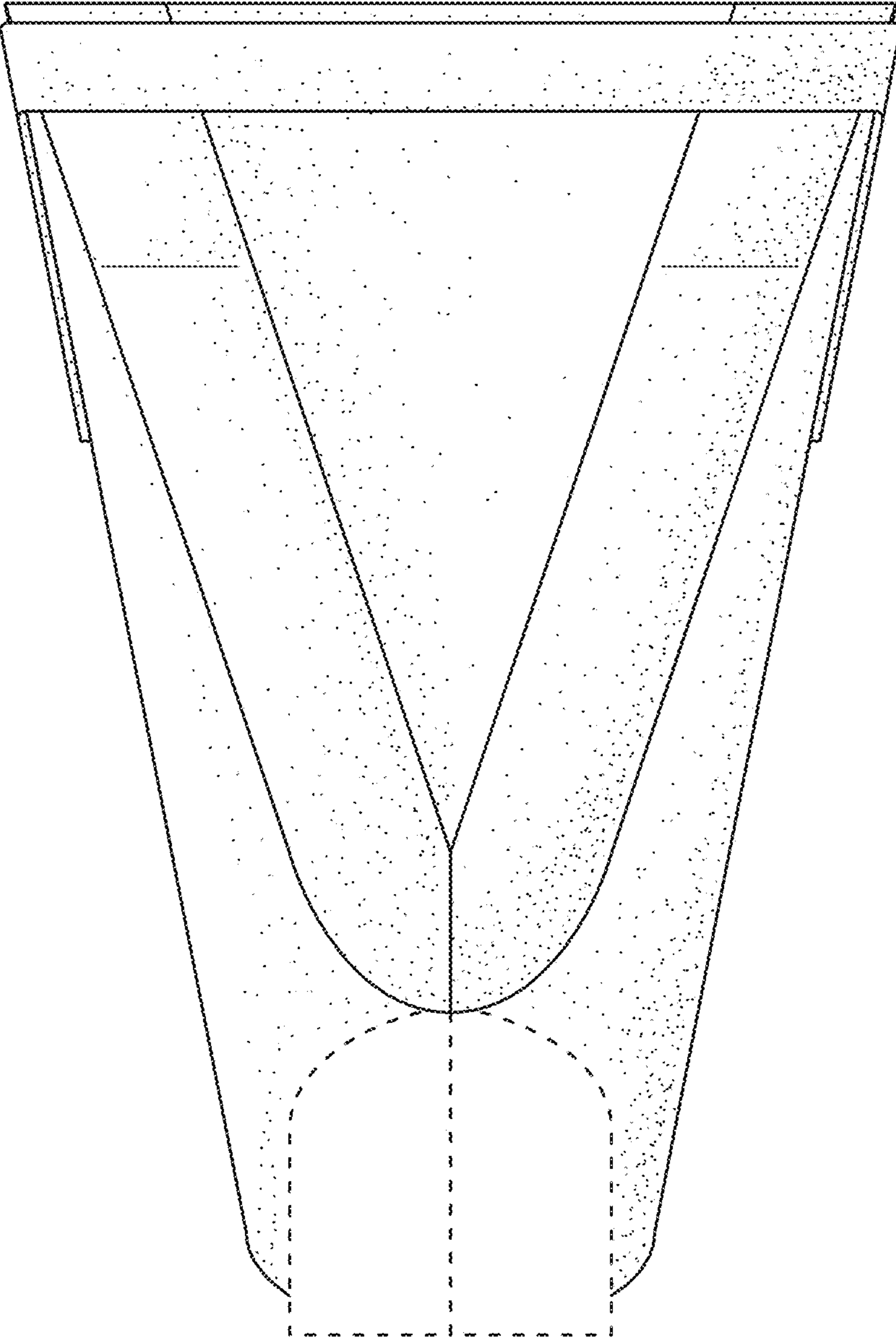

FIG. 7