



US00D877136S

(12) **United States Design Patent**  
**Lee**

(10) **Patent No.:** **US D877,136 S**  
(45) **Date of Patent:** **\*\* Mar. 3, 2020**

(54) **CASE FOR ELECTRONIC COMMUNICATIONS DEVICE**

(71) Applicant: **SPIGEN KOREA CO., LTD.**, Seoul (KR)

(72) Inventor: **Jong Hwa Lee**, Seoul (KR)

(73) Assignee: **Spigen Korea CO., LTD.**, Seoul (KR)

(\*\*) Term: **15 Years**

(21) Appl. No.: **29/681,409**

(22) Filed: **Feb. 25, 2019**

(51) **LOC (12) Cl.** ..... **14-03**

(52) **U.S. Cl.**  
USPC ..... **D14/250**

(58) **Field of Classification Search**

USPC ..... D3/201, 218, 226, 227, 247, 249, 250,  
D3/269, 303; D13/103, 107, 108, 119;  
D14/137, 138 R, 138 AA, 138 C, 138 G,  
D14/172, 192, 203.3–203.7, 217, 238.1,  
D14/247, 248, 250–253, 434, 440, 447,  
D14/496

CPC ..... H04B 1/3888; H04M 1/0283; H04M  
1/0202; A45C 1/06; A45C 2011/002;  
A45C 11/00; A45F 2005/028; A45F  
2200/0525

See application file for complete search history.

(56) **References Cited**

**U.S. PATENT DOCUMENTS**

6,758,335 B2 7/2004 Kajiya  
D517,545 S 3/2006 Buckel et al.  
(Continued)

**OTHER PUBLICATIONS**

This is what folding phone cases will look like, Spigen reveals its first models, publication date Mar. 1, 2019, [online][site visited Jun.

12, 2019] URL: <https://www.theverge.com/2019/3/1/18246183/samsung-galaxy-fold-foladable-phone-case-screen-protector-spigen-zagg> (Year: 2019).\*

(Continued)

*Primary Examiner* — Susan E Krakower

*Assistant Examiner* — L. A. Grabenstetter

(74) *Attorney, Agent, or Firm* — Heedong Chae; Lucem, PC

(57) **CLAIM**

The ornamental design for a case for electronic communications device, as shown and described.

**DESCRIPTION**

FIG. 1 is a front perspective view of a case for electronic communications device in an open position showing my new design;

FIG. 2 is a rear perspective view thereof;

FIG. 3 is a front elevational view thereof;

FIG. 4 is a rear elevational view thereof;

FIG. 5 is a left side elevational view thereof;

FIG. 6 is a right side elevational view thereof;

FIG. 7 is a top plan view thereof;

FIG. 8 is a bottom plan view thereof;

FIG. 9 is a front perspective view thereof in a closed position, shown in an environment of use;

FIG. 10 is a rear perspective view thereof in a closed position, shown in an environment of use;

FIG. 11 is a front perspective view thereof in an open position, shown in an environment of use;

FIG. 12 is a rear perspective view thereof in an open position, shown in an environment of use; and,

FIG. 13 is an enlarged detail view of the encircled region of FIG. 1.

The dot-dash broken line circle in FIGS. 1 and 13 delineates a portion of the case that is part of the claimed design and that is shown on an enlarged scale in FIG. 13. The dashed broken lines depict an environmental foldable electronic communications device and portions of the case that form no part of the claimed design.

**1 Claim, 13 Drawing Sheets**

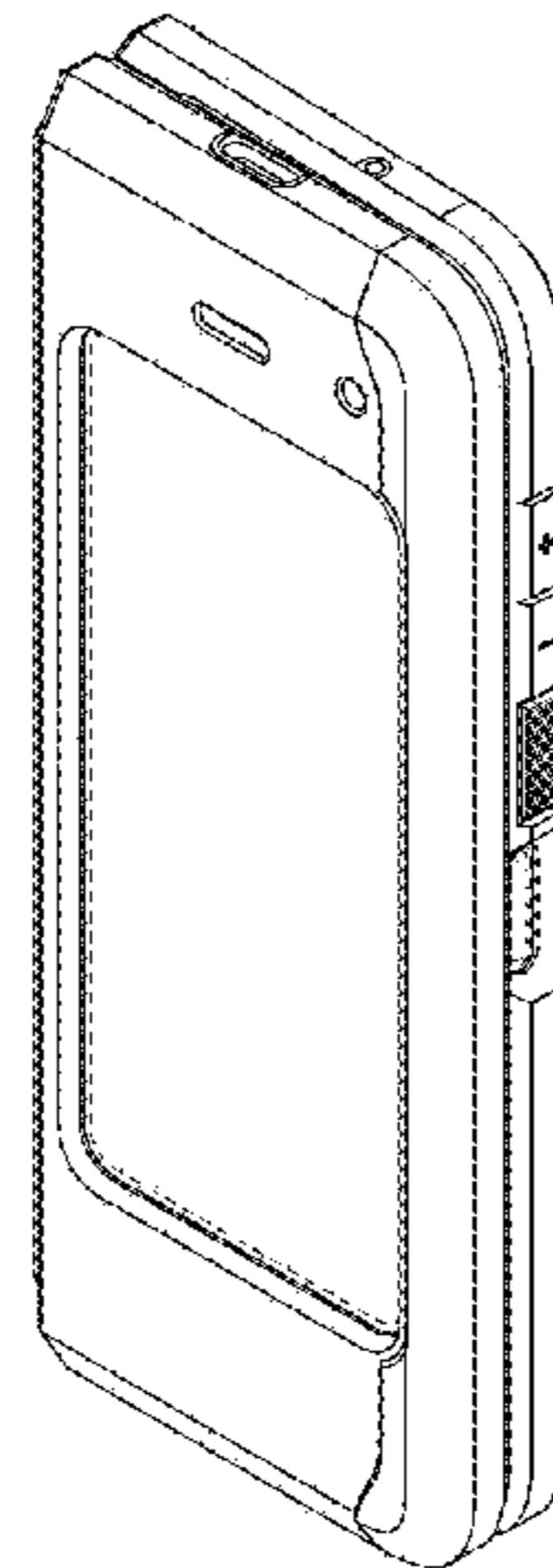
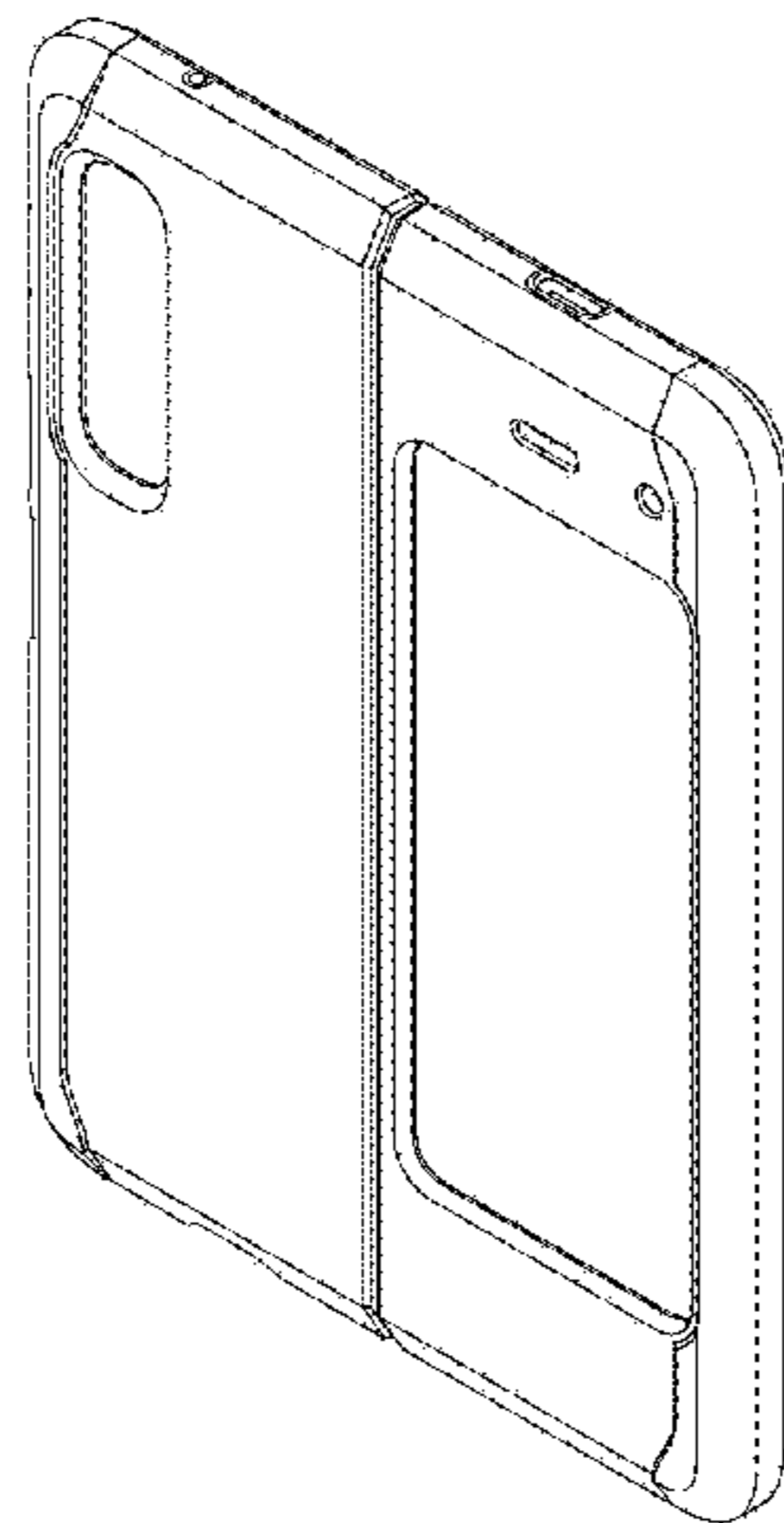

(56)

References Cited

U.S. PATENT DOCUMENTS

D524,806 S 7/2006 Eguchi  
 D551,846 S 10/2007 Ko et al.  
 D559,843 S 1/2008 Takamori et al.  
 D560,216 S 1/2008 Takamori et al.  
 D613,761 S 4/2010 Jones  
 D613,762 S 4/2010 Jones  
 D613,763 S 4/2010 Jones  
 D614,668 S 4/2010 Jones  
 D619,361 S 7/2010 Andre  
 D624,908 S 10/2010 Huskinson  
 D636,387 S 4/2011 Willes  
 D637,589 S 5/2011 Willes et al.  
 D646,265 S 10/2011 Fathollahi  
 D657,354 S 4/2012 Kim  
 D663,294 S 7/2012 Buxton  
 D673,547 S 1/2013 Melanson et al.  
 D676,035 S 2/2013 Chang  
 D679,271 S 4/2013 Liu  
 D681,615 S 5/2013 Fathollahi  
 D681,620 S \* 5/2013 Huskinson ..... D14/250  
 8,517,172 B1 8/2013 Chang  
 D696,256 S 12/2013 Piedra et al.  
 D702,673 S \* 4/2014 Murchison ..... D14/250  
 8,706,176 B1 4/2014 Jia  
 D705,534 S \* 5/2014 Manjerico ..... D3/218  
 D706,254 S 6/2014 Chang  
 D707,670 S 6/2014 Chang et al.  
 D709,871 S 7/2014 Lee  
 D718,758 S 12/2014 Jaffee  
 D721,071 S 1/2015 Nelson  
 D729,812 S \* 5/2015 Ahn ..... D14/440  
 D733,111 S 6/2015 Kim  
 9,049,283 B1 6/2015 Kim  
 D733,714 S 7/2015 Ballou et al.  
 9,077,436 B1 \* 7/2015 Liu ..... H04B 1/3888  
 9,185,954 B2 11/2015 Cheung  
 D744,491 S \* 12/2015 Lee ..... D14/440  
 D745,013 S \* 12/2015 Brierley ..... D14/440  
 D749,068 S 2/2016 Zaborski  
 D749,535 S 2/2016 Joung  
 D749,594 S 2/2016 Kim  
 D753,099 S 4/2016 Kim  
 D754,643 S \* 4/2016 Shin ..... D14/250  
 D755,168 S \* 5/2016 Kim ..... D14/250  
 D755,764 S 5/2016 Dong  
 D755,766 S \* 5/2016 Kim ..... D14/250  
 D755,770 S \* 5/2016 Kim ..... D14/250  
 D755,772 S 5/2016 Sasaki  
 D756,339 S 5/2016 Tussy  
 D756,340 S 5/2016 Babichenko  
 D756,343 S 5/2016 Wall et al.  
 D756,909 S 5/2016 Gupta  
 D756,977 S 5/2016 Schriefer  
 D756,978 S 5/2016 Addonisio  
 D756,980 S 5/2016 Beeman  
 D757,703 S 5/2016 Kanazawa  
 D759,641 S 6/2016 Lai et al.  
 D759,642 S 6/2016 Chao  
 D762,633 S 8/2016 Fife  
 D765,634 S 9/2016 McCray et al.  
 D765,635 S 9/2016 Chang  
 D765,638 S 9/2016 Gaylord  
 D765,640 S 9/2016 Bulkley  
 D768,615 S 10/2016 Wang  
 9,467,189 B2 10/2016 Day et al.  
 D771,028 S 11/2016 Kim  
 D771,068 S 11/2016 Lv et al.  
 D771,608 S 11/2016 Kim  
 D772,209 S 11/2016 Kim  
 D772,858 S 11/2016 Hu  
 D772,881 S 11/2016 Chang et al.  
 9,503,147 B2 11/2016 Witter et al.  
 D775,620 S 1/2017 Kim  
 D776,104 S 1/2017 Tien  
 D776,648 S 1/2017 Kim

D776,649 S 1/2017 Kim  
 D777,155 S 1/2017 Kim  
 D777,156 S 1/2017 Kim  
 D777,160 S 1/2017 Kim  
 9,545,140 B1 1/2017 Johnson et al.  
 D778,897 S 2/2017 Kim  
 D778,898 S 2/2017 Kim  
 D780,166 S 2/2017 Lin  
 D780,167 S 2/2017 Tien  
 D786,233 S 5/2017 Kim  
 D786,851 S 5/2017 Kim  
 D786,852 S 5/2017 Kim  
 D787,491 S 5/2017 Kim  
 D787,492 S 5/2017 Kim  
 D787,942 S 5/2017 Bos  
 D788,090 S 5/2017 Kim  
 D788,757 S 6/2017 Kim  
 D789,344 S 6/2017 Kim  
 D789,925 S \* 6/2017 Browning ..... D14/341  
 D791,755 S 7/2017 Kim  
 D795,826 S \* 8/2017 Yoon ..... D14/138 AB  
 D796,497 S 9/2017 Kim  
 D797,729 S \* 9/2017 Park ..... D14/248  
 D798,256 S \* 9/2017 Choo ..... D14/138 AA  
 D798,257 S \* 9/2017 Choo ..... D14/138 AB  
 D798,284 S 9/2017 Kim  
 D800,112 S \* 10/2017 Park ..... D14/345  
 D800,713 S 10/2017 Kim  
 D803,206 S 11/2017 Kim  
 D806,378 S \* 1/2018 Lerenthal ..... D3/201  
 D808,955 S 1/2018 Park et al.  
 D810,065 S 2/2018 Tien et al.  
 D810,066 S 2/2018 Tien et al.  
 D810,067 S \* 2/2018 Lee ..... D14/250  
 D810,726 S 2/2018 Chou et al.  
 D813,854 S 3/2018 Lee et al.  
 D819,622 S \* 6/2018 Wright ..... D14/250  
 D823,293 S 7/2018 Kim et al.  
 D823,296 S 7/2018 Kim et al.  
 D823,297 S 7/2018 Kim et al.  
 D823,298 S 7/2018 Kim et al.  
 D832,268 S 10/2018 Mecchella et al.  
 D832,852 S \* 11/2018 Jinkinson ..... D14/440  
 D835,089 S 12/2018 Nelson et al.  
 2009/0017883 A1 1/2009 Lin  
 2011/0050606 A1 3/2011 Zhang  
 2013/0077211 A1 3/2013 Wang  
 2013/0126531 A1 5/2013 Hyneczek  
 2014/0262855 A1 9/2014 Gandhi  
 2014/0360892 A1 12/2014 Lin  
 2015/0156297 A1 6/2015 Crawford  
 2015/0335116 A1 11/2015 Kim  
 2016/0028430 A1 1/2016 Crawford

OTHER PUBLICATIONS

“Spigen Slim Armor iPhone 5S /SE/5 Case with Advanced Drop Protection and Dual Layer Design for iPhone 5S/iPhone SE/iPhone 5—Metal Slate”, <https://www.amazon.com/dp/B00DD62R40>, Earliest review date of Dec. 14, 2012, Downloaded on Sep. 18, 2018.  
 “Spigen Slim Armor View Galaxy S4 Case with Automatic Sleep / Wake Feature for Galaxy S4 2013—Soul Black”, <https://www.amazon.com/dp/B00DCCVS5Y>, Earliest review date of Mar. 18, 2013, Downloaded on Feb. 19, 2019.  
 “Spigen Slim Armor Nexus 5 Case with Air Cushion Technology and Hybrid Drop Protection for Nexus 5 2013—Infinity Nite”, <https://www.amazon.com/dp/B00EV8Y7XI>, Earliest review date of Nov. 4, 2013, Downloaded on Jan. 16, 2019.  
 “Spigen Slim Armor View Galaxy S5 Case with Automatic Sleep / Wake Feature for Samsung Galaxy S5 2014—View Smooth White”, <https://www.amazon.com/dp/B00KGG02EI>, Earliest review date of Jan. 18, 2014, Downloaded on Jan. 16, 2019.  
 “Spigen Slim Armor Galaxy S5 Case with Air Cushion Technology and Hybrid Drop Protection for Samsung Galaxy S5 2014—Metal Slate”, <https://www.amazon.com/dp/B00I3UWD7C>, Earliest review date of Apr. 11, 2014, Downloaded on Sep. 18, 2018.

(56)

## References Cited

## OTHER PUBLICATIONS

“Spigen Slim Armor LG G3 Case with Air Cushion Technology and Hybrid Drop Protection for LG G3 2014—Metal Slate”, <https://www.amazon.com/dp/B00JQI2G50>, Earliest review date of Jul. 9, 2014, Downloaded on Jan. 16, 2019.

“Spigen Slim Armor iPhone 6 Case with Air Cushion Technology and Hybrid Drop Protection for iPhone 6 2014 Gunmetal”, <https://www.amazon.com/dp/B00JH88GB6>, Earliest review date of Aug. 13, 2014, Downloaded on Sep. 18, 2018.

“Spigen Slim Armor iPhone 6 Plus Case with Air Cushion Technology and Hybrid Drop Protection for iPhone 6S Plus / iPhone 6 Plus—Shimmery White”, <https://www.amazon.com/dp/B00JH83C6U>, Earliest review date of Sep. 12, 2014, Downloaded on Sep. 18, 2018.

“Spigen Slim Armor Galaxy Note 4 Case with Air Cushion Technology and Hybrid Drop Protection for Samsung Galaxy Note 4 2014—Shimmery White”, <https://www.amazon.com/dp/B00MAWQPJQ>, Earliest review date of Oct. 7, 2014, Downloaded on Jul. 30, 2018.

“Spigen Slim Armor Galaxy S6 Case with Air Cushion Technology and Hybrid Drop Protection with Kickstand for Samsung Galaxy S6 (2015)—Shimmery White”, <https://www.amazon.com/dp/B00QU4NQMY>, Earliest review date of Mar. 21, 2015, Downloaded on Sep. 18, 2018.

“Spigen Slim Armor HTC One M9 Case with Kickstand and Air Cushion Technology Hybrid Drop Protection for HTC One M9 2015—Metal Slate”, <https://www.amazon.com/dp/B00SNOTASI>, Earliest review date of Mar. 31, 2015, Downloaded on Jan. 16, 2019.

Spigen Slim Armor Galaxy S6 Edge Case with Kickstand and Air Cushion Technology and Hybrid Drop Protection for Galaxy S6 Edge 2015—Gunmetal, <https://www.amazon.com/dp/B00SV638ZE>, Earliest review date of Apr. 3, 2015, Downloaded on Sep. 18, 2018.

“Spigen Slim Armor Galaxy Note 5 Case with Air Cushion Technology and Hybrid Drop Protection for Galaxy Note 5 2015—Metal Slate”, <https://www.amazon.com/dp/B010MWHIKA>, Earliest review date of Aug. 21, 2015, Downloaded on Jul. 18, 2018.

“Spigen Slim Armor iPhone 6S Case with Kickstand and Air Cushion Technology Hybrid Drop Protection for iPhone 6S 2015—Rose Gold”, <https://www.amazon.com/dp/B012PKFAQ6>, Earliest review date of Sep. 1, 2015, Downloaded on Sep. 18, 2018.

Korguenkomodo, “Slim Armor case—Galaxy S6 Edge Plus”, Published on Oct. 12, 2015, Downloaded on Mar. 19, 2019.

“Spigen Slim Armor LG V10 Case with Air Cushion Technology and Hybrid Drop Protection for LG V10—Gunmetal”, <https://www.amazon.com/dp/B016X1FODW>, Earliest review date of Nov. 16, 2015, Downloaded on Sep. 18, 2018.

“Spigen Slim Armor Galaxy S7 Edge Case with Kickstand and Air Cushion Technology and Hybrid Drop Protection for Samsung Galaxy S7 Edge 2016—Champagne Gold”, <https://www.amazon.com/dp/B01BEBBWY6>, Earliest review date of Feb. 26, 2016, Downloaded on Sep. 18, 2018.

“Spigen Slim Armor Galaxy S7 Case with Air Cushion Technology and Hybrid Drop Protection for Samsung Galaxy S7 2016—Violet”, <https://www.amazon.com/dp/B01AUR1D8K>, Earliest review date of Mar. 2, 2016, Downloaded on Sep. 18, 2018.

“Spigen Slim Armor iPhone SE Case with Air Cushion Technology and Hybrid Drop Protection for iPhone SE 2016 Rose Gold”, <https://www.amazon.com/dp/B01BEJOH5E>, Earliest review date of Apr. 6, 2016, Downloaded on Jan. 16, 2019.

“Spigen Slim Armor LG G5 Case with Air Cushion Technology and Hybrid Drop Protection for LG G5 2016—Shimmery White”, <https://www.amazon.com/dp/B01B1GQIHA>, Earliest review date of Apr. 7, 2016, Downloaded on Sep. 18, 2018.

“Spigen Slim Armor HTC 10 Case with Kickstand and Air Cushion Technology Hybrid Drop Protection for HTC 10 2016—Champagne Gold”, <https://www.amazon.com/dp/B01DAN2WTA>, Earliest review date of May 6, 2016, Downloaded on Jan. 16, 2019.

“Spigen Slim Armor iPhone 7 / iPhone 8 Case with Kickstand and Air Cushion Technology Hybrid Drop Protection for Apple iPhone

7 (2016) / iPhone 8 (2017)—Black”, <https://www.amazon.com/dp/B01HMY5WKY>, Earliest review date of Sep. 12, 2016, Downloaded on Sep. 18, 2018.

“Spigen Slim Armor iPhone 7 Plus Case with Kickstand and Air Cushion Technology Hybrid Drop Protection for Apple iPhone 7 Plus (2016)—Black”, <https://www.amazon.com/dp/B01HMY5Y3E>, Earliest review date of Sep. 22, 2016, Downloaded on Jan. 16, 2019.

“Spigen Tough Armor iPhone SE/5S/5 Case with Extreme Heavy Duty Protection and Air Cushion Technology for iPhone SE/iPhone 5S/iPhone 5—Metal Slate”, <https://www.amazon.com/Spigen-Extreme-Protection-Cushion-Technology/dp/B00DMKGPP4>, Earliest review date of Aug. 1, 2013, Downloaded on Aug. 9, 2018.

“Spigen Tough Armor Designed for Apple iPad Mini 3 Case, iPad Mini 2 Case, iPad Mini Case—Metal Slate”, <https://www.amazon.com/Spigen-Tough-Armor-Designed-Apple/dp/B00FRVDVXK>, Earliest review date of Dec. 27, 2013, Downloaded on Jan. 15, 2019.

“Spigen Tough Armor Galaxy S5 Case with Extreme Heavy Duty Protection and Air Cushion Technology for Samsung Galaxy S5 2014—Gunmetal”, <https://www.amazon.com/Spigen-Extreme-Protection-Cushion-Technology/dp/B00I3UWDV8>, Earliest review date of Mar. 9, 2014, Downloaded on Aug. 9, 2018.

“Spigen Tough Armor iPhone 6 Plus Case with Kickstand and Extreme Heavy Duty Protection and Air Cushion Technology for iPhone 6S Plus / iPhone 6 Plus—Gunmetal”, <https://www.amazon.com/dp/B00LL987W2>, Earliest review date of Jul. 8, 2014, Downloaded on Oct. 4, 2017.

“Spigen Tough Armor iPhone 6 Case with Extreme Heavy Duty Protection and Air Cushion Technology for iPhone 6S/ iPhone 6—Smooth Black”, <https://www.amazon.com/Spigen-Extreme-Protection-Cushion-Technology/dp/B00NSSX23I>, Earliest review date of Aug. 14, 2014, Downloaded on Aug. 9, 2018.

“Spigen Tough Armor iPhone 6 Case with Extreme Heavy Duty Protection and Air Cushion Technology for iPhone 6S / iPhone 6—Gunmetal”, <https://www.amazon.com/Spigen-Extreme-Protection-Cushion-Technology/dp/B00LL60JU8>, Earliest review date of Sep. 10, 2014, Downloaded on Jan. 15, 2019.

“Spigen Tough Armor S iPhone 6 Case with Extreme Heavy Duty Protection and Card Kickstand Feature for iPhone 6S / iPhone 6—S Mint”, <https://www.amazon.com/Spigen-Extreme-Protection-Kickstand-Feature/dp/B00LL65B06>, Earliest review date of Sep. 18, 2014, Downloaded on Jan. 15, 2019.

“Spigen Tough Armor Galaxy Note 4 Case with Extreme Heavy Duty Protection and Air Cushion Technology for Samsung Galaxy Note 4 2014—Gunmetal”, <https://www.amazon.com/dp/B00MAWQU14>, Earliest review date of Oct. 9, 2014, Downloaded on Aug. 31, 2018.

“Spigen Tough Armor FX iPhone 6 Case with Extreme Protection and Front Built-In Screen Protector Cover for iPhone 6S / iPhone 6—Gunmetal”, <https://www.amazon.com/Spigen-iPhone-Extreme-Protection-Protector/dp/B00PR9XE5C>, Earliest review date of Jan. 8, 2015, Downloaded on Jan. 15, 2019.

“Spigen Tough Armor Galaxy S6 Edge Case with Kickstand and Extreme Heavy Duty Protection and Air Cushion Technology for Galaxy S6 Edge 2015—Gunmetal”, <https://www.amazon.com/dp/B00SV63L38>, Earliest review date of Mar. 12, 2015, Downloaded on Aug. 9, 2018.

“Spigen Tough Armor Galaxy S6 Case with Kickstand and Air Cushion Technology for Galaxy S6 2015—Gunmetal”, <https://www.amazon.com/dp/B00QU4PUKK>, Earliest review date of Mar. 23, 2015, Downloaded on Aug. 9, 2018.

Spigen Tough Armor iPhone 6S Case with Extreme Heavy Duty Protection and Air Cushion Technology for iPhone 6S/iPhone 6—Rose Gold, <https://www.amazon.com/dp/B013TKNNGK>, Earliest review date of Aug. 30, 2015, Downloaded on Aug. 8, 2018.

“Spigen Tough Armor iPhone 6S Plus Case with Kickstand and Heavy Duty Air Cushion Technology Protection for iPhone 6S Plus/iPhone 6 Plus Only—Gunmetal”, <https://www.amazon.com/Spigen-Kickstand-Cushion-Technology-Protection/dp/B010MVQJPQ>, Earliest review date of Sep. 9, 2015, Downloaded on Aug. 9, 2018.

“Spigen Tough Armor Galaxy S7 Edge Case with Kickstand and Extreme Heavy Duty Protection and Air Cushion Technology for

(56)

**References Cited**

## OTHER PUBLICATIONS

Samsung Galaxy S7 Edge 2016—Gunmetal”, <https://www.amazon.com/dp/B01A7IDNWQ>, Earliest review date of Feb. 24, 2016, Downloaded on Aug. 9, 2018.

“Spigen Tough Armor Galaxy S7 Case with Extreme Heavy Duty Protection and Air Cushion Technology for Samsung Galaxy S7 2016—Gunmetal”, <https://www.amazon.com/dp/B01A7ID3PS>, Earliest review date of Feb. 25, 2016, Downloaded on Aug. 9, 2018.

“Spigen Tough Armor LG G5 Case with Reinforced Kickstand and Heavy Duty Protection and Air Cushion Technology for LG G5 (2016)—Gunmetal”, <https://www.amazon.com/dp/B01B1GQL6I>, Earliest review date of Mar. 11, 2016, Downloaded on Aug. 9, 2018.

“Spigen Tough Armor iPhone SE Case with Extreme Heavy Duty Protection and Air Cushion Technology for iPhone SE 2016—Black”, <https://www.amazon.com/Spigen-Extreme-Protection-Cushion-Technology/dp/B01BEJB9XM>, Earliest review date of Apr. 7, 2016, Downloaded on Aug. 9, 2018.

“Spigen Tough Armor Heavy Duty Extreme Protection Rugged Slim Dual Layer Protective Cover Case for Apple iPhone 7—Gunmetal”, <https://www.amazon.co.uk/dp/B01GIVWY30>, Date first available at Amazon.co.uk of Aug. 2, 2016, Downloaded on Sep. 17, 2018.

“Spigen Tough Armor iPhone 7 Plus / iPhone 8 Plus Case with Extreme Heavy Duty Protection and Air Cushion Technology with Kickstand for Apple iPhone 7 Plus 2016/ iPhone 8 Plus 2017—Rose Gold”, <https://www.amazon.com/Jp/B01GIWGE8A>, Earliest review date of Sep. 6, 2016, Downloaded on Aug. 9, 2018.

“Spigen Tough Armor iPhone 7 Case with Extreme Heavy Duty Protection and Air Cushion Technology for iPhone 7 2016—Black”, <https://www.amazon.com/dp/B01GIVX30I>, Earliest review date of Sep. 9, 2016, Downloaded on Aug. 9, 2018.

“Spigen Tough Armor iPhone 7 Case with Jet Black Optimized Color and Extreme Heavy Duty Protection and Air cushion Tech-

nology for iPhone 7 2016—Jet Black”, <https://www.amazon.com/Spigen-Optimized-Extreme-Protection-Technology/dp/B01LRSFLFM>, Earliest review date of Sep. 25, 2016, Downloaded on Aug. 9, 2018.

“Spigen Tough Armor Google Pixel Case with Kickstand and Heavy Duty Air Cushion Technology Protection for Google Pixel 2016—Black”, <https://www.amazon.com/Spigen-Kickstand-Cushion-Technology-Protection/dp/B01M12Z4PY>, Earliest review date of Oct. 20, 2016, Downloaded on Aug. 9, 2018.

“Spigen Tough Armor Google Pixel XL Case with Kickstand and Heavy Duty Air Cushion Technology Protection for Google Pixel XL 2016—Gunmetal”, <https://www.amazon.com/Spigen-Kickstand-Cushion-Technology-Protection/dp/B01LZGCH6E>, Earliest review date of Oct. 21, 2016, Downloaded on Aug. 9, 2018.

“Spigen Tough Armor LG V20 Case with Kickstand and Extreme Heavy Duty Protection and Air Cushion Technology for LG V20—Gunmetal”, <https://www.amazon.com/Spigen-Kickstand-Extreme-Protection-Technology/dp/B01M9FI54B>, Earliest review date of Dec. 2, 2016, Downloaded on Aug. 9, 2018.

“Spigen Tough Armor Designed for Apple Watch Case for 42mm Series 3 / Series 2/1 / Original (2015) / Nike+ Sport Edition and Built in Screen Protector—Gunmetal”, <https://www.amazon.com/dp/B01N74P26H>, Earliest review date of Jan. 4, 2017, Downloaded on Jan. 15, 2019.

“Spigen Tough Armor LG G6 Case with Extreme Heavy Duty Protection and Air Cushion Technology for LG G6 (2017) Black”, <https://www.amazon.com/dp/B01MR8C4RY>, Earliest review date of Mar. 26, 2017, Downloaded on Aug. 9, 2018.

“Spigen Tough Armor Galaxy S8 Plus Case with Reinforced Kickstand and Heavy Duty Protection and Air Cushion Technology for Samsung Galaxy S8 Plus (2017)—Black”, <https://www.amazon.com/dp/B06XP4FP8N>, Earliest review late of Apr. 8, 2017, Downloaded on Aug. 9, 2018.

\* cited by examiner

FIG. 1

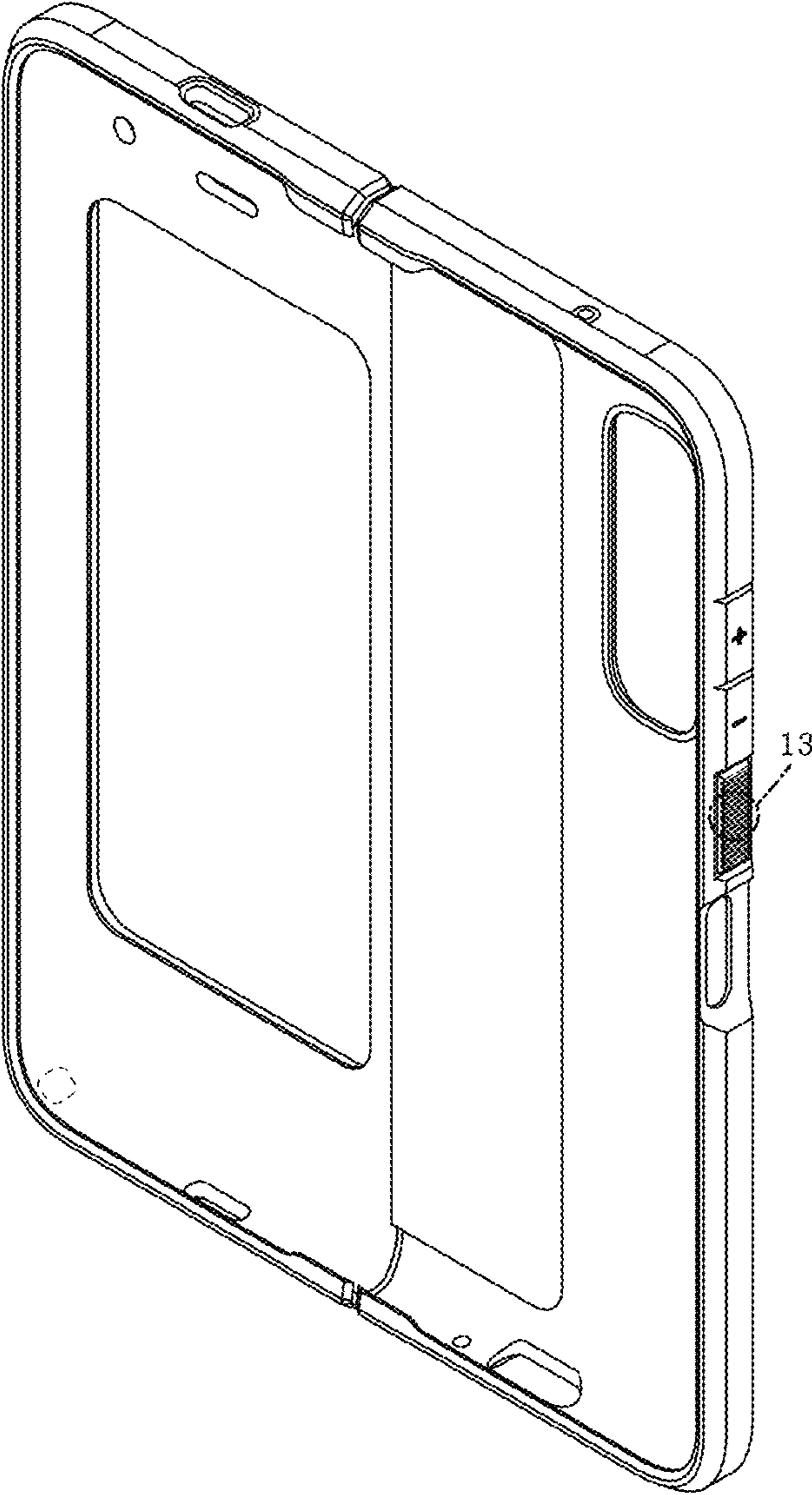

FIG. 2

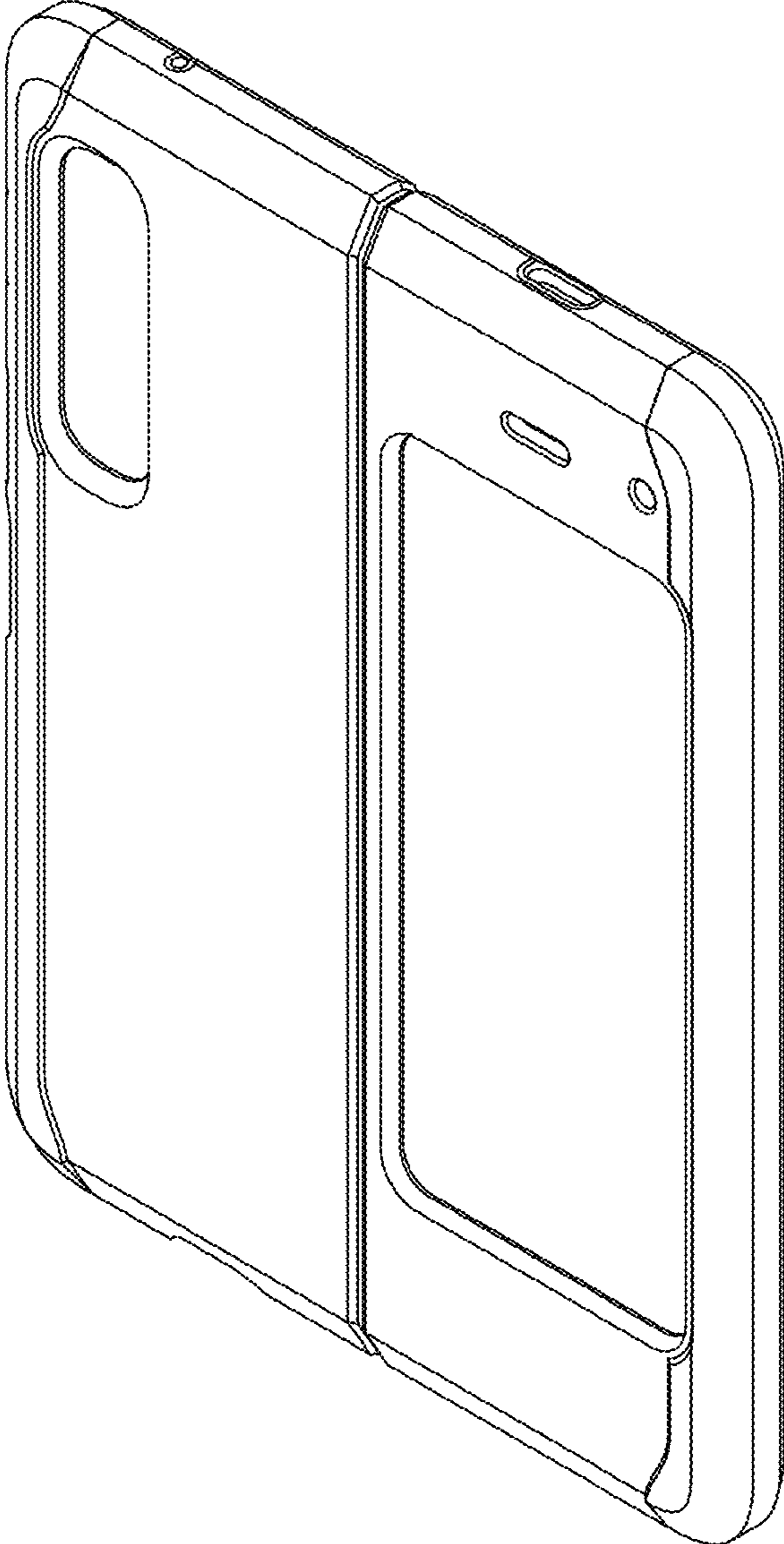

FIG. 3

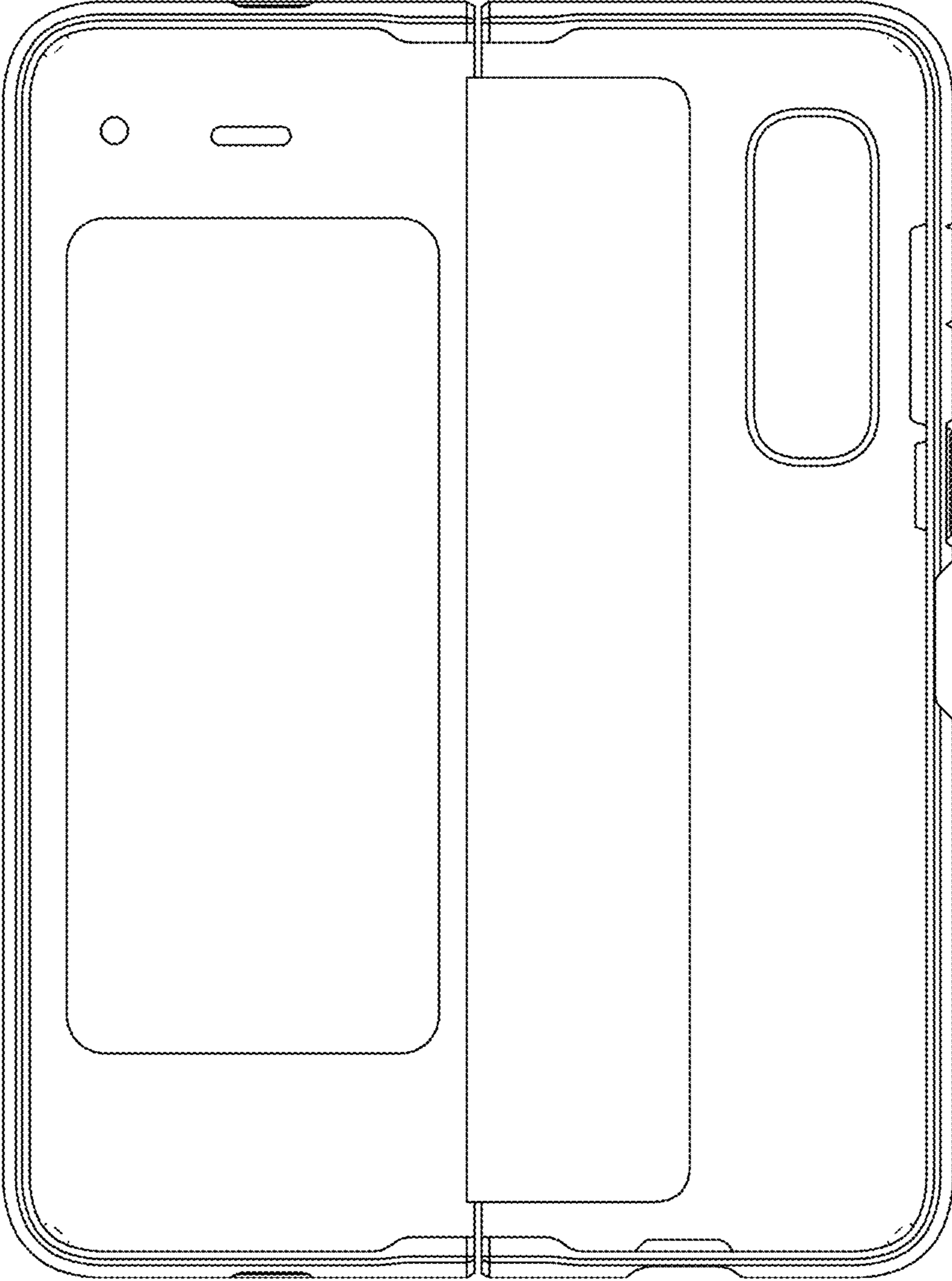

FIG. 4

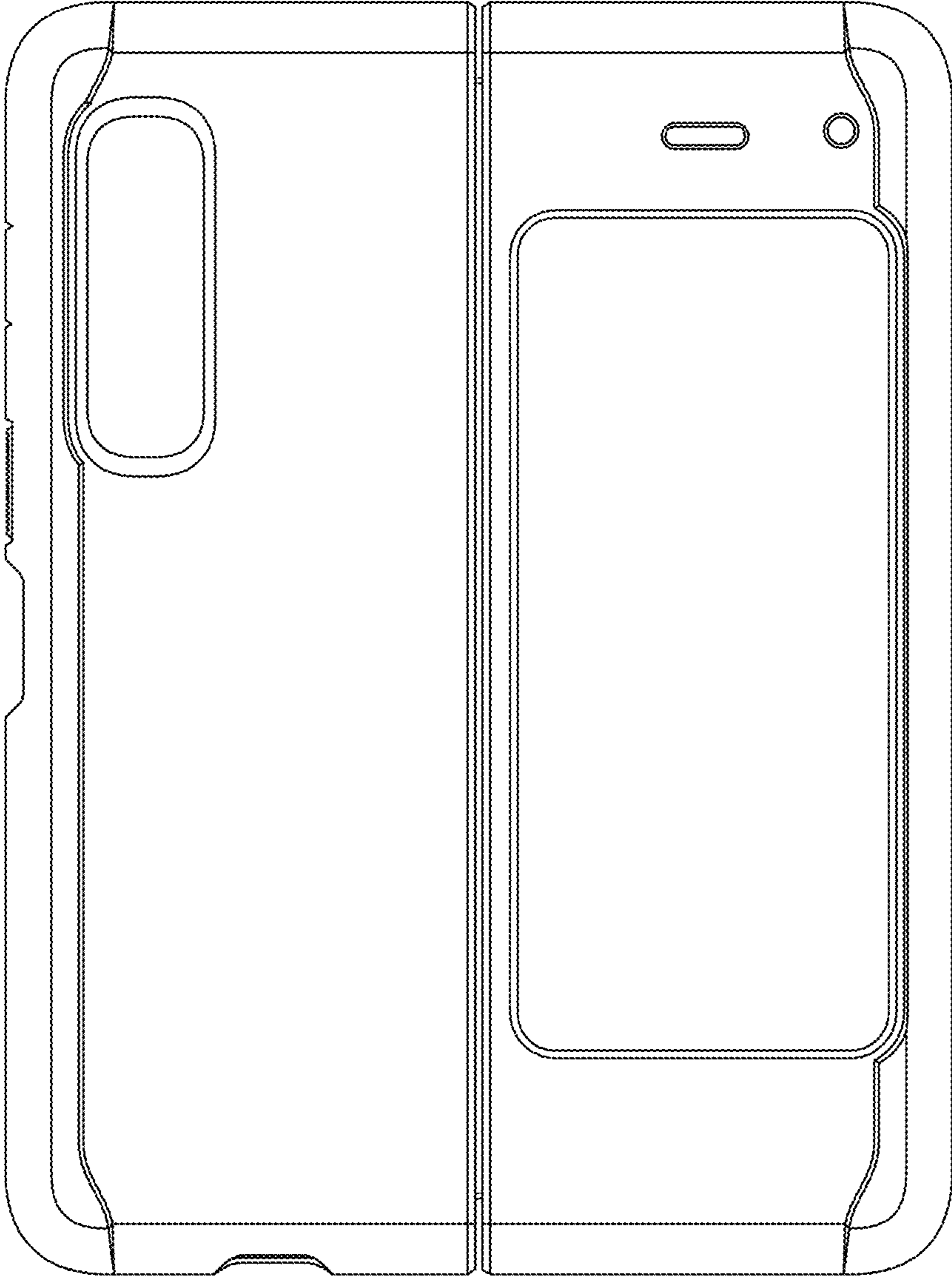



FIG. 5

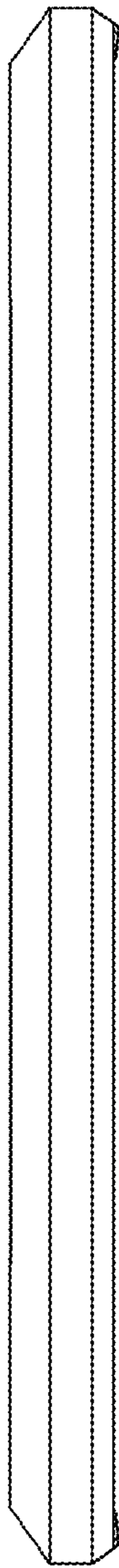

FIG. 6

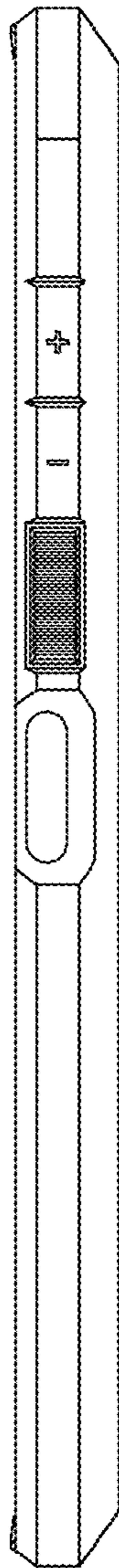

FIG. 7

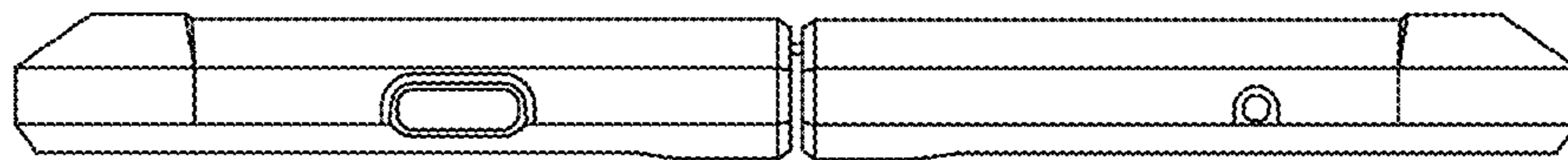

FIG. 8

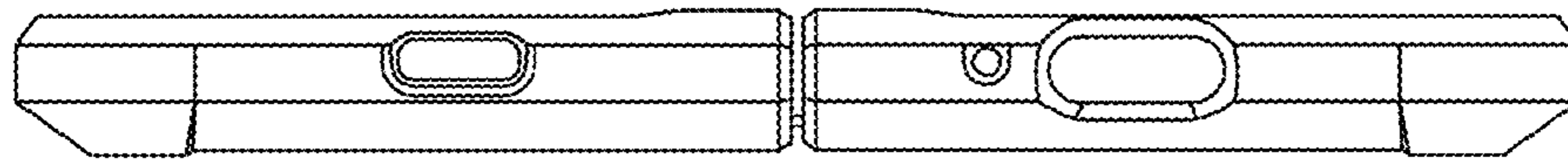

FIG. 9

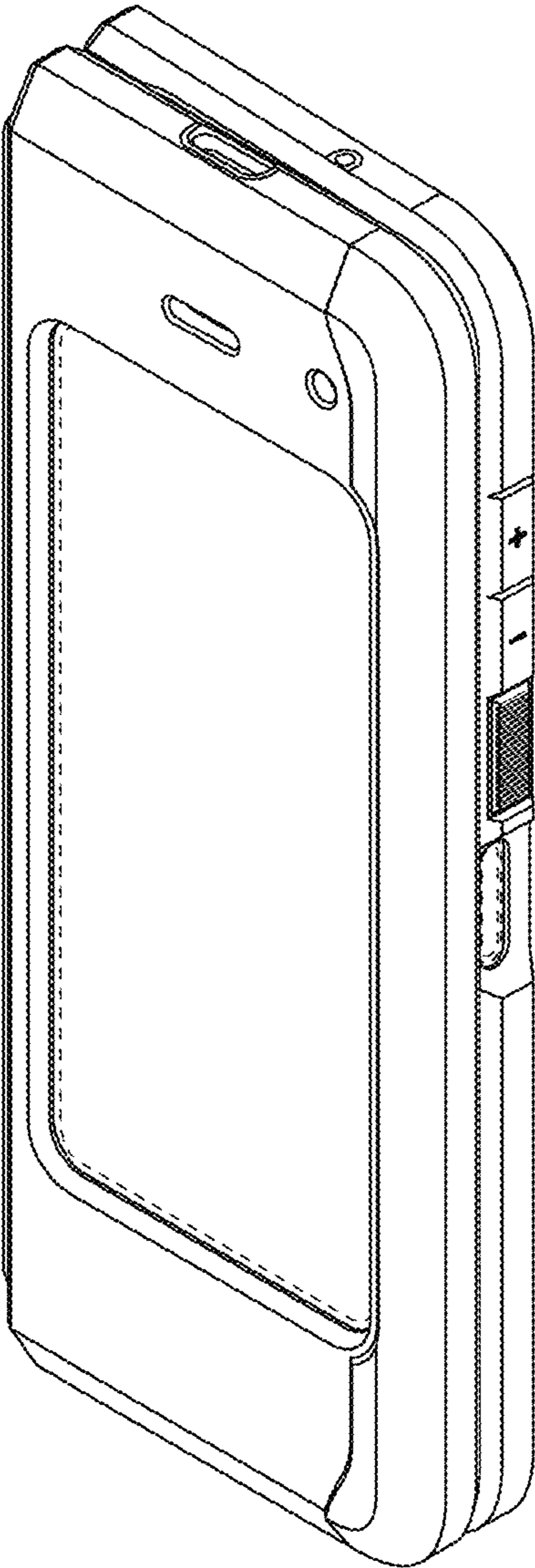

FIG. 10

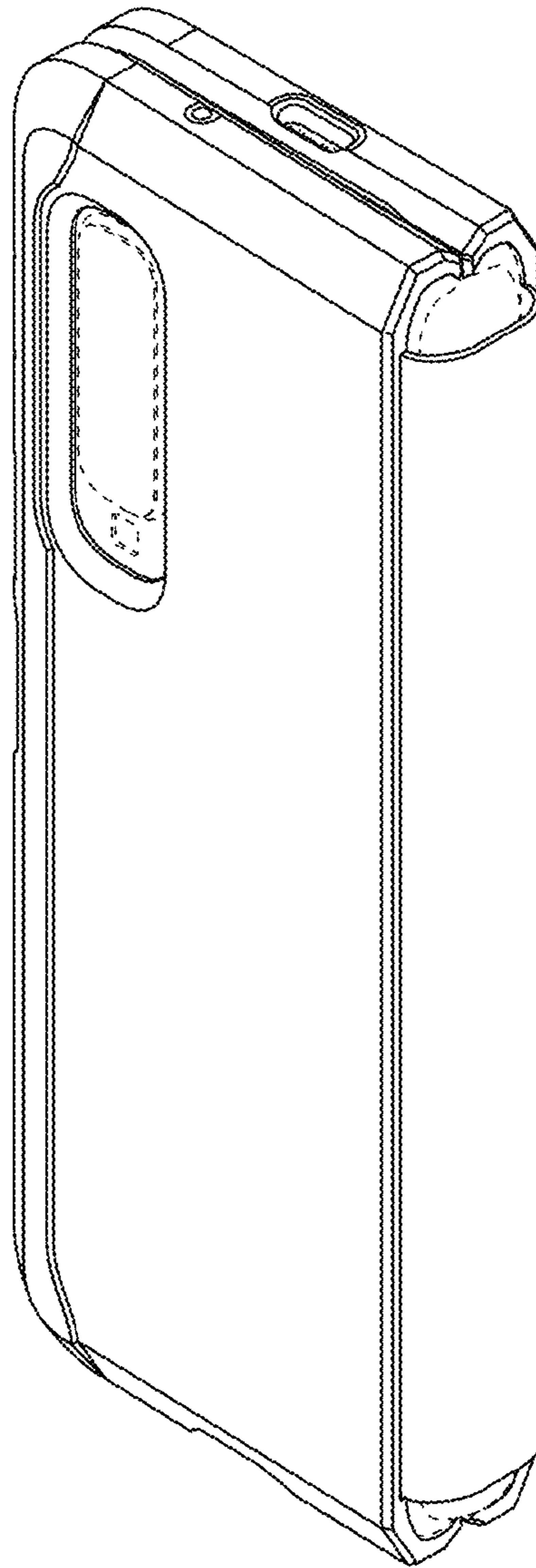

FIG. 11

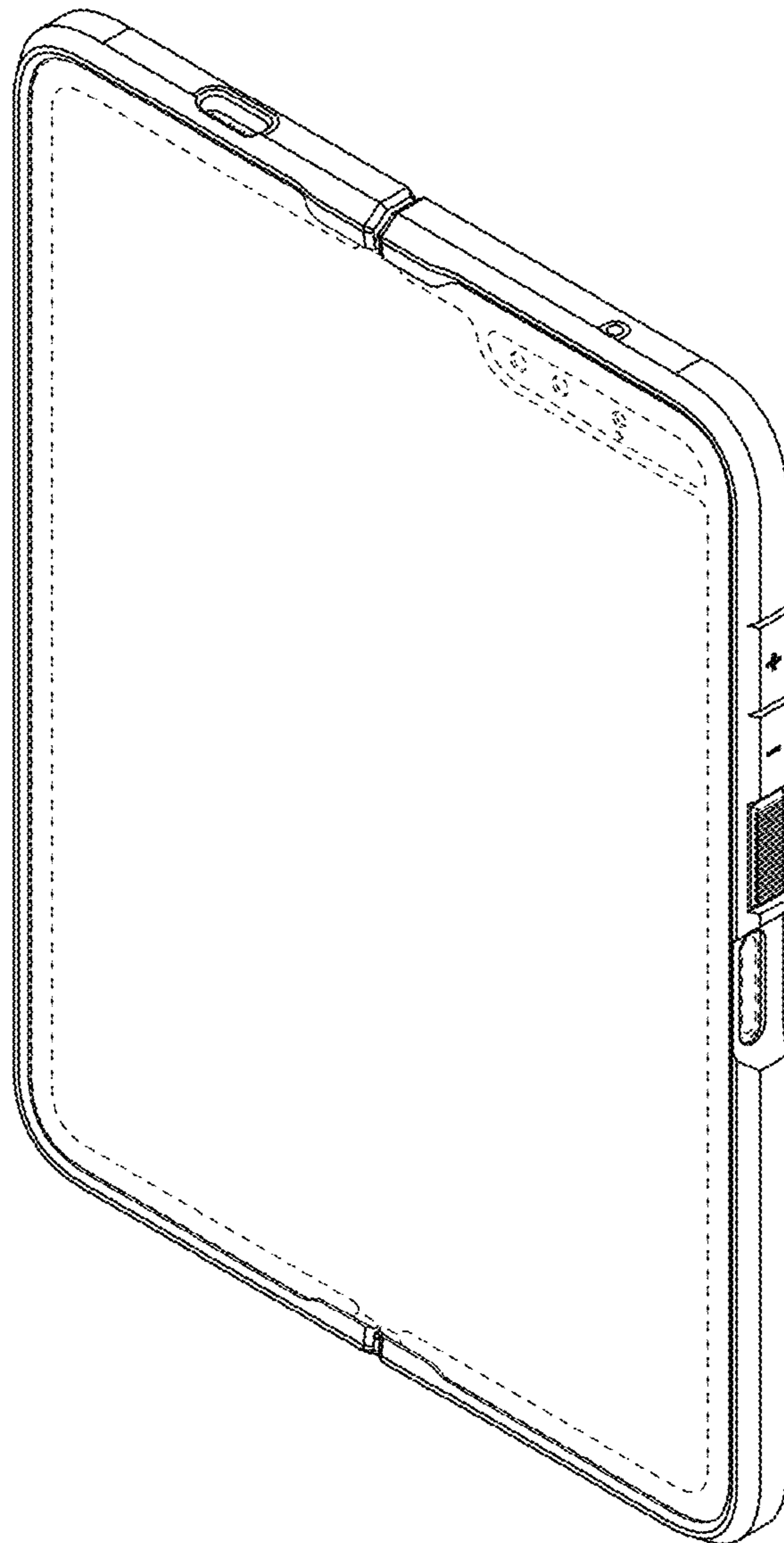

FIG. 12

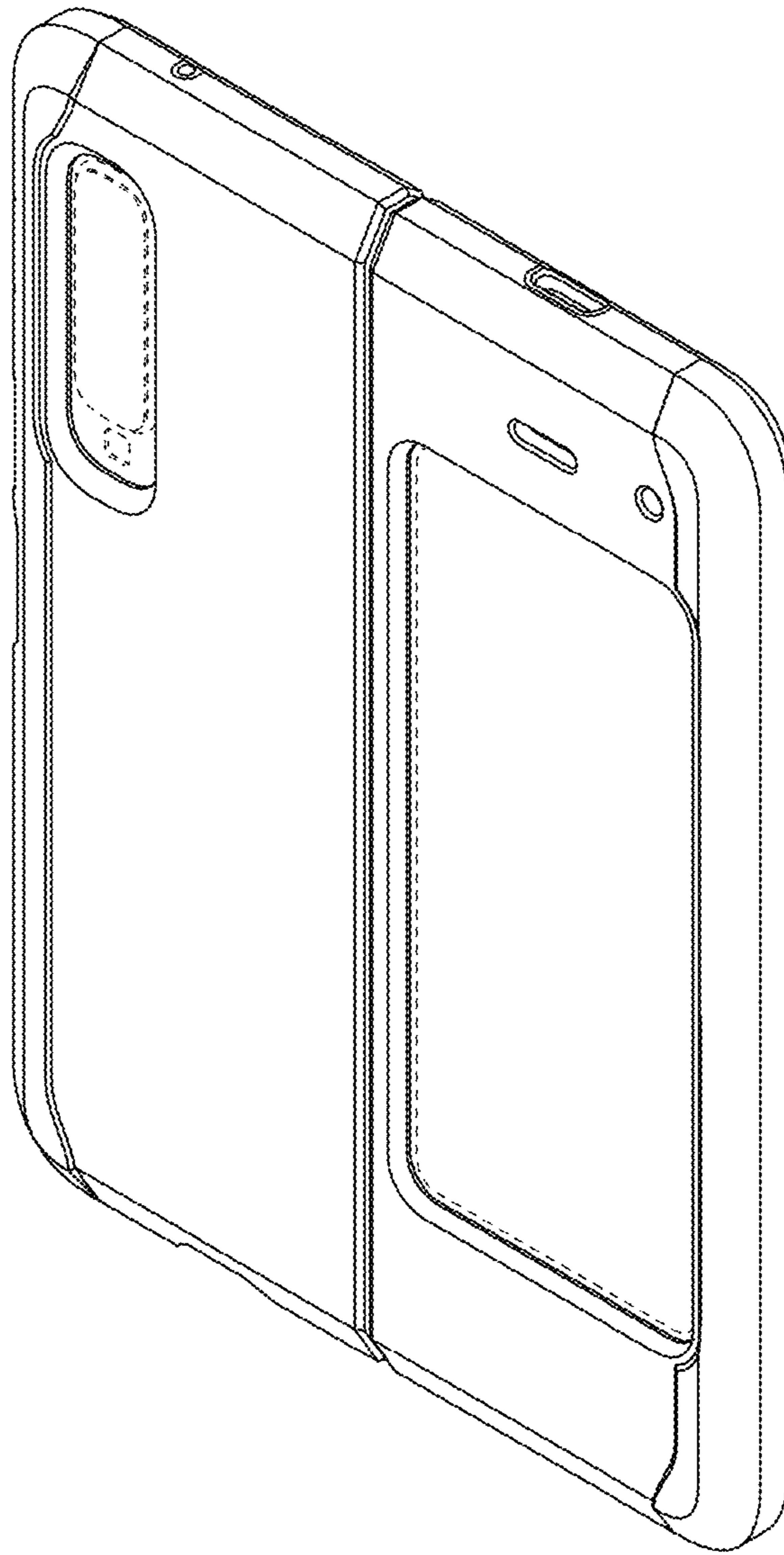



FIG. 13

