



US00D877069S

(12) **United States Design Patent**
Kern et al.

(10) **Patent No.:** **US D877,069 S**
(45) **Date of Patent:** **** Mar. 3, 2020**

(54) **CHARGER**

(71) Applicant: **Fitbit, Inc.**, San Francisco, CA (US)
(72) Inventors: **Anthony Gerald Kern**, Pleasant Hill, CA (US); **Benjamin Patrick Robert Jean Riot**, San Francisco, CA (US); **Ching-Lung Hsu**, Taipei (TW)
(73) Assignee: **FITbit, inc.**, San Francisco, CA (US)

(**) Term: **15 Years**

(21) Appl. No.: **29/656,560**

(22) Filed: **Jul. 13, 2018**

(51) **LOC (12) Cl.** **13-02**

(52) **U.S. Cl.**
USPC **D13/108**

(58) **Field of Classification Search**
USPC D13/107–110, 118–119, 184; D14/251, D14/253, 432, 434, 447
CPC Y02E 60/12; Y02T 90/14; Y02T 90/122; Y02T 90/128; Y02T 90/163; Y02T 10/7005; Y02T 10/7088; H02J 7/025; H02J 7/0042; H02J 7/0044; H02J 7/0045; H02J 7/0003; H01F 38/14; H01R 13/6675; H01M 2/1022; H01M 2/1055; H01M 10/44; H01M 10/46; H01M 10/425; B60L 11/182

See application file for complete search history.

(56) **References Cited**

U.S. PATENT DOCUMENTS

D297,827 S 9/1988 Lay
D350,545 S * 9/1994 Olkkola D14/142
D417,431 S 12/1999 Okura et al.
D422,556 S 4/2000 Okura et al.
D428,597 S 7/2000 Murata et al.
D442,939 S 5/2001 Goldenburg
D455,713 S 4/2002 Forakis

D471,547 S * 3/2003 Ruohonen D14/253
D477,823 S 7/2003 Lavello, Sr.
D516,023 S 2/2006 Quinn
D520,448 S 5/2006 Lodato et al.
D529,905 S * 10/2006 Richter D14/253
D530,713 S * 10/2006 Richter D14/253
D535,614 S 1/2007 Majanen et al.
D558,193 S 12/2007 Ju
7,311,526 B2 12/2007 Rohrbach et al.
D580,855 S 11/2008 Haspil et al.
D621,347 S 8/2010 Aulwes et al.
D630,582 S 1/2011 Dai et al.
D635,874 S 4/2011 Tseng et al.

(Continued)

OTHER PUBLICATIONS

Fitbit Ace charging cable—<https://www.fitbit.com/shop/accessories/ace-charging-cable>. On sale 2018. Website accessed Mar. 27, 2019.

(Continued)

Primary Examiner — Rosemary K Tarcza
(74) *Attorney, Agent, or Firm* — Polson Intellectual Property Law, PC; Margaret Polson

(57) **CLAIM**

The ornamental design for a charger, as shown and described.

DESCRIPTION

FIG. 1 is a top, left side isometric view of our new design for a charger.

FIG. 2 is a front side elevation view of FIG. 1.

FIG. 3 is a back side elevation view of FIG. 1.

FIG. 4 is a right side elevation view of FIG. 1.

FIG. 5 is a left side elevation view of FIG. 1.

FIG. 6 is a top side plan view of FIG. 1; and,

FIG. 7 is a bottom side plan view of FIG. 1.

The features shown in broken lines in the drawings depict portions of the charger that form no part of the claimed design.

1 Claim, 6 Drawing Sheets

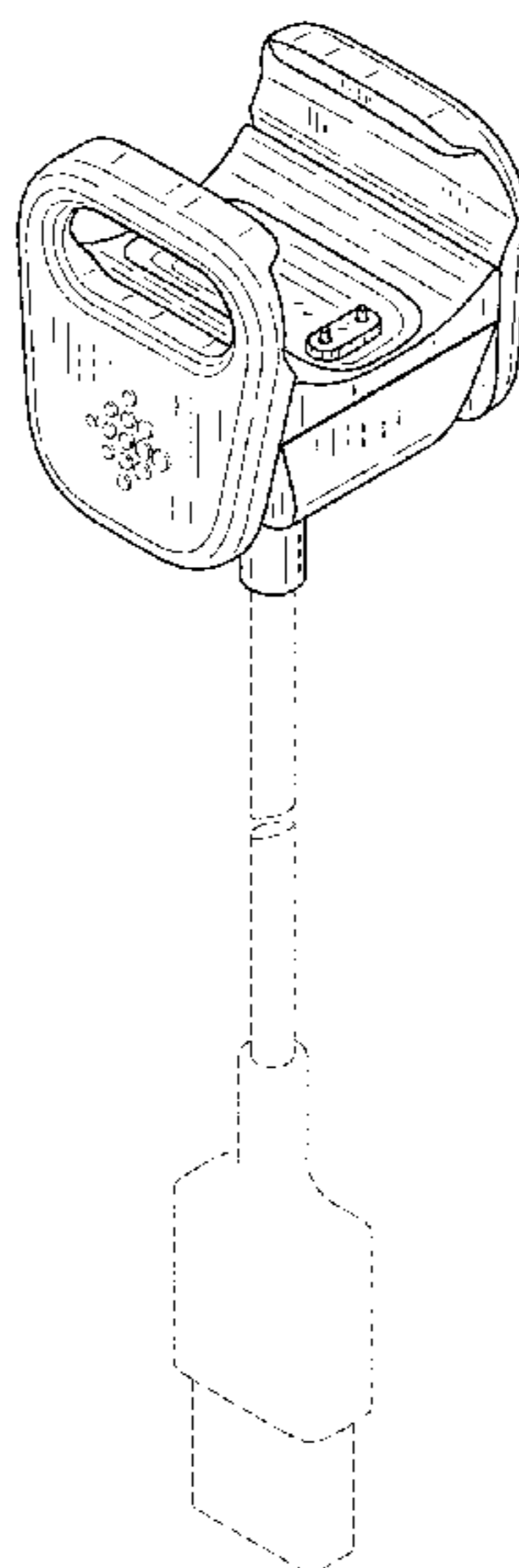

(56)

References Cited

U.S. PATENT DOCUMENTS

D637,155 S	5/2011	Jeon et al.	
D665,501 S	8/2012	Shibata et al.	
D673,952 S	1/2013	Toda et al.	
D680,491 S	4/2013	Paschke et al.	
D690,137 S	9/2013	Kikkert et al.	
D690,707 S	* 10/2013	Minn	B60R 11/0241 D14/447
D715,790 S	* 10/2014	Conomos	D14/253
D720,759 S	* 1/2015	Deng	D14/447
D723,459 S	3/2015	Dang et al.	
D725,285 S	3/2015	Wohlstadter et al.	
D727,877 S	4/2015	Seoc	
D733,142 S	6/2015	Solomon et al.	
D740,262 S	10/2015	Hasegawa et al.	
D761,262 S	7/2016	Solomon et al.	
D766,236 S	9/2016	Solomon et al.	
D766,747 S	9/2016	Repp	
D766,908 S	* 9/2016	Richter	D14/447
D770,416 S	11/2016	Tkachuk et al.	
D775,627 S	1/2017	Yang et al.	
D776,656 S	1/2017	Lagerstedt et al.	
D780,743 S	* 3/2017	Chun	D14/253
D784,923 S	* 4/2017	Song	D13/108
D786,200 S	5/2017	Lagerstedt et al.	
D791,696 S	6/2017	Tinius	
D799,203 S	* 10/2017	Karl, IV	D3/218
D800,060 S	10/2017	Solland et al.	
D816,046 S	4/2018	Kiong et al.	
D825,546 S	* 8/2018	Fan	D14/253
D829,652 S	10/2018	King et al.	
D832,306 S	10/2018	Liao	
D833,971 S	11/2018	Yun	
D845,960 S	* 4/2019	Yao	D14/447
D847,801 S	* 5/2019	Wengreen	D14/238.1
D854,006 S	* 7/2019	Wang	D14/253
2016/0380446 A1	12/2016	Loewen	

OTHER PUBLICATIONS

Fitbit Ace 2 charging cable—<https://www.fitbit.com/shop/accessories/inspire-ace2-charging-cable>. On sale Mar. 2019. Website accessed Mar. 27, 2019.

Fitbit Alta charging cable—<https://www.fitbit.com/shop/accessories/alta-charging-cable>. On sale Feb. 2016. Website accessed Mar. 27, 2019.

Fitbit Alta HR charging cable—<https://www.fitbit.com/shop/accessories/altahr-charging-cable>. On sale Mar. 2017. Website accessed Mar. 27, 2019.

Fitbit Blaze charging cable—<https://www.fitbit.com/shop/accessories/blaze-charging-cable>. on sale Jan. 2016. Website accessed Mar. 27, 2019.

Fitbit Charge charging cable—<https://www.fitbit.com/shop/accessories/charge-charging-cable>. On sale Nov. 2014. Website accessed Mar. 27, 2019.

Fitbit Charge2 charging cable—<https://www.fitbit.com/shop/accessories/charge2-charging-cable>. On sale 2016. Website accessed Mar. 27, 2019.

Fitbit Charge3 charging cable—<https://www.fitbit.com/shop/accessories/charge3-charging-cable>. On sale 2018. Website accessed Mar. 27, 2019.

Fitbit ChargeHR charging cable—<https://www.fitbit.com/shop/accessories/chargehr-charging-cable>. On sale Jan. 2015. Website accessed Mar. 27, 2019.

Fitbit Flex charging cable—<https://www.fitbit.com/shop/accessories/flex-charging-cable>. On sale May 2013. Website accessed Mar. 27, 2019.

Fitbit Flex 2 charging cable—<https://www.fitbit.com/shop/accessories/flex2-charging-cable>. On sale Oct. 2016. Website accessed Mar. 27, 2019.

Fitbit Ionic charging cable—<https://www.fitbit.com/shop/accessories/ionic-charging-cable>. On sale Sep. 2017. Website accessed Mar. 27, 2019.

Fitbit One charging cable—<https://www.fitbit.com/shop/accessories/one-charging-cable>. On sale Sep. 2012. Website accessed Mar. 27, 2019.

Fitbit Surge charging cable—<https://www.fitbit.com/shop/accessories/surge-charging-cable>. On sale Oct. 2014. Website accessed Mar. 27, 2019.

Fitbit Versa charging cable—<https://www.fitbit.com/shop/accessories/versa-charging-cable>. On sale Apr. 2018. Website accessed Mar. 27, 2019.

Design U.S. Appl. No. 29/627,003, filed Nov. 21, 2017.

Design U.S. Appl. No. 29/663,874, filed Sep. 19, 2018.

Design U.S. Appl. No. 29/683,052, filed Mar. 11, 2019.

Design U.S. Appl. No. 29/630,648, filed Dec. 21, 2017.

Design U.S. Appl. No. 29/630,650, filed Dec. 21, 2017.

* cited by examiner

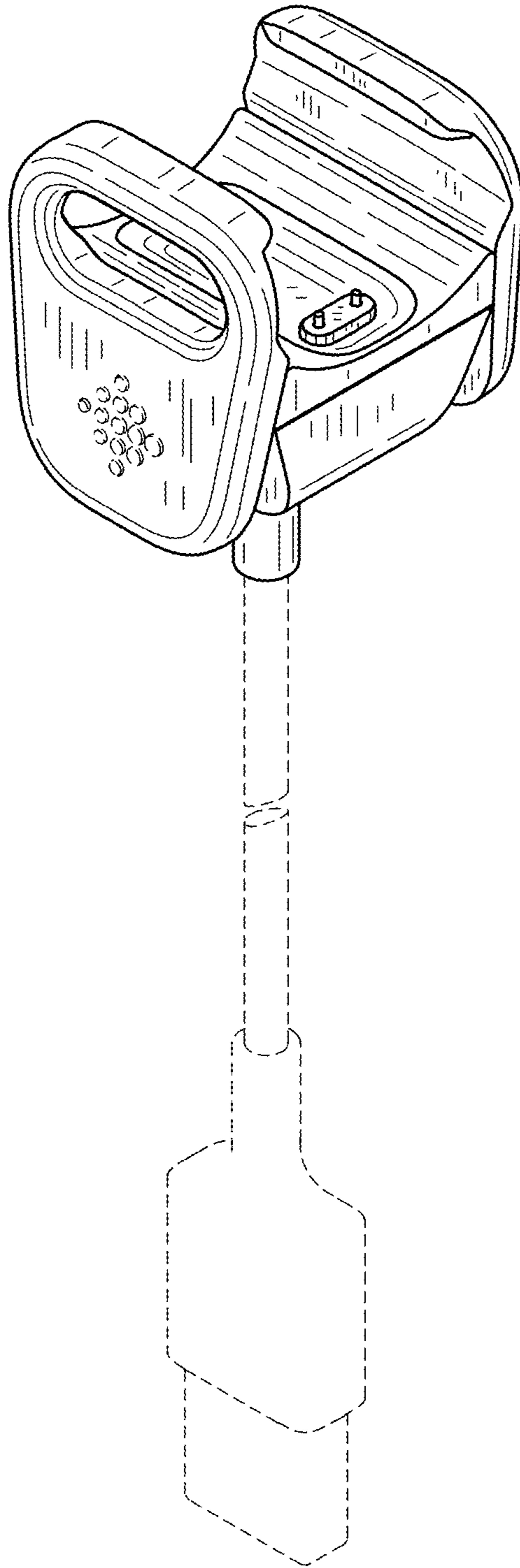

FIG.1

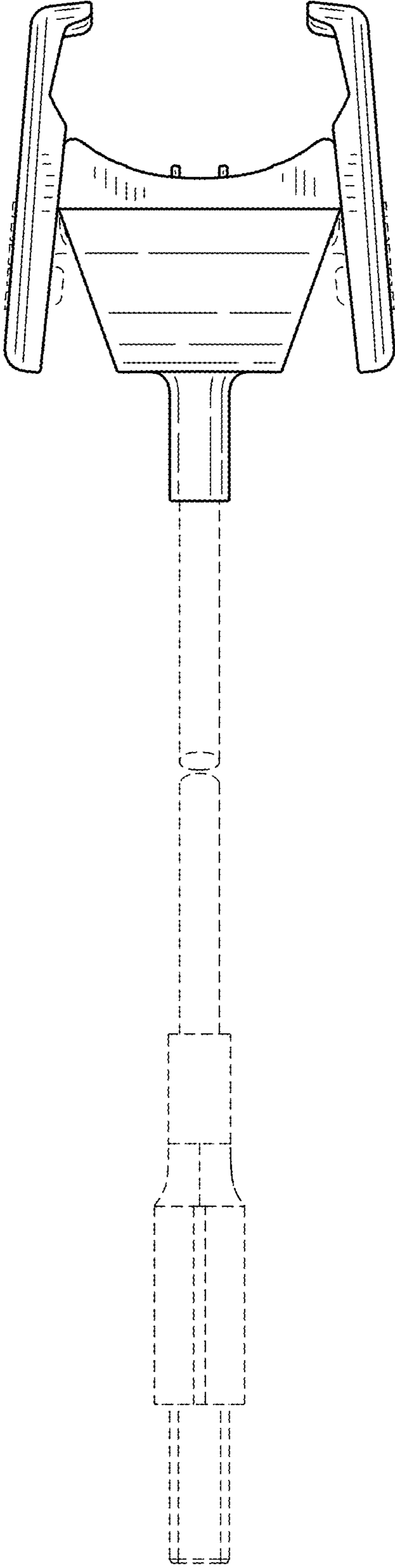

FIG.2

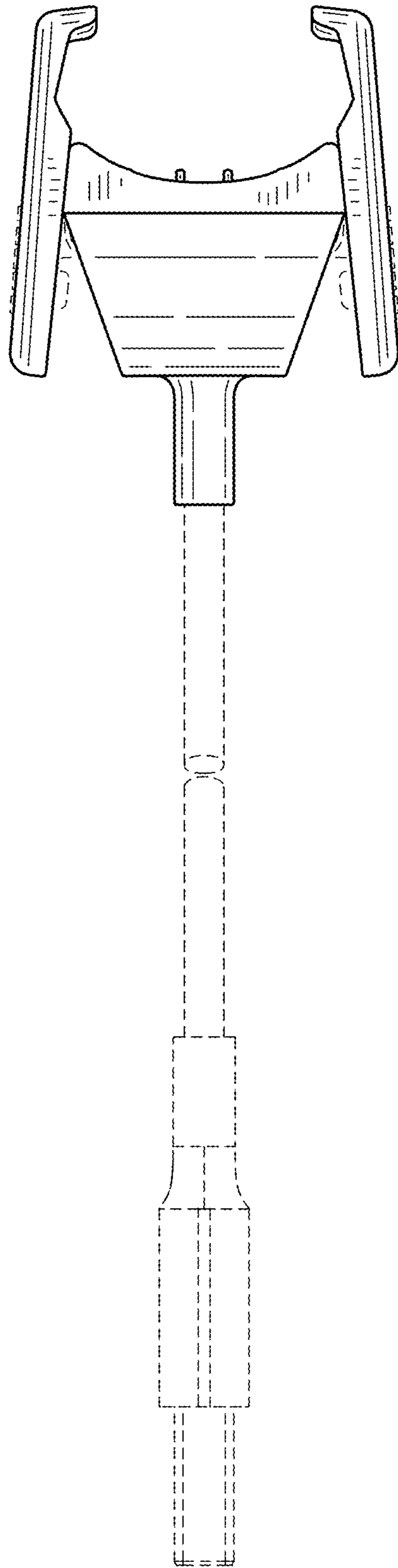

FIG.3

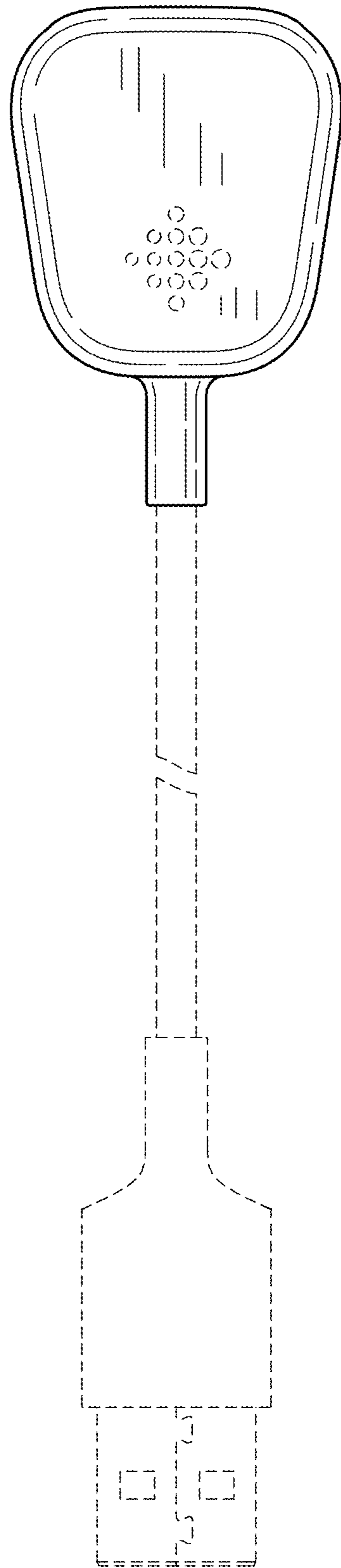

FIG.4

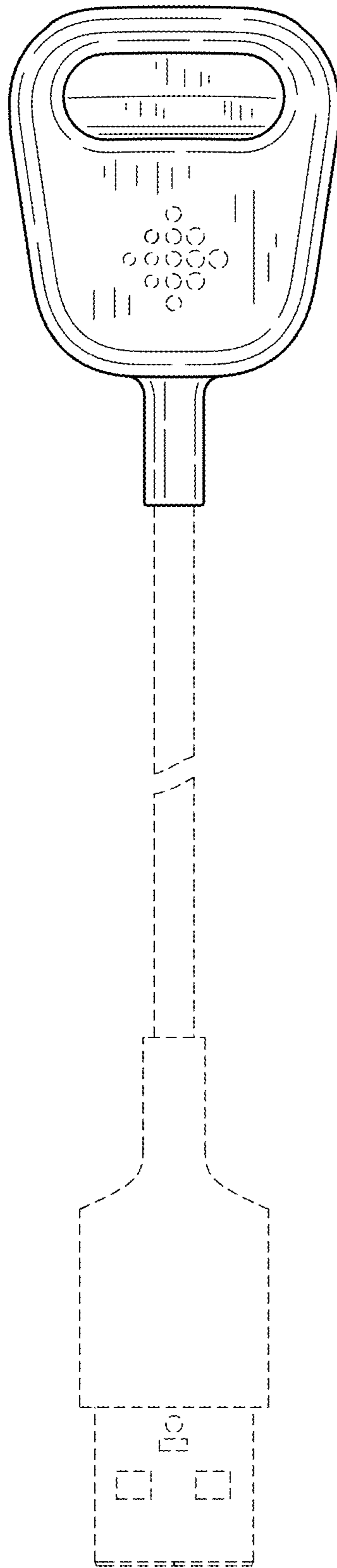

FIG.5

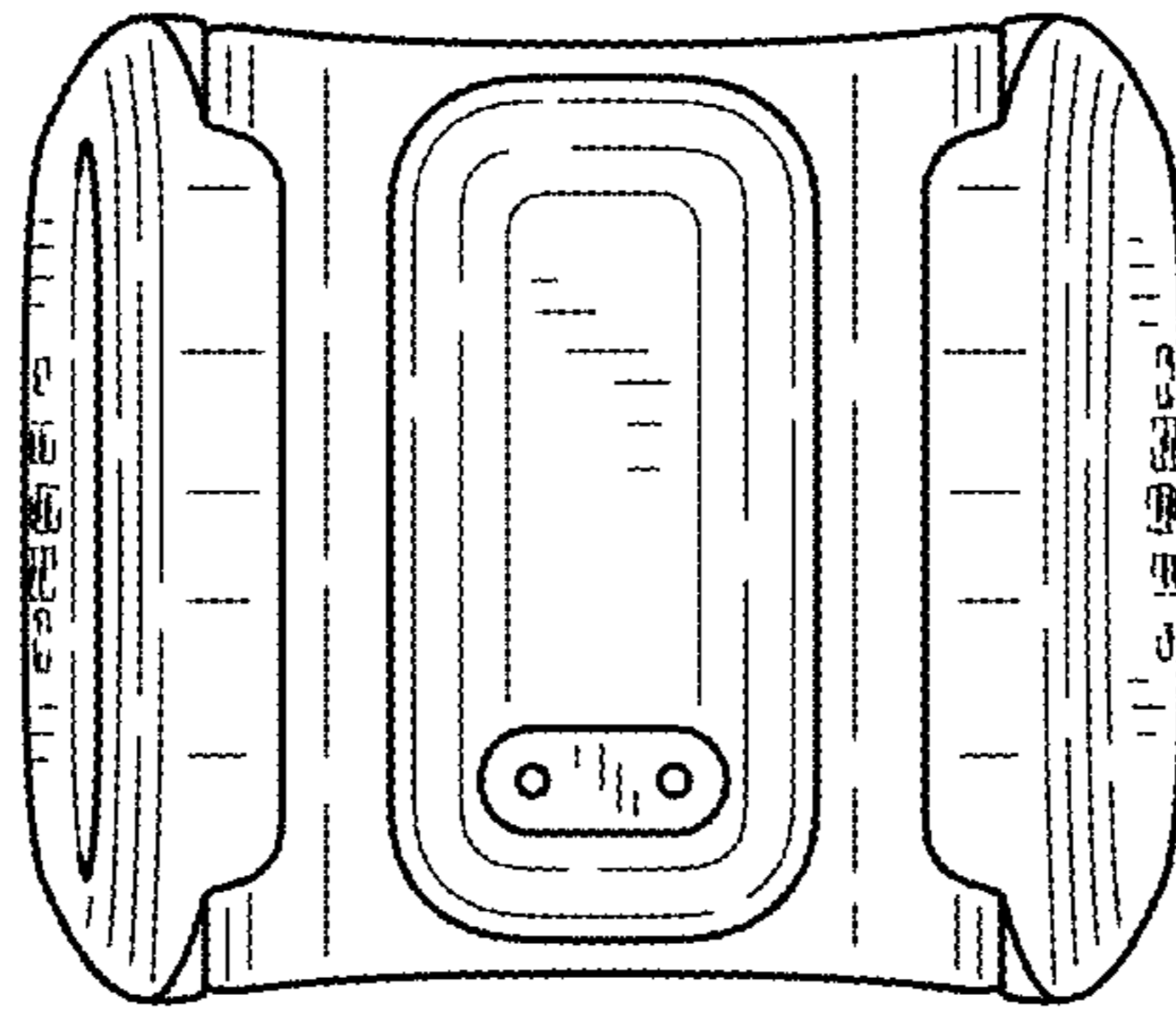

FIG.6

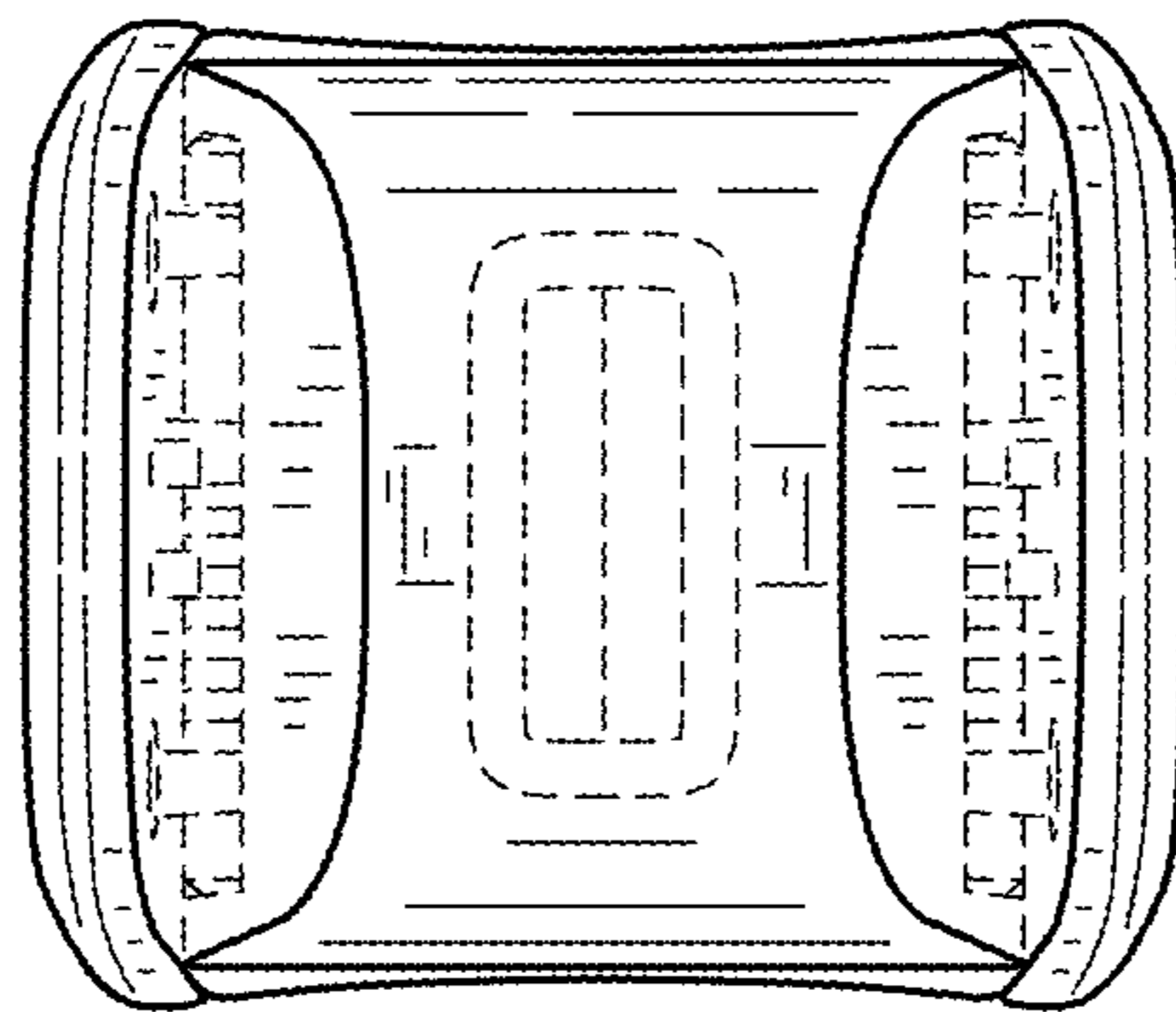

FIG.7