



US00D876978S

(12) **United States Design Patent**
McCarthy

(10) **Patent No.:** **US D876,978 S**
(45) **Date of Patent:** **** Mar. 3, 2020**

(54) **WRIST BAND**
(71) Applicant: **Lydia McCarthy**, Lockport, NY (US)
(72) Inventor: **Lydia McCarthy**, Lockport, NY (US)
(**) Term: **15 Years**
(21) Appl. No.: **29/659,152**
(22) Filed: **Aug. 7, 2018**
(51) **LOC (12) Cl.** **11-01**
(52) **U.S. Cl.**
USPC **D11/4**
(58) **Field of Classification Search**
USPC D11/1-6, 9-20, 40-45, 48, 78.1, 79, 80,
D11/81, 86, 87, 93, 94; D10/32, 37;
116/321, 322; D19/1-8
CPC A44C 5/14; A44C 5/0053; A44C 5/0069;
A44C 5/0076; A44C 5/00; A44C 5/0007;
A44C 5/0015; A44C 5/0023; A44C
5/003; A44C 5/0061; A44C 5/12; A44C
5/147; A44C 5/18; A44C 5/185; A44C
5/2047; A44C 5/2052; A44C 11/00; A44C
11/002; A44C 7/002; A44C 7/003; A44C
7/004; A44C 7/005; A44C 7/006; A44C
7/007; A44C 7/008; A44C 7/009; A44C
15/005; A44C 15/0055; A44C 23/00;
A44C 25/008; A44C 5/04; A44C 5/06;
A44C 5/08; A44C 5/10; A44C 5/022;
A44C 5/025; A44C 5/027; A44C 5/102;
A44C 5/105; A44C 5/107; G06M 1/24;
G09F 3/005
See application file for complete search history.

(56) **References Cited**
U.S. PATENT DOCUMENTS
3,034,189 A * 5/1962 Twentier A44C 5/18
2/322
3,996,879 A 12/1976 Walton
4,557,215 A * 12/1985 Petersson A63B 71/0672
116/222
D290,582 S * 6/1987 Angerman D9/415

4,682,431 A * 7/1987 Kowalchuk G09F 3/005
40/633
4,877,119 A 10/1989 Hosking
D354,221 S * 1/1995 Corella D9/415
5,607,078 A 3/1997 Nordberg
5,644,298 A 7/1997 Brooks
5,845,777 A 12/1998 Najmi
D404,969 S 2/1999 Krenzler
D415,976 S * 11/1999 Be D11/4
D442,113 S * 5/2001 Nisguretsky D11/86
D477,500 S 7/2003 Smith
6,884,077 B2 * 4/2005 Faulkner G09B 19/02
434/188
D505,353 S * 5/2005 Del Valle D11/3
(Continued)

OTHER PUBLICATIONS

MyID Sport Medical Alert ID Bracelet, Dec. 9, 2017, [online], [site visited Dec. 9, 2019]. Retrieved from url:https://shop.getmyid.com/collections/neon-series/products/myid-sport-medical-id?variant=31406851457163 (Year: 2017).*

Primary Examiner — Jeffrey D Asch
Assistant Examiner — Tracey J Bell

(57) **CLAIM**

I claim the ornamental design for a wrist band, as shown and described.

DESCRIPTION

FIG. 1 is a front view of the wrist band.
FIG. 2 is a rear view of the claimed design.
FIG. 3 is a left side view of the claimed design.
FIG. 4 is a right side view of the claimed design.
FIG. 5 is a top view of the claimed design.
FIG. 6 is a bottom view of the claimed design; and,
FIG. 7 is a perspective view of the claimed design.
The broken lines appearing on FIGS. 1, 2, 3, 4, and 7 of numerals and wording “Hydro-Band” are environmental matter forming no part of the claimed design.

1 Claim, 4 Drawing Sheets

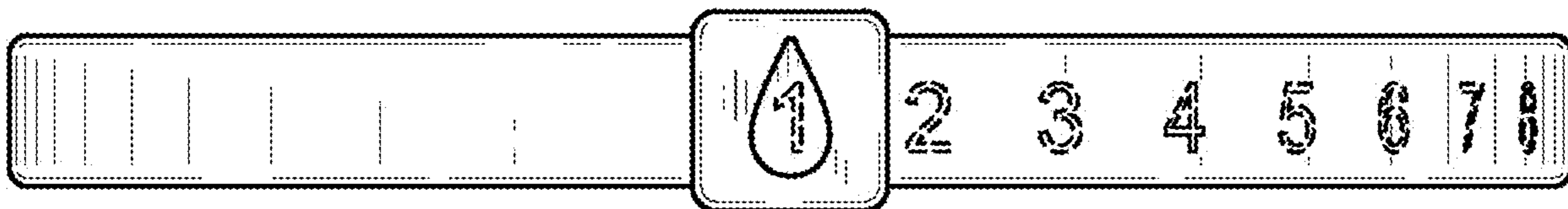

(56)

References Cited

U.S. PATENT DOCUMENTS

D587,158 S * 2/2009 Trapani D11/78.1
D591,633 S * 5/2009 Del Valle D11/3
D726,057 S * 4/2015 Wai D11/4
D765,534 S * 9/2016 Schone D11/3
9,855,193 B2 * 1/2018 O'Doherty A61J 7/04
D826,776 S * 8/2018 Grunewald D11/216
D831,523 S * 10/2018 Barley D11/4
2006/0179542 A1 * 8/2006 Pierce A44C 15/0025
2/170
2008/0261187 A1 * 10/2008 Pierce A44C 5/0015
434/238
2010/0300147 A1 12/2010 Farmer
2011/0149693 A1 6/2011 Liao
2014/0070012 A1 * 3/2014 Hunt G06K 19/06037
235/494
2014/0354407 A1 * 12/2014 Evans G06C 3/00
340/6.1

* cited by examiner

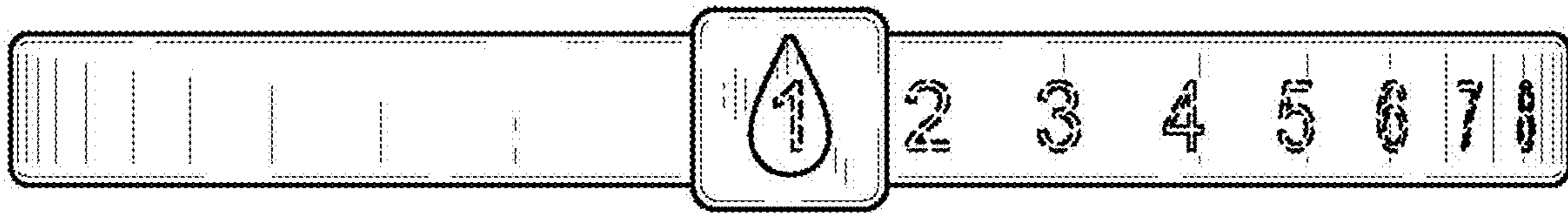

FIG. 1



FIG. 2

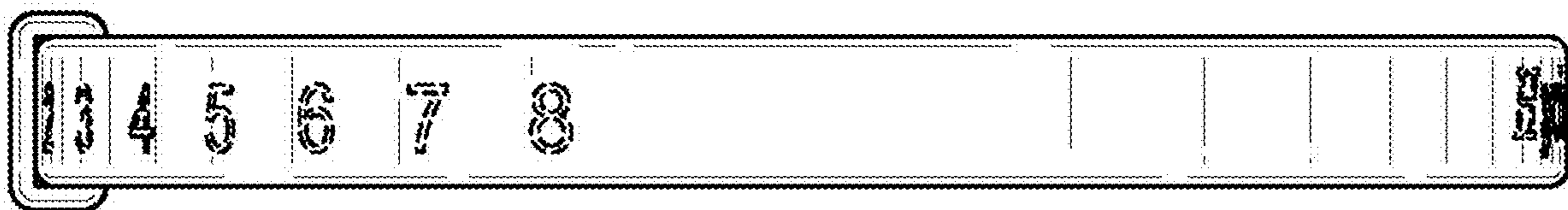

FIG. 3

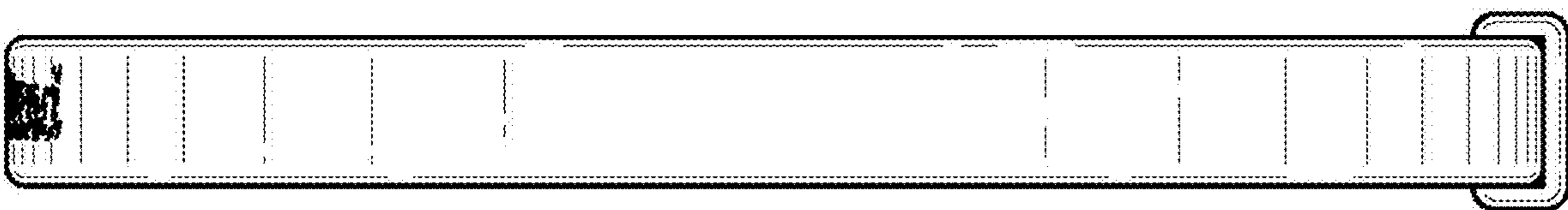

FIG. 4

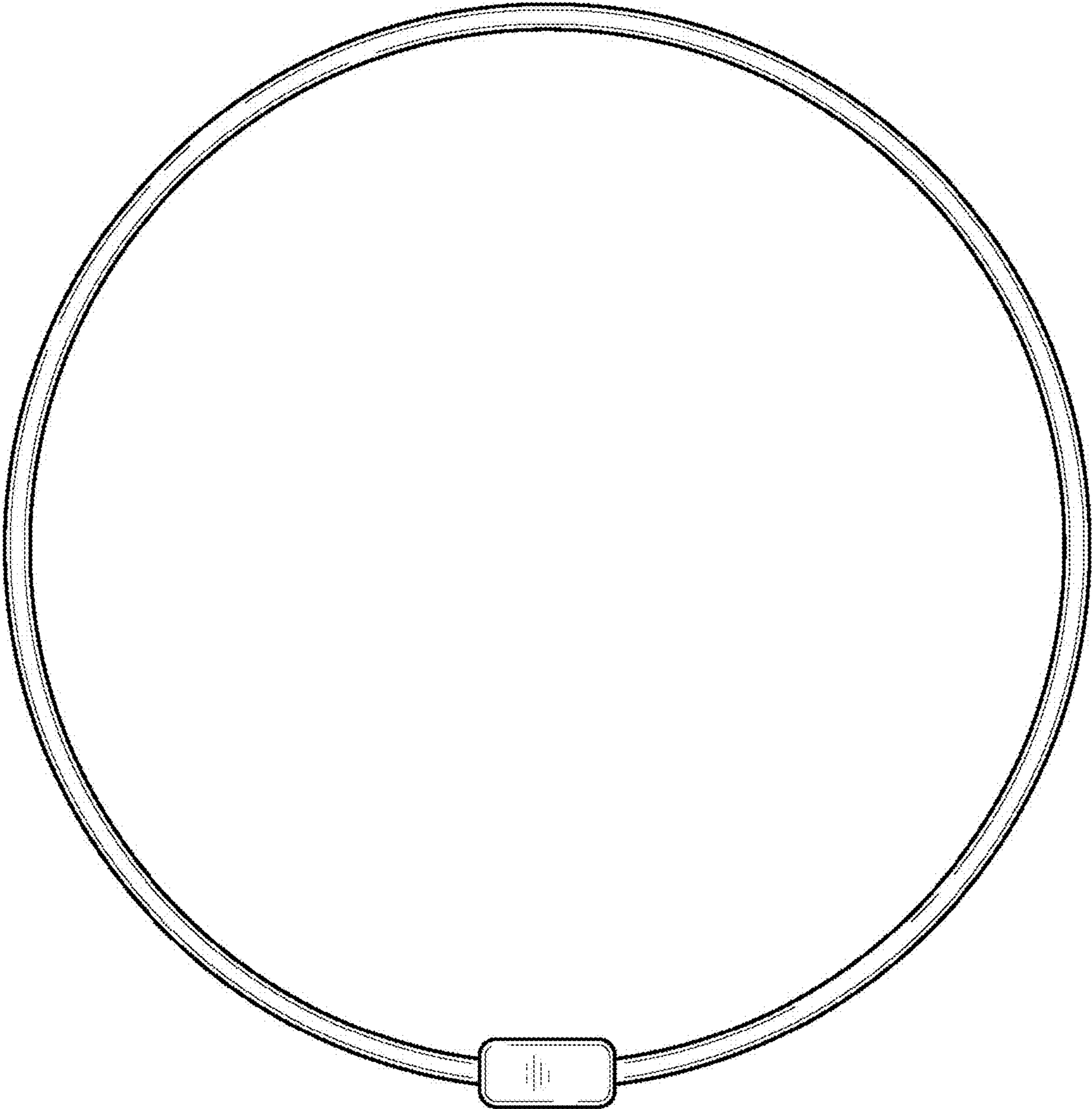

FIG. 5

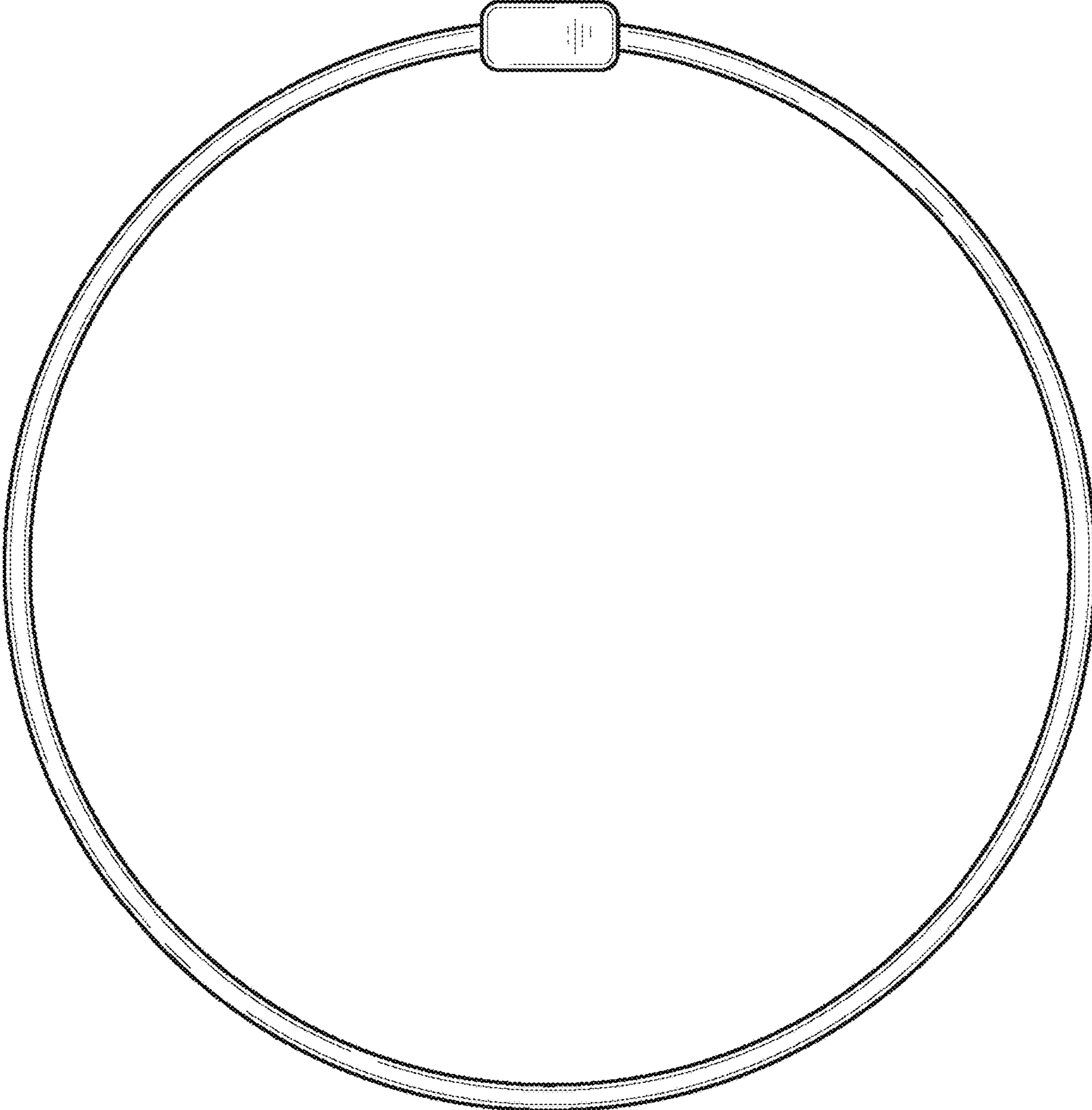

FIG. 6

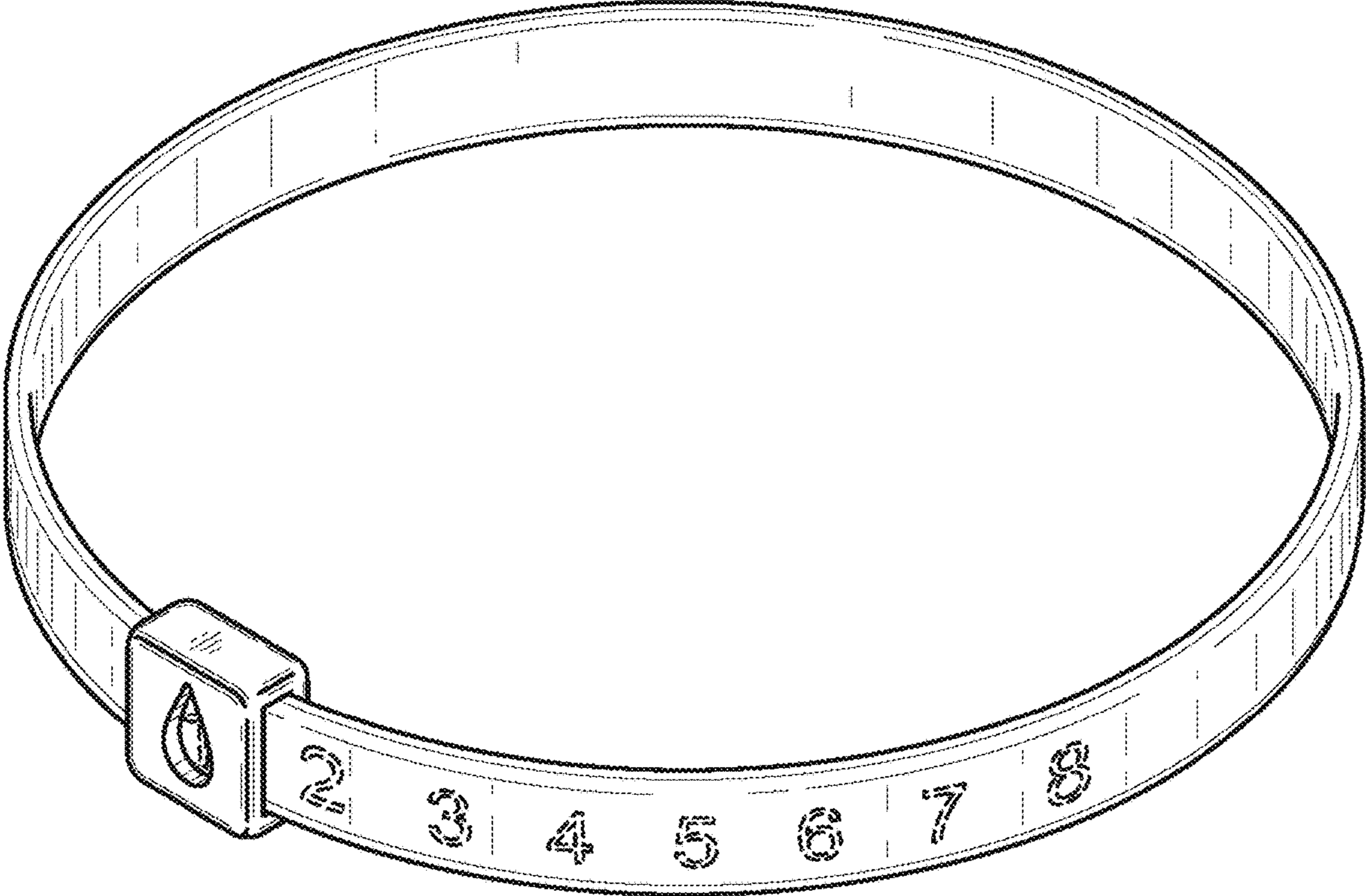

FIG. 7